

# SAFETY AND PRODUCTIVITY

## DESIGN

With features like offset and ergonomic handles to low swing arc ratchets to maximize your productivity

## QUALITY

From chrome vanadium steel to hardened teeth and cutting edges to shatter-resistant handles, we use only the best materials

## STANDARDS

Our tools meet or exceed international standards to ensure you get the job done right the first time

# HAND TOOLS

## DID YOU KNOW?

Many of our products are clearly labeled and colour coded to ensure you use the right product for the right application



# TABLE OF CONTENTS

Table of Contents.....	8-9	Icon Legend.....	10
------------------------	-----	------------------	----

## Tool Storage and Organizers 11

Portable Tool Boxes.....	12	Open Front Tool Chests.....	28
Chests and Roller Cabinets.....	13-21	Service Carts.....	30-31
Job Site Tool Storage.....	21	Shop Carts.....	32
Tool Bags.....	22-25	Workbenches.....	33
Chests and Roller Cabinets.....	26-27	Tool Organizers.....	34-36

## Ratchet Wrenches 37

1/4", 3/8" & 1/2" Drive.....	38-42	3/4" & 1" Drive.....	43-44
------------------------------	-------	----------------------	-------

## Chrome Sockets 45

<b>Socket Wrench Sets</b>		<i>TORX®</i> Bits.....	62
1/4" Drive.....	46-47	External <i>Torx®</i> .....	63
3/8" Drive.....	48-49	3/8" Drive Spark Plug Sockets.....	64
1/2" Drive.....	50-51	<b>Open Stock</b>	
3/4" Drive.....	52	SAE.....	64-65
1" Drive.....	53	Metric.....	66-67
<b>Sockets Sets</b>		SAE Hex Bits.....	68
1/4" Drive.....	54	Metric Hex Bits.....	69
3/8" Drive.....	55-56	<i>TORX®</i> Bits.....	70
1/2" Drive.....	57-58	External <i>TORX®</i> .....	70
3/4" Drive.....	59	Socket Accessories.....	71-76
Hex Bits.....	60-61	Extension bars.....	74-76

## Impact Sockets 77

<b>Sockets Sets</b>		1/2" Drive <i>TORX®</i> Bit.....	88
3/8" Drive.....	78	1/2" Drive Hex Bit.....	88
1/2" Drive.....	79-81	3/4" Drive Hex Bit.....	89
1/2" Drive Universal.....	82	3/8" & 1/2" Drive External <i>TORX®</i> .....	89
Mag Wheel Sockets.....	82	Socket Accessories.....	90-91
Torque Limiting Extensions.....	83	<b>Open Stock</b>	
3/4" Drive.....	84-85	SAE.....	92
1" Drive.....	85-86	Metric.....	93
1" Drive Truck Tire.....	87	Hex & <i>TORX®</i> Bits.....	94

## Wrenches 95

<b>Combination Wrenches</b>		Ratchet Wrenches - Multi-fit.....	106
Raised Panel.....	96-97	Flare Nut Wrenches.....	107
Fully Polished.....	98-99	Crowfoot Wrenches.....	107
Multi-Fit.....	100	Adjustable Wrenches.....	108-109
Stubby Polished.....	101	Striking Wrenches.....	110
Ratchet Wrench Sets.....	102-104	Structural Wrenches.....	111
Ratchet Wrenches Open Stock.....	105	Adjustable Spanner Wrenches.....	112

## Hex Key Wrenches 113

<b>Hex Key Wrenches</b>		<b>Open Stock</b>	
Folding Sets.....	114	Hex Key Wrenches.....	119-120
Sets.....	114-118	<i>TORX®</i> Key Wrenches.....	120

## Torque Wrenches 121

Torque Wrenches.....	122-124	Torque Multipliers.....	126
Digital Torque Wrenches.....	125		

## Screwdrivers 127

<b>Jumbo Handle Series</b>		<b>Cushion Grip Screwdrivers</b>	
Sets.....	128	Sets.....	134
Open Stock.....	129	Open Stock.....	135
<b>Torque Drive® Series</b>		Cushion Grip Multi-Bit Driver Sets.....	136
Sets.....	130	Multi-Bit Driver Set.....	136
Open Stock.....	131	Ratcheting Drivers.....	137-139
<b>Ergonomic Screwdrivers</b>			
Sets.....	132		
Open Stock.....	133		

## Screwdriver Bits 140

Insert Bits.....	140	Nutsetters.....	141
Power Bits.....	141		

## Nut, Precision and Impact Drivers 142

<b>Cushion Grip Nut Drivers</b>		<b>Jumbo Handle Series</b>	
Sets.....	142	Sets.....	143
Open Stock.....	142	Open Stock.....	143
		Precision Screwdriver Sets.....	144
		Impact driver.....	144

## Pliers and Cutters 145

<b>Locking Pliers</b>		Long Reach Series.....	151
Sets.....	146	Chrome Vanadium - Open Stock.....	152
Open Stock.....	146-148	<b>Chrome Nickel</b>	
<b>Snap Ring Pliers</b>		Sets.....	153
Sets.....	149	Open Stock.....	154-155
Open Stock.....	149	Shears.....	156-157
<b>Chrome Vanadium</b>		Wire Strippers and Cutters.....	158
Sets.....	150	Utility Knives.....	159-161
Open stock.....	151	Cutting Tools Replacements.....	162

## Sheet Metal Tools 163

Aviation Snips.....	163-164	Rivet Tools.....	165
---------------------	---------	------------------	-----

## VDE Tools 167

VDE Tool Kits.....	168-169	<b>VDE Nut Drivers</b>	
<b>VDE Screwdrivers</b>		Open Stock.....	171
Open Stock.....	170	<b>VDE Pliers and Cutters</b>	
		Open Stock.....	171

## Pipe Tools 173

Pipe Wrenches.....	174-175	Deburring Tools.....	178
Tube Cutters.....	176-177	Ratcheting PVC Pipe Cutter.....	178
Pipe Cutter.....	177	Flaring Tools.....	179-180
Tube Bender.....	177		

## Striking Tools 181

<b>Hammers</b>		Welding Hammer.....	189
Nailing Hammers.....	182-183	Axes and Mauls.....	189
Ball Pein Hammers.....	184-185	Soft Face Dead Blow Hammers.....	190-191
Club Hammer.....	185	<b>Punch and Chisel</b>	
Indestructible Handle Hammers.....	186-187	Sets.....	192-193
Sledge Hammers.....	188	Open Stock.....	194-196
Drilling Hammers.....	188	Stamps - Number / Letter.....	197
Rubber Mallets.....	189		

## Construction Tools 199

Bars - Powerclaw™ Series.....	200-202	Staplers and Tackers.....	209-210
Bolt & Rod Cutters.....	203-204	Hacksaw Frames.....	211
Measuring Tools.....	205-208		

## Shop Equipment 213

<b>Clamping</b>		<b>Shop Equipment</b>	
C-Clamps.....	214-15	Vises.....	219-221
L-Clamps.....	216-217	Pallet Truck.....	222
Pipe Clamps.....	218	Scissor Lift Hand Cart.....	223
Spring Hand Clamps.....	218	Parts Washers.....	224
		Creepers.....	225
		Roller seats.....	226
		Anti-Fatigue Mats.....	227



## Metal Working Machinery 229

Bench grinders.....	230	Drill Presses.....	231-233
Optional Accessories.....	230	Metal Cutting Bandsaws.....	234-235

## Gear Pullers 237

Specialty Pullers.....	238-239	Bearing Separators.....	239
------------------------	---------	-------------------------	-----

## Lubrication / Fluid Transfer 241

Grease Guns.....	242-244	Grease Pump Accessories.....	251
Grease Gun Hoses.....	245	Water, Chemical and Oil Pumps.....	252-253
Quick Change Coupler Adapters.....	246	Oil and Fuel Pumps.....	253-255
Grease Gun Couplers.....	247	Fuel and Gasoline Pumps.....	256-257
Grease Gun Holders.....	247	Oil Drains.....	258-259
Grease Fittings.....	248-249	Drum Handling.....	260
Grease Pumps.....	250		

## Specialty Automotive 261

### Brake Service

Brake Repair Tools.....	262	Flaring Tool Kits.....	264-265
Tube Benders & Cutters.....	263	Brake Repair Tools.....	265

### Hones

Cylinder Hones - Abrasive.....	266
--------------------------------	-----

### Bearing and Bushing Tools

Bearing Packers.....	267	Truck Wheel Bearing Locknut Sockets.....	268
Front Wheel Drive Axle Nut Tools.....	268		

### Suspension/Drive Train Repair

Four Wheel Drive Spindle Locknut Tools.....	269-270	Front End Service Tools.....	270-273
---	---------	------------------------------	---------

### Cooling System

Hose and Clamp Tools.....	274-275	Fan Clutch Wrenches.....	276
Drive Belt Tools.....	275		

### Engine System

Compression and Pressure Testers.....	277-280	Valve Lapping Tools.....	282
Piston Ring Tools.....	281	Tune-Up Tools.....	282
Head and Valve Repair.....	281		

### Exhaust

Exhaust Tools.....	283	Pressure Testers.....	283
--------------------	-----	-----------------------	-----

### Fuel/Injection System

Fluid Line Tools.....	284-285	Pressure Testers.....	286
-----------------------	---------	-----------------------	-----

### Sensor and Sender Units

Open Stock Sockets.....	287
-------------------------	-----

### Hand Tools

Blow Guns.....	288	Hand Brush.....	292
Pullers and Puller Kits.....	288-290	Scrapers.....	293
Gear Pullers.....	291	Seal Puller.....	293
Bearing Separators.....	291	Feeler Gauges.....	294
Gear Pullers.....	292		

### Oil Filter/Drain Plug Tools

Oil Filter Wrenches.....	295-296
--------------------------	---------

### Fastener Tools

Driver Bits And Sockets.....	297	Screwdrivers.....	298
Stud, Bolt And Nut Removal.....	297	Screw Extractors.....	298
Punches - Brass.....	297	Taps, Dies and Thread Repair.....	299
Pliers.....	297		

### Battery Service

Post and Terminal Service.....	300	Testing Equipment.....	301
Battery Carrier.....	300		

### Electrical System

Electric Testers.....	302, 305	Spark Plug/Ignition Tools.....	303-304
-----------------------	----------	--------------------------------	---------

## Specialty Automotive 261

### Miscellaneous and Magnetic Pick-Up Tools

Miscellaneous.....	306	Magnetic Pick-Up Tools.....	306
--------------------	-----	-----------------------------	-----

### Tire Service

Tire Pressure Gauges.....	307-308	Air Inflator Gauges.....	310
Tire Valve Tools.....	309	Air Chucks.....	310
Pliers for Wheel Weights.....	309		

### Upholstery/Trim Panel Tools

Upholstery Tools.....	311
-----------------------	-----

### Automotive Gauges

Chrome Series - Professional Duty.....	312	Tachometers.....	314
Chrome Series - Heavy Duty and Marine.....	313	Electric Fuel Level Gauge Kit.....	314
Easy-Read Gauge Kits White Face.....	313	HTA Series Replacement Parts.....	314

## Precision Measuring Tools 315

Calipers.....	316	Micrometers.....	318
Indicators.....	317	Gauge.....	319
Magnetic Bases.....	317	Brake and Rotor Tools.....	320

## Electronic Measuring Tools 321

Thermometers.....	321	Meters - Digital.....	323
Multimeters - Digital.....	322		

## Mechanics Tools 325

Chisel Point Scrapers.....	326	Pry Bars.....	328-330
Pick, Hook and Scraper Tools.....	327		

## Master Tool Kits 331

549 Piece Master Tool Kit.....	332-334	211 Piece Mechanic's Starter Tool Kit.....	337-338
306 Piece Intermediate Tool Kit.....	335-337	131 Piece Utility Tool Kit.....	339

## Replacement Parts 340

Replacement Parts.....	340	Cushion Grip Multi-Bit Drivers.....	
Ratchets.....	340-341	Replacement Bits.....	343
Torque Wrenches.....	342	Multi-Bit Drivers Replacement Bits.....	343
Pipe Wrenches.....	342		

## Warranty 344

Warranty Information.....	344
---------------------------	-----



## ICON LEGEND

6 Point		Slotted Screwdriver		Warning Note	
12 Point		Slotted Screwdriver Square Shank		Made in Canada	
A2 Steel		Phillips Screwdriver		Made in USA	
S2 Steel		Square Screwdriver		Ball Bearing Slides	
Includes Case		Hex Screwdriver		New	
Includes Pouch		Torx® Screwdriver		JET Exclusive	
Chrome Molybdenum		Hex Key Head		Super Heavy Duty	
Chrome Nickel		Nut Driver			
Chrome Vanadium		Torx® Socket Head			
Use Eye Protection		External Torx®			







# TOOL STORAGE & ORGANIZERS





842142

842143

842144



842152

842153

842154



842104

842124

842134

## PORTABLE TOOL BOXES

### Plastic

- Extra thick walls stand up to heavy loads
- Resists scratches and dents, won't rust
- Removable tool tray
- Steel hinge pins for long service life
- 19" and 22" models feature bolt-through carrying handles for extra heavy loads
- Recessed handle for easy storage and transport
- V-groove on lid holds small parts
- Twin heavy duty buckles distribute weight evenly
- Can be padlocked for security

PROD. NO.	MOD. NO.	Width	Depth	Height	Tray Size
842142	JPTB-16	16"	8"	7-1/2"	13-1/2 x 5"
842143	JPTB-19	19"	9"	8"	16-1/4 x 6"
842144	JPTB-22	22"	10-1/4"	9-1/2"	19 x 7-1/4"

### Stainless Steel/Plastic - Heavy Duty

- Combination of stainless steel and plastic components offers great strength with low weight
- Will not rust
- Removable tool tray
- Steel hinge pins for long service life
- Recessed handle for easy storage and transport
- Twin heavy duty steel buckles distribute weight evenly
- Can be padlocked for security

PROD. NO.	MOD. NO.	Width	Depth	Height	Tray Size
842152	JPSTB-15	15"	6-1/4"	7"	13-1/2" x 4-1/2"
842153	JPSTB-20	20"	9-5/8"	8-7/8"	18" x 6-1/2"
842154	JPSTB-22	22-1/2"	11"	10-3/4"	21" x 8"

### Metal - Heavy Duty

- Heavy gauge powder coated steel for durability
- Rust resistant plated buckles
- Padlock or key lock

PROD. NO.	MOD. NO.	Width	Depth	Height	Overall Weight
842104	TB21	21"	8-3/4"	9"	11 lb
842105	TB26	26"	8-3/4"	9"	14 lb
842124	TB21-3	21"	8-3/4"	12"	23 lb
842134	CTB21-4	21-1/4"	8-3/4"	12"	16 lb



# CHESTS AND ROLLER CABINETS

## SUMO® Series



- SUMO® Series tool storage for professional applications
- Double wall steel construction with reinforced bottom channel on cabinets
- Ball bearing slides on all drawers
- Extruded aluminum drawer pulls
- Heavy duty casters
- Larger chests complete with gas struts for easy opening (42" and 56" only)
- All models complete with drawer liners

### SUMO® Series Mechanics Chest - 27" x 18" 6 Drawers 842553 / SMC2706

	Width	Depth	Height	Overall Weight
<b>OVERALL</b>	26"	17-7/8"	18-5/16"	38 lb
<b>6 DRAWERS</b>	23"	16"	2"	

Maximum Load Per Drawer: 75 lb

### SUMO® Series Roller Cabinet - 27" x 18" 7 Drawers 842503 / SRC2707

	Width	Depth	Height	Overall Weight	Wheels
<b>OVERALL</b>	27"	18-3/4"	35-5/8"	97 lb	5" x 1-1/4"
<b>4 DRAWERS</b>	23"	16"	2"		2 swivel
<b>2 DRAWERS</b>	23"	16"	4-1/4"		2 rigid
<b>1 DRAWER</b>	23"	16"	6-7/16"		

Maximum Load Per Drawer: 75 lb

# SUMO®



842503





## CHESTS AND ROLLER CABINETS

### SUMO® Series

\*  
GOOD

842563



842513

# SUMO®

842573



842523



#### Mechanics Chest - 42" x 16" 10 Drawers

842563 / SMC4210

	Width	Depth	Height	Overall Weight
<b>OVERALL</b>	40-7/8"	16"	19-1/4"	121 lb
<b>3 DRAWERS</b>	22-1/2"	14"	1-3/4"	
<b>2 DRAWERS</b>	22-1/2"	14"	3-3/4"	
<b>3 DRAWERS</b>	12-1/8"	14"	1-3/4"	
<b>2 DRAWERS</b>	12-1/8"	14"	3-3/4"	

Maximum Load Per Drawer: 100 lb

#### Roller Cabinet - 42" x 18" 11 Drawers

842513 / SRC4211

	Width	Depth	Height	Overall Weight	Wheels
<b>OVERALL</b>	41-1/2"	18"	39-7/8"	197 lb	5" x 2"
<b>5 DRAWERS</b>	21-7/8"	15"	2-1/4"		2 swivel
<b>1 DRAWER</b>	21-7/8"	15"	4-7/8"		2 rigid
<b>1 DRAWER</b>	36-1/2"	15"	3-7/8"		
<b>2 DRAWERS</b>	12"	15"	2-1/4"		
<b>1 DRAWER</b>	12"	15"	4-7/8"		
<b>1 DRAWER</b>	12"	15"	7-1/2"		

Maximum Load Per Drawer: 100 lb

#### Mechanics Chest - 56" x 24" 6 Drawers

842573 / SMC5606

	Width	Depth	Height	Overall Weight
<b>OVERALL</b>	55-1/2"	23-7/8"	19-1/8"	225 lb
<b>2 DRAWERS</b>	34-5/8"	21-7/8"	4-1/2"	
<b>2 DRAWERS</b>	34-5/8"	21-7/8"	1-5/8"	
<b>1 DRAWER</b>	15-3/8"	21-7/8"	3-5/8"	
<b>1 DRAWER</b>	15-3/8"	21-7/8"	8-3/4"	

Maximum Load Per Drawer: 100 lb

#### Roller Cabinet - 56" x 24" 10 Drawers

842523 / SRC5610

	Width	Depth	Height	Overall Weight	Wheels
<b>OVERALL</b>	56-3/8"	24"	39-1/2"	359 lb	5" x 2"
<b>1 DRAWER</b>	51-3/8"	20-15/16"	3-1/2"		4 swivel
<b>2 DRAWERS</b>	34-1/8"	20-15/16"	1-11/16"		2 rigid
<b>2 DRAWERS</b>	34-1/8"	20-15/16"	3-5/8"		
<b>1 DRAWER</b>	34-1/8"	20-15/16"	4-1/4"		
<b>3 DRAWERS</b>	15"	20-15/16"	1-11/16"		
<b>1 DRAWER</b>	15"	20-15/16"	11-1/8"		

Maximum Load Per Drawer: 100 lb



# CHESTS AND ROLLER CABINETS

## SUMO® Series Side Lockers



- Tall side lockers offer storage for larger tools too high for regular drawers
- Full height design for use with cabinet and chest combinations
- Both lockers include 2 adjustable shelves
- 42" series locker includes one roller bearing drawer

# SUMO®

### 42" Side Locker 842542 / SL4202

	Width	Depth	Height	Overall Weight
<b>OVERALL</b>	15-1/2"	18-1/4"	52"	72 lb
<b>2 SHELVES</b>	15-1/8"	16-3/4"	3/4"	
<b>1 DRAWER</b>	11-1/8"	15-1/4"	2-3/8"	

Side locker for SRC4211 (842513)



Designed for use with SUMO® Tool Storage units only



Storage drawer

### 56" Side Locker 842543 / SL5602

	Width	Depth	Height	Overall Weight
<b>OVERALL</b>	15-1/2"	24"	51"	66 lb
<b>2 SHELVES</b>	14-7/8"	22-3/8"	5/8"	

Side locker for SRC5610 (842523)



842542





## CHESTS AND ROLLER CABINETS

### Black & Gold Series Mechanic's Chests



- Ball bearing slides on all drawers
- Extra heavy gauge steel construction
- Double walls for maximum strength and weight capacity
- Reinforced base and heavy duty casters on all roller cabinets
- Tool tray included with every 27" top chest
- Nickel plated gold look side handles
- Anti-slip drawer liners
- Protective top mat on roller cabinets
- Push-Lock safety drawers stay closed when moving

#### 26" x 12" 6 Drawers

842652 / MC2606-BG

	Width	Depth	Height	Overall Weight
<b>OVERALL</b>	26"	12"	14-1/2"	49.5 lb
<b>3 DRAWERS</b>	6-3/4"	10-7/16"	1-7/8"	
<b>2 DRAWERS</b>	22-5/8"	10-7/16"	1-7/8"	
<b>1 DRAWER</b>	22-5/8"	10-7/16"	2-7/16"	

Maximum Load Per Drawer: 75 lb



#### 26" x 12" 9 Drawers

842654 / MC2609-BG

	Width	Depth	Height	Overall Weight
<b>OVERALL</b>	26"	12"	16-1/2"	57 lb
<b>6 DRAWERS</b>	6-3/4"	10-7/16"	1-7/8"	
<b>2 DRAWERS</b>	22-5/8"	10-7/16"	1-7/8"	
<b>1 DRAWER</b>	22-5/8"	10-7/16"	2-7/16"	

Maximum Load Per Drawer: 75 lb



#### 26" x 16" 6 Drawers

842653 / MC2606D-BG

	Width	Depth	Height	Overall Weight
<b>OVERALL</b>	26"	15-7/8"	18-3/4"	72.4 lb
<b>5 DRAWERS</b>	22-1/2"	14-3/8"	1-7/8"	
<b>1 DRAWER</b>	22-1/2"	14-3/8"	2-3/8"	

Maximum Load Per Drawer: 75 lb





# CHESTS AND ROLLER CABINETS

Black & Gold Series Roller Cabinets



**27" x 18" 5 Drawers** **842602** / RC2705-BG

	Width	Depth	Height	Overall Weight	Wheels
<b>OVERALL</b>	27"	18-5/16"	31-5/16"	90 lb	5"
<b>3 DRAWERS</b>	23"	14-7/8"	2-7/8"		2 swivel
<b>2 DRAWERS</b>	23"	14-7/8"	6"		2 rigid

Maximum Load Per Drawer 75 lb



**27" x 18" 7 Drawers** **842604** / RC2707-BG

	Width	Depth	Height	Overall Weight	Wheels
<b>OVERALL</b>	27"	18-5/16"	37-5/8"	110 lb	5"
<b>5 DRAWERS</b>	23"	14-7/8"	2-7/8"		2 swivel
<b>2 DRAWERS</b>	23"	14-7/8"	6"		2 rigid

Maximum Load Per Drawer 75 lb





## CHESTS AND ROLLER CABINETS

Black & Gold Series Mechanic's Chests



41" x 18" 14 Drawers

842663 / MC4114-BG

	Width	Depth	Height	Overall Weight
<b>OVERALL</b>	40-5/16"	16"	19-1/8"	137 lb
<b>9 DRAWERS</b>	6-3/4"	14-1/8"	1-7/8"	
<b>2 DRAWERS</b>	22-5/8"	14-1/8"	1-7/8"	
<b>1 DRAWER</b>	22-5/8"	14-1/8"	2-7/16"	
<b>2 DRAWERS</b>	12-3/16"	14-1/8"	5-1/2"	

Maximum Load Per Drawer 100 lb



56" x 24" 9 Drawers

842673 / MC5609-BG

	Width	Depth	Height	Overall Weight
<b>OVERALL</b>	55-1/2"	23-7/8"	19-3/8"	225 lb
<b>7 DRAWERS</b>	25-1/8"	22"	1-7/8"	
<b>1 DRAWER</b>	25-1/8"	22"	4-1/2"	
<b>1 DRAWER</b>	25-1/8"	22"	6-1/2"	

Maximum Load Per Drawer 100 lb



842613-63

842623-73



# CHESTS AND ROLLER CABINETS

Black & Gold Series Roller Cabinets



**41" x 18" 10 Drawers** **842613** / RC4110-BG

	Width	Depth	Height	Overall Weight	Wheels
<b>OVERALL</b>	41-1/8"	18-3/8"	39-1/2"	217 lb	5"
<b>7 DRAWERS</b>	22"	15"	2-7/16"		2 swivel
<b>1 DRAWER</b>	22"	15"	4-7/8"		2 rigid
<b>2 DRAWERS</b>	15-7/8"	15"	2-7/16"		

Maximum Load Per Drawer 100 lb



**41" x 18" 16 Drawers** **842614** / RC4116-BG

	Width	Depth	Height	Overall Weight	Wheels
	41-1/8"	18-5/16"	39-5/8"	232 lb	5"
<b>1 DRAWER</b>	22"	15"	4-7/8"		2 swivel
<b>1 DRAWER</b>	12-1/4"	15"	4-7/8"		2 rigid
<b>7 DRAWERS</b>	22"	15"	2-7/16"		
<b>7 DRAWERS</b>	12-1/4"	15"	2-7/16"		

Maximum Load Per Drawer 100 lb



**56" x 24" 13 Drawers** **842623** / RC5613-BG

	Width	Depth	Height	Overall Weight	Wheels
<b>OVERALL</b>	56"	24"	39-1/2"	446 lb	5"
<b>10 DRAWERS</b>	24-1/2"	21-1/8"	2-7/16"		4 swivel
<b>2 DRAWERS</b>	24-1/2"	21-1/8"	5"		2 rigid
<b>1 DRAWER</b>	51-5/8"	21-1/8"	3-5/8"		

Maximum Load Per Drawer 100 lb







## CHESTS AND ROLLER CABINETS

### Pro Series Mechanic's Chests & Roller Cabinets

\*\*\*  
BEST

- Two piece friction slides provide long service life
- Full width drawer pulls for comfortable, easy operation
- Full width / full height double wall construction for superior rigidity
- Rear locking mechanism provides maximum security
- **Canadian built using the best quality domestic steel for maximum storage capacity without the risk of bending under heavy loads**

#### 26" x 12" 6 Drawers

842252 / MC26-6

	Width	Depth	Height	Overall Weight
<b>OVERALL</b>	26"	12"	14-1/2"	55 lb
<b>3 DRAWERS</b>	7"	10-1/2"	2"	
<b>2 DRAWERS</b>	23"	10-1/2"	2"	
<b>1 DRAWERS</b>	23"	10-1/2"	2-1/2"	

Maximum Load Per Drawer 75 lb



#### 26" x 18" 12 Drawers

842254 / MC26-12

	Width	Depth	Height	Overall Weight
<b>OVERALL</b>	26"	17-7/8"	20-1/2"	105 lb
<b>9 DRAWERS</b>	7"	16"	2"	
<b>2 DRAWERS</b>	23"	16"	2"	
<b>1 DRAWER</b>	23"	16"	4-1/4"	

Maximum Load Per Drawer 75 lb



#### 27" x 18" 5 Drawers

842202 / RC27-5

	Width	Depth	Height	Overall Weight	Wheels
<b>OVERALL</b>	27"	18-3/4"	35-5/8"	109 lb	5" x 1-1/4"
<b>4 DRAWERS</b>	23"	16"	4-1/4"		2 swivel
<b>1 DRAWER</b>	23"	16"	6-7/16"		2 rigid

Maximum Load Per Drawer 75 lb



#### 27" x 18" 11 Drawers

842204 / RC27-11

	Width	Depth	Height	Overall Weight	Wheels
<b>OVERALL</b>	27"	18-3/4"	42-3/8"	151 lb	5" x 2"
<b>4 DRAWERS</b>	11"	16"	2"		2 swivel
<b>4 DRAWERS</b>	23"	16"	2"		2 rigid
<b>2 DRAWERS</b>	23"	16"	4-1/4"		
<b>1 DRAWER</b>	23"	16"	8-1/2"		

Maximum Load Per Drawer 75 lb



MADE IN  
CANADA

# CHESTS AND ROLLER CABINETS

## Pro Series Truck Box



- Extra heavy gauge steel and additional spot welds designed to withstand the constant vibration and bumps of road travel
- Drop front cover with neoprene seal prevents water from entering
- Concealed hinges prevent rust
- Black powder coated paint for long term rust resistance
- Full extension friction drawer slides
- Heavy duty welded side handles with 90° stops
- Heavy duty rubber feet keep box out of water

**26" x 18" 5 Drawers** 842256 / TB26-5

	Width	Depth	Height	Overall Weight
<b>OVERALL</b>	26"	17-7/8"	23"	124 lb
<b>3 DRAWERS</b>	23"	16"	2"	
<b>2 DRAWERS</b>	23"	16"	4-1/4"	

Maximum Load Per Drawer 75 lb



## JOBSITE TOOL STORAGE

### Jobsite Tool Storage Box - Super Heavy Duty

- Super Heavy Duty 16 gauge steel body and lid for maximum security
- Robotically welded seams for increased strength
- Dual recessed lock housings prevent use of bolt cutters or blades to cut locks
- Staked and welded piano hinge prevents hinge pin from being driven out
- Overlapping lid prevents leaks and features full width reinforcing bolster for added strength
- Finger groove in lid for easy opening even with gloves
- Heavy duty lid prevents accidents
- 12 gauge 4-way skids allow forklift access from front, back, and both sides for increased transportation options
- Skids are predrilled to accept optional 6" x 2" heavy duty casters
- High visibility orange powder coat for superior corrosion resistance
- Made in Canada!

**Jobsite Tool Box - 32" x 19"** 842480 / JSB-3219

	Width	Depth	Height (without wheels)	Overall Weight
<b>OVERALL</b>	32-1/8"	19"	17-1/2"	70 lb

Shipping Weight: 72 lb

**Jobsite Tool Box - 48" x 24"** 842481 / JSB-4824

	Width	Depth	Height (without wheels)	Overall Weight
<b>OVERALL</b>	48-1/8"	24-1/8"	28-3/8"	136 lb

Shipping Weight: 140 lb



**SITE SAFE**



MADE IN CANADA





## TOOL BAGS

- Premium quality 1680D polyester material for professional applications
- Reinforced with double stitching and steel rivets in all critical weight bearing areas for years of worry free use
- Chrome plated and stainless steel components resist corrosion
- Complete with padded shoulder strap for easy transport



### 16" Open Top Tool Bag

842001/ JOTB-16

- 5 exterior pockets and 18 interior pockets for organizing small tools
- Large interior space holds power tools and larger items
- Two hook and loop straps secure levels or other long tools to top of bag
- Double riveted stainless steel tube handle with PVC grip for comfort
- Removable cover protects tools from the elements
- Plastic skids on bottom keep fabric off the ground
- Includes 2 plastic organizer boxes
- Interior size 16" x 8" x 7"
- Overall size 20" x 10" x 10"

**NEW**



### 24" Open Top Tool Bag

842002/ JOTB-24

- 6 exterior pockets and 36 interior pockets for organizing small tools
- Large interior space holds power tools and larger items
- Two hook and loop straps secure levels or other long tools to top of bag
- Double riveted stainless steel tube handle with PVC grip for comfort
- Removable cover protects tools from the elements
- Plastic skids on bottom keep fabric off the ground
- Interior size 24" x 10" x 11"
- Overall size 24" x 12" x 12"

**NEW**



### 16" Zip Top Tool Bag

842006/ JZTB-16

- Self-repairing zipper keeps tools secure
- Steel reinforcement rods keep mouth of bag open for convenience
- 10 exterior pockets and 14 interior pockets for organizing tools
- 8 exterior tool holders for added storage
- Large interior space holds power tools and larger items
- Two straps secure levels or other long tools to side of bag
- Double stitched padded carrying handle
- Synthetic rubber bottom protects bag from water and chemicals
- Interior size 16" x 8" x 11"
- Overall size 16" x 9" x 12"

**NEW**

\* Tools not included



## TOOL BAGS

### 8" Square Tool Bag

842011/ JSTB-8

- 5 exterior pockets and 18 interior pockets for organizing small tools
- Large interior space holds power tools and larger items
- Plastic skids on bottom keep fabric off the ground
- Includes 1 plastic organizer box
- Overall size 8-1/2" x 8-1/2" x 9-1/2" (not including handle)

**NEW**

### Tool Back Pack

842016/ JTBP-100

- Large main compartment features 22 pockets, 9 elastic loops, and 1 large zipper pocket for organizing tools
- Secondary compartment features 18 pockets for added capacity
- Outside of back pack features large zipper pocket, cell phone pocket, water bottle holder, and luggage tag holder
- Padded adjustable shoulder straps feature non-slip material to help keep pack from sliding down
- Thick padding on back of pack for user comfort
- Synthetic rubber feet protect pack from water and chemicals

**NEW**

**YOUR TOOLS  
DESERVE TO BE  
CARRIED  
IN ONE OF THESE**



\* Tools and bottle not included



## TOOL BAGS

### 45 Pocket Bucket Organizer

842096/JBO-45

- 900 D polyester material for professional applications
- Double stitched for years of worry free use
- Turns any 5 gallon bucket into a heavy duty tool organizer
- Various sized pockets hold a wide variety of tools and equipment

**NEW**



### 56 Pocket Bucket Organizer

842097/JBO-56

- Premium quality 1680D polyester material for professional applications
- Double stitched for years of worry free use
- Turns any 5 gallon bucket into a heavy duty tool organizer
- Various sized pockets hold a wide variety of tools and equipment

**NEW**



*\* Bucket and tools not included*



## 2 Pouch Tool Belt

842091/JTB-2

- Premium quality 1680D polyester material for professional applications
- Double stitched for years of worry free use
- 2 pouches each feature 5 interior pockets, 2 exterior pockets, 3 tool holder loops, 1 nail pocket and one hammer loop
- Includes measuring tape holder
- Heavy duty padded belt with hook and loop closure
- Pouches suspended with separate web belt with quick release buckle

**NEW**



## Tool Pouch

842092/JTP-1

- Premium quality 1680D polyester material for professional applications
- Double stitched for years of worry free use
- Pouch features 4 elastic tool holders in main pocket, 4 exterior pockets and 4 exterior tool holders
- Carabiner and tape strap with locking swivel hook
- Can be attached to any tool belt using sewn loop or steel clip

**NEW**



*\* Tools not included*







## TREASURE SERIES



## TOOL CHESTS AND ROLLER CABINETS

### Treasure Series

\*\*\*  
BEST

Unique styling stands out in any garage or shop! Drop down trays on chest and flip up trays on cabinet provide plenty of work space. Full width aluminum drawer pulls feature safe lock latches to prevent drawers opening when moving tool box.\*

- Ball bearing drawer slides with auto close feature ensure drawers are completely closed before locking
- Safe-Lock system prevents drawers from accidentally opening when moving tool box\*
- Recessed handles on both sides do not protrude outside of tool box dimensions – easy to park and move!
- Attractive automotive style casters
- All drawers complete with drawer liners
- 5/8" MDF work surface included with roller cabinets\*
- Secure rear lock mechanism
- Sand finish powder coat paint resists scratches, chemicals, and fingerprints
- A JET Exclusive!

\* Not available on 27" product

**JET**  
EXCLUSIVE

#### Tool Chest 27" x 18" 7 Drawers

842754 / TMC2708

	Width	Depth	Height	Overall Weight
<b>OVERALL</b>	31-5/16"	18-7/8"	40"	159 lb
<b>2 DRAWERS</b>	22-3/8"	15-5/8"	2-7/8"	
<b>5 DRAWERS</b>	22-3/8"	15-5/8"	2-7/8"	

**NEW**

Maximum Load per Drawer 100 lb



#### Roller Cabinet 27" x 18" 8 Drawers

842704 / TRC2707

	Width	Depth	Height	Overall Weight
<b>OVERALL</b>	31-5/16"	18-7/8"	21-1/2"	107 lb
<b>1 DRAWER</b>	22-3/8"	15-5/8"	2-7/8"	
<b>3 DRAWERS</b>	6-5/8"	15-5/8"	2"	
<b>4 DRAWERS</b>	22-3/8"	15-5/8"	2"	

**NEW**

Maximum Load per Drawer 100 lb



# TOOL CHESTS AND ROLLER CABINETS

Treasure Series



## TREASURE SERIES

### Tool Chest - 41" x 18" 8 Drawers 842762 / TMC4208

	Width	Depth	Height	Overall Weight
<b>OVERALL</b>	45-3/4"	18-15/16"	21-5/16"	138 lb
<b>4 DRAWERS</b>	22-7/16"	15-5/8"	2-15/16"	
<b>4 DRAWERS</b>	12-3/16"	15-5/8"	2-15/16"	
<b>2 SHELVES</b>				

Maximum Load per Drawer 100 lb



### Roller Cabinet - 41" x 18" 11 Drawers 842712 / TRC4211

	Width	Depth	Height	Overall Weight
<b>OVERALL</b>	45-3/4"	18-15/16"	40-1/16"	259 lb
<b>1 DRAWER</b>	36-13/16"	15-5/8"	4-3/4"	
<b>1 DRAWER</b>	22-7/16"	15-5/8"	6-1/16"	
<b>1 DRAWER</b>	12-1/8"	15-5/8"	12-5/16"	
<b>3 DRAWERS</b>	12-1/8"	15-5/8"	2-5/16"	
<b>5 DRAWERS</b>	22-7/16"	15-5/8"	2-15/16"	
<b>2 SHELVES</b>				

Maximum Load per Drawer 100 lb



### Tool Chest - 53" x 19" 8 Drawers 842772 / TSMC5308

	Width	Depth	Height	Overall Weight
<b>OVERALL</b>	52-13/16"	18-7/8"	21-1/4"	166 lb
<b>4 DRAWERS</b>	29-5/8"	15-5/8"	3"	
<b>4 DRAWERS</b>	12-1/8"	15-5/8"	3"	
<b>2 SHELVES</b>				

Maximum Load per Drawer 100 lb



### Roller Cabinet - 53" x 19" 12 Drawers 842722 / TSRC5312

	Width	Depth	Height	Overall Weight
<b>OVERALL</b>	53"	19-3/32"	33-7/16"	297 lb
<b>1 DRAWER *</b>	44-1/16"	15-5/8"	4-3/4"	
<b>1 DRAWER *</b>	29-5/8"	15-5/8"	6"	
<b>1 DRAWER *</b>	12-1/8"	15-5/8"	9-1/8"	
<b>4 DRAWERS</b>	12-1/8"	15-5/8"	3"	
<b>5 DRAWERS</b>	29-5/8"	15-5/8"	3"	
<b>2 SHELVES</b>				

Maximum Load per Drawer 100 lb with single slides

\* 200 lb with dual slides





842281



842286

## OPEN FRONT TOOL CHESTS

- Open front design keeps tools organized and visible at a glance, reducing time wasted looking for tools
- All tools are held securely in place when lid is closed – ideal for use on service trucks or atop a roller cabinet or tool cart
- Extra heavy duty 16 gauge steel with fully welded seams for maximum strength
- No drawer slides to fail during transport even over the roughest roads
- Full weather stripping keeps tools dry and clean in outdoor environments
- Dedicated pegs and holes hold a wide variety of sockets, wrenches, extensions, and screwdrivers
- Additional storage compartments hold other miscellaneous tools
- Socket tray lifts to access tools stored underneath
- Strong two point lock with double sided key for security and convenience
- Gas shock raises lid
- Sturdy side handles for easy movement
- Powder coated for corrosion resistance
- Complete with compartment liners
- **TOOLS NOT INCLUDED**

### 26" - Super Heavy Duty

842281 / JOFC-26

	Width	Depth	Height	Overall Weight
<b>OVERALL</b>	26-1/4"	17-3/8"	18-3/8"	66 lb

Peg Qty. for 1/4" Dr Socket: **18**Peg Qty. for 1/4" Dr Deep Socket: **18**Peg Qty. for 3/8" Dr Socket: **13**Peg Qty. for 3/8" Dr Deep Socket: **13**Peg Qty. for 1/2" Dr Socket: **16**Peg Qty. for 1/2" Dr Deep Socket: **16**Peg Qty. for Wrenches: **17** (up to 3 per peg)

### 36" - Super Heavy Duty

842286 / JOFC-36

	Width	Depth	Height	Overall Weight
<b>OVERALL</b>	30-3/4"	15-1/4"	18-1/4"	66 lb

Peg Qty. for 1/4" Dr Socket: **32**Peg Qty. for 1/4" Dr Deep Socket: **32**Peg Qty. for 3/8" Dr Socket: **28**Peg Qty. for 3/8" Dr Deep Socket: **28**Peg Qty. for 1/2" Dr Socket: **39**Peg Qty. for 1/2" Dr Deep Socket: **40**Peg Qty. for Wrenches: **39** (up to 3 per peg)







## SERVICE CARTS

### 4 Drawer Service Cart 30" x 16" - Heavy Duty

842911 / JTC-30164

- Heavy gauge steel shell for professional use
- Ball bearing slides rated for 75 lb/pair
- 4 drawers, large bottom shelf, and generous under-lid room provide ample storage
- Side tray folds out to provide workspace
- Separate locking screwdriver rack
- Rear drawer lock mechanism for added security
- Lid lays flat against back of cart
- 4 way swivel polyurethane casters
- Comfortable tube steel handle
- Complete with drawer liners



842911

	Width	Depth	Height	Overall Weight
<b>OVERALL</b>	35"	17"	32-3/4"	106 lb
<b>2 DRAWERS</b>	12-3/8"	14-1/2"	2"	
<b>1 DRAWER</b>	26-1/2"	14-1/2"	2"	
<b>1 DRAWER</b>	26-1/2"	14-1/2"	3-1/4"	
<b>SHELF</b>	30"	16"	3"	
<b>UNDER LID</b>	30"	16"	3"	
<b>SIDE SHELF</b>	14"	16"	1/2"	



BALL BEARING SLIDES

### 4 Drawer Service Cart 30" x 19" - Heavy Duty

842916 / JTC-30194

- Heavy gauge steel shell for professional use
- Ball bearing slides rated for 75 lb/pair
- 4 drawers, large bottom shelf, and generous under-lid room provide ample storage
- Drawer slides feature positive retainer system to prevent drawers opening while moving cart
- Long tool storage racks on both sides of cart are secured when lid is locked
- Full height plastic corner bumpers protect automobile finishes from scratches
- Automatic rear drawer lock mechanism engages when lid is closed
- Gas shocks automatically raise lid to open position and unlock all drawers
- 2 fixed and 2 swivel casters with chrome racing style wheels
- Comfortable TPR wrapped oval tube steel handle
- Complete with drawer liners



842916

	Width	Depth	Height	Overall Weight
<b>OVERALL</b>	35"	20-1/2"	40-1/2"	121 lb
<b>2 DRAWERS</b>	12-3/8"	14-1/2"	2"	
<b>1 DRAWER</b>	25-1/2"	17-1/2"	3"	
<b>1 DRAWER</b>	25-1/2"	17-1/2"	6-1/4"	
<b>SHELF</b>	30"	19"	3"	
<b>UNDER LID</b>	30"	19"	6"	



BALL BEARING SLIDES

### 4 Drawer Service Cart 33" x 18" - Heavy Duty

842921 / JTC-33184

- Heavy gauge steel shell for professional use
- Ball bearing slides rated for 50 lb/pair
- 4 drawers, large bottom shelf, and generous under-lid room provide ample storage
- Drawer slides feature positive retainer system to prevent drawers opening while moving cart
- Long tool storage racks on both sides of cart
- Rear drawer lock mechanism for added security
- Gas shocks support lid in open position
- Shocks can be disconnected allowing lid to lay flat against back of cart
- Stiffener plate strengthens lid and prevents warping
- 4 way swivel casters for maximum maneuverability
- Comfortable oval tube steel handle
- Complete with drawer liners

	Width	Depth	Height	Overall Weight
<b>OVERALL</b>	36-1/4"	18"	39-1/4"	93 lb
<b>2 DRAWERS</b>	13-1/2"	15-1/2"	2-1/4"	
<b>1 DRAWER</b>	28-1/4"	15-1/2"	2-1/4"	
<b>1 DRAWER</b>	28-1/4"	15-1/2"	3-1/4"	
<b>SHELF</b>	32-1/4"	17-1/2"	3"	
<b>UNDER LID</b>	32-1/4"	17-1/2"	5"	



### 4 Drawer Service Cart 37" x 20" - Super Heavy Duty

842926 / JTC-37204

- Extra heavy gauge steel shell for professional use
- Ball bearing slides rated for 100 lb/pair
- 4 drawers, large bottom shelf, and generous under-lid room provide ample storage
- Raise and Release drawer retainer system prevents drawers opening while moving cart
- Long tool storage racks on both sides of cart are secured when lid is locked
- Rear drawer lock mechanism for added security
- Gas shocks support lid in open position
- Shocks can be disconnected allowing lid to lay flat against back of cart
- Stiffener plate strengthens lid and prevents warping
- 4 way swivel polyurethane casters with chrome wheels for maximum maneuverability and smooth rolling
- Comfortable tube steel handle
- Complete with drawer liners

	Width	Depth	Height	Overall Weight
<b>OVERALL</b>	40-1/2"	21-1/8"	40-1/2"	166 lb
<b>2 DRAWERS</b>	15"	17"	3"	
<b>1 DRAWER</b>	32-1/4"	17"	3"	
<b>1 DRAWER</b>	32-1/4"	17"	5"	
<b>SHELF</b>	36-1/2"	19-1/2"	3"	
<b>UNDER LID</b>	36-1/2"	19-1/2"	6"	







## SHOP CARTS

- Ideal for garage, office and warehouse applications
- Transport tools around the shop and add much needed workspace
- Heavy gauge steel with enamel finish
- 4 swivel casters (2 free and 2 locking)

### 2 Shelf Shop Cart - Heavy Duty

PROD. NO.	MOD. NO.	Width	Depth	Height	Shipping Weight
842902	JSC-232	32"	17"	36"	38.5 lb (17 kg)



### 3 Shelf Shop Cart - Heavy Duty

PROD. NO.	MOD. NO.	Width	Depth	Height	Shipping Weight
842907	JSC-332	30"	16"	36"	38.5 lb (17 kg)



### Polypropylene Shop Cart - Heavy Duty

- Heavy duty Polypropylene construction supports up to 500 lb
- Two large 36" x 24" trays with 3" lip keeps items securely on board
- Convenient organizer tray moulded into handle
- Will not dent, rust, chip, or peel
- Resists oil and many chemicals
- 5" x 1" non-marking casters
- Quiet rolling cart is ideal for office use

PROD. NO.	MOD. NO.	Width	Depth	Height	Product Weight
842909	JPTC-3624	46"	25-1/2"	33-1/4"	51 lb (23kg)

### 3 Shelf Workbench - Heavy Duty

- Top shelf holds up to 1,750 lb
- Lower shelves hold up to 550 lb each
- 2" wall around sides and back
- Rolled edges for added strength and rigidity
- Electrostatic oven baked powder coat paint finish
- Top - 3mm rolled edge, shelves - 2mm rolled edge

PROD. NO.	MOD. NO.	Width	Depth	Height	Shelves
843002	JWB-7925	79"	25"	34-1/2"	3

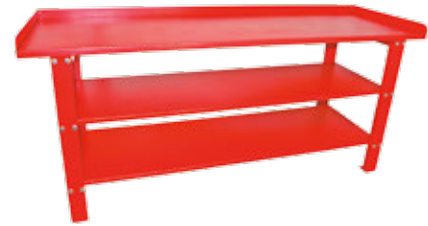

### 2 Drawer Workbench - Heavy Duty

- Top shelf holds up to 1,750 lb
- Lower shelf holds up to 550 lb
- Drawers holds up to 85 lb each
- Full extension ball bearing drawer slides
- 2" wall around sides and back
- Rolled edges for added strength and rigidity
- Electrostatic over baked powder coat paint finish
- Top - 3mm rolled edge, shelf - 2mm rolled edge

PROD. NO.	MOD. NO.	Width	Depth	Height	Shelves
843003	JWB-5925	59"	25"	34-1/2"	2



### Tear Down Table/Workbench - Heavy Duty

- Fluids drain through table top into a removable plastic container (included)
- Comes with locking storage drawer on ball bearing slides
- Multiple shelf locations gives added versatility
- Square tube leg design gives added strength and stability to table top
- Large 4" heavy duty swivel casters (2 locking)
- Table top features 1/2" rim
- Extra heavy duty construction
- Capacity: 1,000 lb

PROD. NO.	MOD. NO.	Width	Depth	Height	Shelves
843012	JTTD-1000	47"	31-1/2"	39-3/4"	2



## TOOL ORGANIZERS

- Aluminum rails with engineered nylon pegs, hooks, and clamps for professional use
- Keeps work space organized for maximum efficiency
- All components resistant to rust, corrosion, and most shop chemicals
- Tool holders can be moved to provide adequate spacing between tools
- Unbreakable in normal use
- Mounting hardware included

### Socket Organizers

PROD. NO.	MOD. NO.	Total Pegs	Socket Drive
841011	JWSR-1414	14	1/4"
841021	JWSR-3814	14	3/8"
841031	JWSR-1214	14	1/2"



841011



841021



841031

### 1/4, 3/8, 1/2" Drive Socket Organizer

- Unique socket pegs can be rotated 360° to keep size markings in view
- Spring ball locks sockets onto pegs for use as portable rack or drawer organizer

PROD. NO.	MOD. NO.	Total Pegs	Socket Drive
841151	JTSR-344	44	16 x 1/4", 14 x 3/8", 14 x 1/2"



\*Tools not included

www.surewerx.com



- Aluminum rails with engineered nylon pegs, hooks, and clamps for professional use
- Keeps work space organized for maximum efficiency
- All components resistant to rust, corrosion, and most shop chemicals
- Tool holders can be moved to provide adequate spacing between tools
- Unbreakable in normal use
- Mounting hardware included

### Combination Wrench Organizer

PROD. NO.	MOD. NO.	Total Pegs
841051	JWWR-1200	12



### Screwdriver Organizer

PROD. NO.	MOD. NO.	Total Pegs
841056	JWSDR-1200	12



### Tool Organizer

- Lock knobs keep tool clamps in place allowing customization of rack for many types of tools

PROD. NO.	MOD. NO.	Total Pegs
841061	JWTR-600	6



\*Tools not included

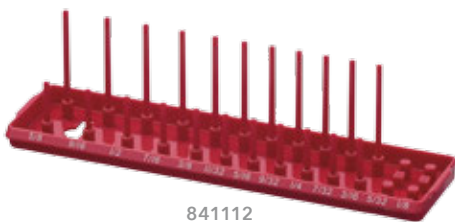

841112



841113

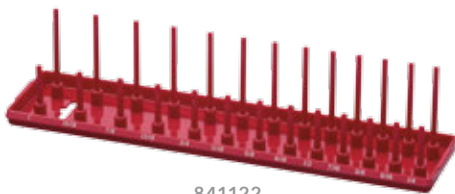

841122

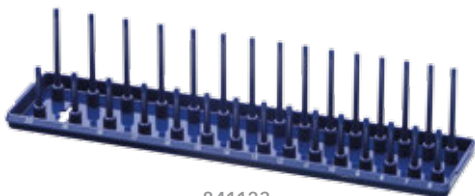

841123

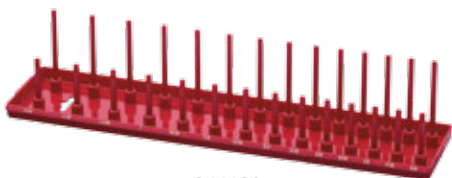

841132



841133

## TOOL ORGANIZERS

### Socket Organizer Trays

- High impact ABS socket trays resist oil and grease
- Sizes marked at top of posts for quick and easy identification
- Trays hold one shallow and one deep socket of each size
- Coloured red for SAE sockets and blue for metric sockets
- Ideal for bench top use
- Fits most brands of sockets

PROD. NO.	MOD. NO.	Description	No. of Pegs	Sizes
841112	JST-1426S	1/4" Drive SAE	26	1/8, 5/32, 3/16, 7/32, 1/4, 9/32, 5/16, 11/32, 3/8, 7/16, 1/2, 9/16, 5/8"
841113	JST-1428M	1/4" Drive Metric	28	4, 4.5, 5, 5.5, 6, 7, 8, 9, 10, 11, 12, 13, 14, 15 mm
841122	JST-3826S	3/8" Drive SAE	26	1/4, 5/16, 3/8, 7/16, 1/2, 9/16, 5/8, 11/16, 3/4, 13/16, 7/8, 15/16, 1"
841123	JST-3830M	3/8" Drive Metric	30	6, 7, 8, 9, 10, 11, 12, 13, 14, 15, 16, 17, 18, 19, 20 mm
841132	JST-1228S	1/2" Drive SAE	28	3/8, 7/16, 1/2, 9/16, 5/8, 11/16, 3/4, 13/16, 7/8, 15/16, 1, 1-1/16, 1-1/8, 1-1/4"
841133	JST-1234M	1/2" Drive Metric	34	10, 11, 12, 13, 14, 15, 16, 17, 18, 19, 20, 21, 22, 23, 24, 25, 27 mm

**NEW**





# RATCHET WRENCHES







670926 - 672927

Includes bonus MHR-3860 (671941)  
3/8" drive mini head ratchet



690106



670929 - 672929

## 1/4", 3/8" & 1/2" DRIVE

### RHQ Series Oval Head

- All components are forged from superior quality Chrome Vanadium steel
- New increased tooth configurations offer finer ratcheting mechanisms
- Available in regular and extra long models
- Push button quick release feature holds sockets on securely until ready to release
- Convenient reversing switch can be operated with one hand
- Comfortable handle style
- Mirror polish finish
- Repair kits available
- All ratchets are designed for use by professionals
- Meets or exceeds ANSI specifications

PROD. NO.	MOD. NO.	Drive	Length (overall)	Teeth	Quick Release
670926	RHQ-14	1/4"	5-1/2"	48	Yes
670928	RHQ-14L	1/4"	7"	48	Yes
671926	RHQ-38	3/8"	8"	48	Yes
671945	RHQ-38L	3/8"	11-3/4"	48	Yes
672926	RHQ-12	1/2"	10"	48	Yes
672927	RHQ-12L	1/2"	15"	48	Yes



### 3 PC RHQ Series Set

- Contains one each of 1/4, 3/8 and 1/2" RHQ ratchets
- **Includes bonus MHR-3860 (671941) 3/8" drive mini head ratchet!**

PROD. NO.	MOD. NO.	Drive	Pieces	Teeth	Quick Release
690106	RHQ-3SB	1/4, 3/8, 1/2"	3	48/60	Yes



### RHQ-F Series Oval Head - Heavy Duty

- Flex head feature allows access into awkward locations
- Same quality features as our RHQ series

PROD. NO.	MOD. NO.	Drive	Length (overall)	Teeth	Quick Release
670929	RHQ-14F	1/4"	6-1/4"	48	Yes
671942	RHQ-38FS	3/8"	4-1/2"	48	Yes
671943	RHQ-38F2	3/8"	11-1/2"	48	Yes
672929	RHQ-12F	1/2"	17-1/2"	48	Yes

Replacement repair kits listed at the back of the Hand Tools section

## HT72 Series High Torque

- All metal components are forged from superior quality Chrome Vanadium steel
- High torque 72 tooth twin pawl ratcheting system exceeds ANSI standards for torque
- 5° maximum movement between each engagement of teeth
- Push button quick release feature holds sockets on securely until ready to release
- Comfortable ergonomic handle design with anti-slip strips improves gripping power and reduces operator fatigue
- Spinner ring for use in areas with restricted space
- Convenient hanging hole
- Patented offset ratchet handle offers unique safety features - reduces knuckle damage and improves socket positioning
- Repair kits available

PROD. NO.	MOD. NO.	Drive	Length (overall)	Teeth	Quick Release
670927	HT-1472	1/4"	5-1/2"	72	Yes
671928	HT-3872	3/8"	7-3/4"	72	Yes
672928	HT-1272	1/2"	10"	72	Yes



671928

## 3 PC HT72 Series Set

690104 / HT-72S

- Contains 1 each: 1/4, 3/8 and 1/2" ratchets above



Super strong twin pawl ratcheting system

Replacement repair kits listed at the back of the Hand Tools section



Push through anvil to reverse direction

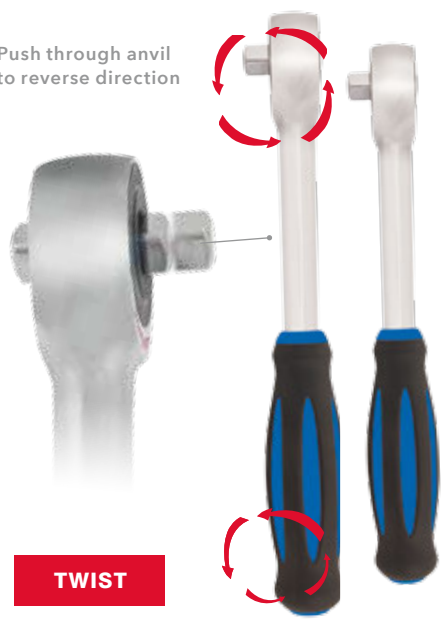

**TWIST**

671923



670922

671922

672922



890512

## 1/4", 3/8" & 1/2" DRIVE

### Twist Drive Ratchets

- Patented Twist Drive action drives sockets without swinging handle - 0° swing arc!
- Special design drives socket in one direction while twisting handle in both directions
- Allows for super fast running of fasteners when space is limited
- Works like a regular ratchet for additional torque
- Co-moulded handle materials provide all day comfort and non-slip grip
- Chrome Vanadium steel handle with Chrome Molybdenum drive gears for maximum strength
- Available in 6 piece POP display

PROD. NO.	MOD. NO.	Drive	Length (overall)	Teeth
671923	TD-3860	<b>3/8"</b>	9-1/4"	60
672923	TD-1260	<b>1/2"</b>	11-1/2"	60



### 270° Swivel Head Ratchets

- Unique 270° rotating head provides ultimate flex head function
- Only the head rotates, providing maximum flex positions while maintaining smallest profile
- 72 tooth quick release ratchet head requires only 5° swing room
- Convenient direction switch on head is accessible from any angle
- Chrome Vanadium steel handle with Chrome Molybdenum drive gears
- Co-moulded handle grip provides all day comfort and sure grip
- Available in 9 piece POP display (3 of each drive size) - **890512**

PROD. NO.	MOD. NO.	Drive	Length (overall)	Teeth	Quick Release
670922	SH270-14	<b>1/4"</b>	5-7/8"	72	Yes
671922	SH270-38	<b>3/8"</b>	9-1/4"	72	Yes
672922	SH270-12	<b>1/2"</b>	11-7/8"	72	Yes

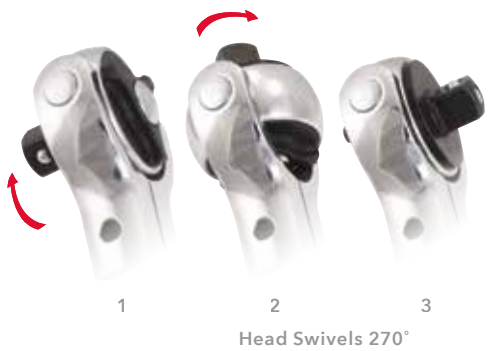

Head Swivels 270°

Replacement repair kits listed at the back of the Hand Tools section

# 1/4", 3/8" & 1/2" DRIVE

## Special Purpose Ratchets



### Mini Head Ratchet Wrench

- Mini head and ultra slim body design allows access into confined areas
- Smooth, 60 tooth ratcheting action offers an extremely small swing area - 6°
- Push button quick release
- Full polish, mirror finish

PROD. NO.	MOD. NO.	Drive	Length (overall)	Teeth	Quick Release
671941	MHR-3860	3/8"	7-3/4"	60	Yes

### Articulating Head Ratchet Wrench

- 3/8" drive ratchet head rotates around articulating joint, providing up to 8x the speed of a regular ratchet
- Rotating head can be locked in any position to clear obstacles and provide maximum access
- 6140 Chrome Vanadium steel for professional use
- Mirror polished finish
- Meets ANSI torque rating for 3/8" drive ratchets

PROD. NO.	MOD. NO.	Drive	Length (overall)	Teeth	Quick Release
671944	HSR-3800	3/8"	10-1/4"	48	Yes



### 4 PC Ratchet Wrench Adapter Set

701196 / RWAS-4

- 1/4", 3/8", and 1/2" socket adapters and 1/4" hex bit adapter provide maximum versatility by turning your ratcheting wrench set into a full wrench, bit, and socket drive set
  - Converts the wrench into an extremely low profile ratchet for access to the most limited spaces
  - Works with flat, reversing, and flex head ratcheting combination wrenches
  - Requires 3/8", 1/2", and 3/4" ratcheting wrenches (sold separately)
  - Available in 4 pc set only
- Contents:
- 1/4" hex bit adapter for use with 3/8" ratcheting wrench
  - 1/4" drive socket adapter for use with 3/8" ratcheting wrench
  - 3/8" drive socket adapter for use with 1/2" ratcheting wrench
  - 1/2" drive socket adapter for use with 3/4" ratcheting wrench
  - Ratchet wrenches sold separately



Replacement repair kits listed at the back of the Hand Tools section



Mini Head



Articulating Joint

Push Button Quick Release

671941

671944



Adapter set converts ratcheting combination wrenches to socket or bit drivers

Socket adapters complete with quick release feature







## 1/4", 3/8" & 1/2" DRIVE

### Ratcheting Adapters

- 3 way ratcheting adapters turn any suitably sized flex bar, sliding T-Bar, or extension bar into a reversible ratchet
- Square drive hole plus round through hole allows use with most drive tools
- Can also be used as a finger ratchet
- Chrome Vanadium steel with Chrome Molybdenum drive anvil for maximum strength
- 52 teeth requires just 7° swing arc for use in very close quarters
- Blow mould case

### 3 Piece Set

PROD. NO.	MOD. NO.	Drive	Pieces
690107	RA352	1/4", 3/8", 1/2"	3

### Open Stock

PROD. NO.	MOD. NO.	Drive	Pieces
670921	RA1452	1/4"	Open Stock
671921	RA3852	3/8"	Open Stock
672921	RA1252	1/2"	Open Stock

CrMo CrV

**JET ratcheting adapters provide the most versatile system for all your ratcheting needs.**



These adapters can be used with:  
1. All lengths of flex bars



2. Sliding T-Bars



3. Socket Extensions



Replacement repair kits listed at the back of the Hand Tools section

## RH Series

- ANSI rated
- Repair kits available
- Professional quality at an economical price

PROD. NO.	MOD. NO.	Drive	Length (overall)	Teeth	Quick Release
673901	RH-75	3/4"	20"	42	No
674901	RH-100	1"	26"	24	No

## RHQ Series Oval Head - Heavy Duty

PROD. NO.	MOD. NO.	Drive	Length (overall)	Teeth	Quick Release
673922	RHQ-34	3/4"	19-1/2"	24	Yes



## HT72 Series High Torque - Heavy Duty

- 72 teeth require just 5° swing room to engage next tooth
- Ideal for fasteners in restricted areas
- Extra heavy pawl spring keeps 8 teeth engaged at all times for maximum strength
- Quick release feature locks accessories to ratchet
- One piece drop forged head and handle

PROD. NO.	MOD. NO.	Drive	Length (overall)	Teeth	Quick Release
673924	HT-3472	3/4"	20"	72	Yes

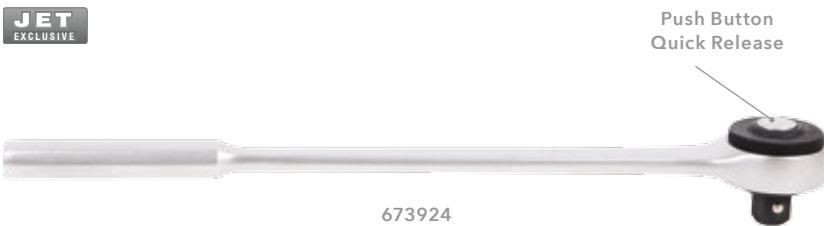

## 7 PC Telescope Tool Set

690105 / SDK3407

### STANDARD ACCESSORIES:

- 40 tooth super duty reversible ratchet (673923)
- 20-32" telescoping drive handle (for use with all items in kit) (673914)
- 4" extension (673903)
- 3/4" Female x 1" Male adapter (673912)
- Sliding T-handle head (673910)
- Flex joint head (673911)
- Blow mould case



Replacement repair kits listed at the back of the Hand Tools section



674906



673923



## 3/4" & 1" DRIVE

### RHD Series - Super Heavy Duty

- All components made from the best quality Chrome Vanadium steel
- Designed to withstand the toughest applications
- Handles sold separately

### Heads

PROD. NO.	MOD. NO.	Drive	Teeth	Quick Release
673923	RHD3400	3/4"	40	No
674906	RHD1036	1"	36	No

CrV

### Handles

PROD. NO.	MOD. NO.	Length (Overall)
673913	DH3400	20" for 673923 (RHD3400), 673910 (SA7509), 673911 (SA7510)
673914	TDH3400	20" - 32" for 673923 (RHD3400), 673910 (SA7509), 673911 (SA7510)
674907	DH1036	25" for 677906 (RHD1036)

CrV

For 3/4" heads



673913

20 - 32"



673914

For 1" heads



674907

Replacement repair kits listed at the back of the Hand Tools section





# CHROME SOCKETS







# TORQUE DRIVE



## 1/4" DR SOCKET WRENCH SETS

- All components forged from high quality Chrome Vanadium steel
- TORQUE DRIVE® sockets contact the fastener on the sides rather than the corners, reducing corner rounding and allowing 20% more torque
- Chamfered edges allow easiest socket placement on fastener, increasing productivity and reducing frustration
- Extra long deep sockets ensure maximum accessibility
- Meets or exceeds U.S. Federal Specs: GGG-W-641E and Canadian Government Specs: CDA39-GP-12b and ANSI specifications

### 24 PC SAE - 6 Point

600115 / SW1424-6

STANDARD LENGTH SAE

**3/16, 7/32, 1/4, 9/32, 5/16, 11/32, 3/8, 7/16, 1/2"**

DEEP LENGTH SAE

**3/16, 7/32, 1/4, 9/32, 5/16, 11/32, 3/8, 7/16, 1/2"**

STANDARD ACCESSORIES:

- 48 tooth 5-1/2" quick release oval head ratchet (670926)
- 2" (670904) and 6" (670906) extensions
- 6" spinner handle (670912)
- 1-3/8" universal joint (670908)
- Blow mould case with removable lid

**6 CrV**



### 28 PC Metric - 6 Point

600116 / SW1428M-6

STANDARD LENGTH METRIC

**4, 5, 5.5, 6, 7, 8, 9, 10, 11, 12, 13 mm**

DEEP LENGTH METRIC

**4, 5, 5.5, 6, 7, 8, 9, 10, 11, 12, 13 mm**

STANDARD ACCESSORIES:

- 48 tooth 5-1/2" quick release oval head ratchet (670926)
- 2" (670904) and 6" (670906) extensions
- 6" spinner handle (670912)
- 1-3/8" universal joint (670908)
- Blow mould case with removable lid

**6 CrV**



**⚠ WARNING:** Do not use chrome sockets on impact wrenches

## 42 PC SAE/Metric - 6 Point

600125 / SW1442C-6

STANDARD LENGTH SAE

**3/16, 7/32, 1/4, 9/32, 5/16, 11/32, 3/8, 7/16, 1/2"**

DEEP LENGTH SAE

**3/16, 7/32, 1/4, 9/32, 5/16, 11/32, 3/8, 7/16, 1/2"**

STANDARD LENGTH METRIC

**4, 5, 6, 7, 8, 9, 10, 11, 12 mm**

DEEP LENGTH METRIC

**4, 5, 6, 7, 8, 9, 10, 11, 12 mm**

STANDARD ACCESSORIES:

- 72 tooth high torque ratchet (670927)
- 2" (670904) and 4" (670915) extensions
- 6" spinner handle (670912)
- 1-3/8" universal joint (670908)
- Blow mould case with removable lid



**TORQUE DRIVE**



## 42 PC SAE/Metric - 12 Point

600126 / SW1442C-12

STANDARD LENGTH SAE

**3/16, 7/32, 1/4, 9/32, 5/16, 11/32, 3/8, 7/16, 1/2"**

DEEP LENGTH SAE

**3/16, 7/32, 1/4, 9/32, 5/16, 11/32, 3/8, 7/16, 1/2"**

STANDARD LENGTH METRIC

**4, 5, 6, 7, 8, 9, 10, 11, 12 mm**

DEEP LENGTH METRIC

**4, 5, 6, 7, 8, 9, 10, 11, 12 mm**

STANDARD ACCESSORIES:

- 72 tooth high torque ratchet (670927)
- 2" (670904) and 4" (670915) extensions
- 6" spinner handle (670912)
- 1-3/8" universal joint (670908)
- Blow mould case with removable lid



**WARNING:** Do not use chrome sockets on impact wrenches

**TORQUE DRIVE**

## 3/8" DR SOCKET WRENCH SETS

- All components forged from high quality Chrome Vanadium steel
- TORQUE DRIVE® sockets contact the fastener on the sides rather than the corners, reducing corner rounding and allowing 20% more torque
- Chamfered edges allow easiest socket placement on fastener, increasing productivity and reducing frustration
- Extra long deep sockets ensure maximum accessibility
- Meets or exceeds U.S. Federal Specs: GGG-W-641E and Canadian Government Specs: CDA39-GP-12b and ANSI specifications

### 11 PC SAE - 6 Point

**600223 / SW3811-6**

STANDARD LENGTH SAE

**5/16, 3/8, 7/16, 1/2, 9/16, 5/8, 11/16, 3/4"**

STANDARD ACCESSORIES:

- 48 tooth 8" quick release oval head ratchet (**671926**)
- 6" extension (**671907**)
- Blow mould case

**6 CrV**

### 15 PC Metric - 6 Point

**600226 / SW3815M-6**

STANDARD LENGTH METRIC

**8, 9, 10, 11, 12, 13, 14, 15, 16, 17, 18, 19 mm**

STANDARD ACCESSORIES:

- 48 tooth 8" quick release oval head ratchet (**671926**)
- 6" extension (**671907**)
- Blow mould case

**6 CrV**

### 21 PC SAE - 6 Point

**600229 / SW3821-6**

STANDARD LENGTH SAE

**3/8, 7/16, 1/2, 9/16, 5/8, 11/16, 3/4"**

DEEP LENGTH SAE

**3/8, 7/16, 1/2, 9/16, 5/8, 11/16, 3/4, 13/16"**

STANDARD ACCESSORIES:

- 48 tooth 8" quick release oval head ratchet (**671926**)
- 3" (**671905**) and 6" (**671907**) extensions
- 8" flex handle (**671902**)
- 1-7/8" universal joint (**671910**)
- Blow mould case with removable lid

**6 CrV**

**⚠ WARNING:** Do not use chrome sockets on impact wrenches

## 30 PC Metric - 6 Point

600234 / SW3830M-6

STANDARD LENGTH METRIC

**8, 9, 10, 11, 12, 13, 14, 15, 16, 17, 18, 19 mm**

DEEP LENGTH METRIC

**8, 9, 10, 11, 12, 13, 14, 15, 16, 17, 18, 19 mm**

STANDARD ACCESSORIES:

- 48 tooth 8" quick release oval head ratchet (671926)
- 3" (671905) and 6" (671907) extensions
- 8" flex handle (671902)
- 1-7/8" universal joint (671910)
- Blow mould case with removable lid

**6 CrV**



**TORQUE DRIVE**



## 45 PC SAE/Metric - 6 Point

600241 / SW3845C-6

STANDARD LENGTH SAE

**3/8, 7/16, 1/2, 9/16, 5/8, 11/16, 3/4"**

DEEP LENGTH SAE

**3/8, 7/16, 1/2, 9/16, 5/8, 11/16, 3/4, 13/16"**

STANDARD LENGTH METRIC

**8, 9, 10, 11, 12, 13, 14, 15, 16, 17, 18, 19 mm**

DEEP LENGTH METRIC

**8, 9, 10, 11, 12, 13, 14, 15, 16, 17, 18, 19 mm**

STANDARD ACCESSORIES:

- 72 tooth high torque ratchet (671928)
- 3" (671905) and 6" (671907) extensions
- 8" flex handle (671902)
- 1-7/8" universal joint (671910)
- Blow mould case with removable lid

**6 CrV**



## 45 PC SAE/Metric - 12 Point

600242 / SW3845C-12

STANDARD LENGTH SAE

**3/8, 7/16, 1/2, 9/16, 5/8, 11/16, 3/4"**

DEEP LENGTH SAE

**3/8, 7/16, 1/2, 9/16, 5/8, 11/16, 3/4, 13/16"**

STANDARD LENGTH METRIC

**8, 9, 10, 11, 12, 13, 14, 15, 16, 17, 18, 19 mm**

DEEP LENGTH METRIC

**8, 9, 10, 11, 12, 13, 14, 15, 16, 17, 18, 19 mm**

STANDARD ACCESSORIES:

- 72 tooth high torque ratchet (671928)
- 3" (671905) and 6" (671907) extensions
- 8" flex handle (671902)
- 1-7/8" universal joint (671910)
- Blow mould case with removable lid

**12 CrV**



**WARNING:** Do not use chrome sockets on impact wrenches



# HEAT TREATED FOR PROFESSIONAL USE

## TORQUE DRIVE®

### 1/2" DR SOCKET WRENCH SETS

- All components forged from high quality Chrome Vanadium steel
- TORQUE DRIVE® sockets contact the fastener on the sides rather than the corners, reducing corner rounding and allowing 20% more torque
- Chamfered edges allow easiest socket placement on fastener, increasing productivity and reducing frustration
- Extra long deep sockets ensure maximum accessibility
- Meets or exceeds U.S. Federal Specs: GGG-W-641E and Canadian Government Specs: CDA39-GP-12b and ANSI specifications



#### 19 PC Metric - 6 Point

600326 / SW1219M-6

##### STANDARD LENGTH METRIC

**12, 13, 14, 15, 16, 17, 18, 19, 20, 21, 22, 23, 24 mm**

##### STANDARD ACCESSORIES:

- 48 tooth 10" quick release oval head ratchet (672926)
- 5" (672905) and 10" (672906) extensions
- 15" flex handle (672903)
- 2-3/4" universal joint (672908)
- Blow mould case with removable lid

**6** CrV



#### 20 PC SAE - 6 Point

600323 / SW1220-6

##### STANDARD LENGTH SAE

**7/16, 1/2, 9/16, 5/8, 11/16, 3/4, 13/16, 7/8, 15/16, 1, 1-1/16, 1-1/8, 1-3/16, 1-1/4"**

##### STANDARD ACCESSORIES:

- 48 tooth 10" quick release oval head ratchet (672926)
- 5" (672905) and 10" (672906) extensions
- 15" flex handle (672903)
- 2-3/4" universal joint (672908)
- Blow mould case

**6** CrV



 **WARNING:** Do not use chrome sockets on impact wrenches

# HIGH QUALITY CHROME VANADIUM STEEL

## 1/2" DR SOCKET WRENCH SETS

### 29 PC SAE - 6 Point

600331 / SW1229-6

#### STANDARD LENGTH SAE

**3/8, 7/16, 1/2, 9/16, 5/8, 11/16, 3/4, 13/16, 7/8, 15/16, 1, 1-1/16, 1-1/8, 1-3/16, 1-1/4"**

#### DEEP LENGTH SAE

**7/16, 1/2, 9/16, 5/8, 11/16, 3/4, 7/8"**

#### STANDARD ACCESSORIES:

- 48 tooth 10" quick release oval head ratchet (672926)
- 2" (672904), 5" (672905) and 10" (672906) extensions
- 10" sliding T-handle (672907)
- 2-3/4" universal joint (672908)
- Blow mould case with removable lid

**6 CrV**



## TORQUE DRIVE®



### 55 PC SAE/Metric - 6 Point

600341 / SW1255C-6

#### STANDARD LENGTH SAE

**3/8, 7/16, 1/2, 9/16, 5/8, 11/16, 3/4, 13/16, 7/8, 15/16, 1, 1-1/16, 1-1/8, 1-3/16, 1-1/4"**

#### DEEP LENGTH SAE

**7/16, 1/2, 9/16, 5/8, 11/16, 3/4, 7/8"**

#### STANDARD LENGTH METRIC

**10, 11, 12, 13, 14, 15, 16, 17, 18, 19, 21, 22, 23, 24, 27, 30, 32mm**

#### DEEP LENGTH METRIC

**10, 12, 13, 14, 15, 16, 17, 18, 19, 21 mm**

#### STANDARD ACCESSORIES:

- 72 tooth high torque ratchet (672928)
- 2" (672904), 5" (672905) and 10" (672906) extensions
- 10" sliding T-handle (672907)
- 2-3/4" universal joint (672908)
- Blow mould case with removable lid

**6 CrV**



**⚠ WARNING:** Do not use chrome sockets on impact wrenches



**TORQUE DRIVE**



## 3/4" DR SOCKET WRENCH SETS

- All components forged from high quality Chrome Vanadium steel
- Chamfered edges allow easiest socket placement on fastener, increasing productivity and reducing frustration
- Meets or exceeds U.S. Federal Specs: GGG-W-641E and Canadian Government Specs: CDA39-GP-12b and ANSI specifications

### 7 PC Telescope Tool Set

690105 / SDK3407

#### STANDARD ACCESSORIES:

- 40 tooth super duty reversible ratchet (673923)
- 20-32" telescoping drive handle (for use with all items in kit) (673914)
- 4" extension (673903)
- 3/4" Female x 1" Male adapter (673912)
- Sliding T-handle head (673910)
- Flex joint head (673911)
- Blow mould case

CrV



### 21 PC SAE - 12 Point

600402 / SW7521

#### STANDARD LENGTH SAE

**3/4, 7/8, 15/16, 1, 1-1/16, 1-1/8, 1-3/16, 1-1/4, 1-5/16, 1-3/8, 1-7/16, 1-1/2, 1-5/8, 1-3/4, 1-7/8, 2"**

#### STANDARD ACCESSORIES:

- 42 tooth 20" round head ratchet (673901)
- 4" (673903) and 8" (673904) extensions
- 18" sliding T-handle (673906)
- Metal case

12 CrV



### 21 PC SAE - 12 Point

600406 / SW7521-HD

#### STANDARD LENGTH SAE

**3/4, 7/8, 15/16, 1, 1-1/16, 1-1/8, 1-3/16, 1-1/4, 1-5/16, 1-3/8, 1-7/16, 1-1/2, 1-5/8, 1-3/4, 1-7/8, 2"**

#### STANDARD ACCESSORIES:

- 24 tooth 19-1/2" deluxe oval head ratchet (673922)
- 4" (673903) and 8" (673904) extensions
- 18" sliding T-handle (673906)
- Blow mould case

12 CrV



Heavy Duty Ratchet

**WARNING:** Do not use chrome sockets on impact wrenches



# 1" DR SOCKET WRENCH SETS



- All components forged from high quality Chrome Vanadium steel
- TORQUE DRIVE® sockets contact the fastener on the sides rather than the corners, reducing corner rounding and allowing 20% more torque
- Chamfered edges allow easiest socket placement on fastener, increasing productivity and reducing frustration
- Extra long deep sockets ensure maximum accessibility
- Meets or exceeds U.S. Federal Specs: GGG-W-641E and Canadian Government Specs: CDA39-GP-12b and ANSI specifications



## 17 PC SAE - 12 Point

600505 / SW1017

STANDARD LENGTH SAE

**1-7/16, 1-1/2, 1-5/8, 1-11/16, 1-3/4, 1-7/8, 2, 2-3/16,  
2-1/4, 2-3/8, 2-1/2"**

STANDARD ACCESSORIES:

- 24 tooth heavy duty reversible ratchet head (674901)
- 8" (674905) and 16" (674903) extensions
- 22" universal handle (included with 674901)
- Sliding T-head
- Metal case



## 21 PC SAE - 12 Point

600503 / SW1021

STANDARD LENGTH SAE

**1-7/16, 1-1/2, 1-5/8, 1-11/16, 1-3/4, 1-13/16,  
1-7/8, 2, 2-1/8, 2-3/16, 2-1/4, 2-3/8, 2-1/2, 2-5/8,  
2-3/4, 2-15/16, 3-1/8"**

STANDARD ACCESSORIES:

- 24 tooth heavy duty reversible ratchet head (674901)
- 8" (674905) and 16" (674903) extensions
- 22" universal handle (included with 674901)
- Sliding T-head
- Metal case



**WARNING:** Do not use chrome sockets on impact wrenches



**TORQUE DRIVE**



## 1/4" DR SOCKET SETS

- All components forged from high quality Chrome Vanadium steel
- TORQUE DRIVE® sockets contact the fastener on the sides rather than the corners, reducing corner rounding and allowing 20% more torque
- Chamfered edges allow easiest socket placement on fastener, increasing productivity and reducing frustration
- Extra long deep sockets ensure maximum accessibility
- Meets or exceeds U.S. Federal Specs: GGG-W-641E and Canadian Government Specs: CDA39-GP-12b and ANSI specifications

### 9 PC SAE - 6 Point

601102 / SS1409-6

STANDARD LENGTH SAE

**3/16, 7/32, 1/4, 9/32, 5/16, 11/32, 3/8, 7/16, 1/2"**

- Includes socket rail

**6 CrV**

### 9 PC Deep SAE - 6 Point

601107 / SS1409D-6

DEEP LENGTH SAE

**3/16, 7/32, 1/4, 9/32, 5/16, 11/32, 3/8, 7/16, 1/2"**

- Includes socket rail

**6 CrV**

### 11 PC Metric - 6 Point

601113 / SS1411M-6

STANDARD LENGTH METRIC

**4, 5, 5.5, 6, 7, 8, 9, 10, 11, 12, 13 mm**

- Includes socket rail

**6 CrV**

### 11 PC Deep Metric - 6 Point

601118 / SS1411DM-6

DEEP LENGTH METRIC

**4, 5, 5.5, 6, 7, 8, 9, 10, 11, 12, 13 mm**

- Includes socket rail

**6 CrV**

**⚠ WARNING:** Do not use chrome sockets on impact wrenches

## 3/8" DR SOCKET SETS



- All components forged from high quality Chrome Vanadium steel
- TORQUE DRIVE® sockets contact the fastener on the sides rather than the corners, reducing corner rounding and allowing 20% more torque
- Chamfered edges allow easiest socket placement on fastener, increasing productivity and reducing frustration
- Extra long deep sockets ensure maximum accessibility
- Meets or exceeds U.S. Federal Specs: GGG-W-641E and Canadian Government Specs: CDA39-GP-12b and ANSI specifications

**TORQUE DRIVE**®

### 8 PC SAE - 6 Point

601219 / SS3808-6

STANDARD LENGTH SAE

**5/16, 3/8, 7/16, 1/2, 9/16, 5/8, 11/16, 3/4"**

- Includes socket rail



### 8 PC Deep SAE - 6 Point

601220 / SS3808D-6

DEEP LENGTH SAE

**3/8, 7/16, 1/2, 9/16, 5/8, 11/16, 3/4, 13/16"**

- Includes socket rail



### 9 PC SAE - 12 Point

601227 / SS3809-12

STANDARD LENGTH SAE

**1/4, 5/16, 3/8, 7/16, 1/2, 9/16, 5/8, 11/16, 3/4"**

- Includes socket rail



### 9 PC Deep SAE - 12 Point

601229 / SS3809D-12

DEEP LENGTH SAE

**1/4, 5/16, 3/8, 7/16, 1/2, 9/16, 5/8, 11/16, 3/4"**

- Includes socket rail



**WARNING:** Do not use chrome sockets on impact wrenches



# TORQUE DRIVE®



## 3/8" DR SOCKET SETS

- All components forged from high quality Chrome Vanadium steel
- TORQUE DRIVE® sockets contact the fastener on the sides rather than the corners, reducing corner rounding and allowing 20% more torque
- Chamfered edges allow easiest socket placement on fastener, increasing productivity and reducing frustration
- Extra long deep sockets ensure maximum accessibility
- Meets or exceeds U.S. Federal Specs: GGG-W-641E and Canadian Government Specs: CDA39-GP-12b and ANSI specifications

### 12 PC Metric - 6 Point

601224 / SS3812M-6

STANDARD LENGTH METRIC

**8, 9, 10, 11, 12, 13, 14, 15, 16, 17, 18, 19 mm**

- Includes socket rail

**6** CrV

### 12 PC Metric - 12 Point

601234 / SS3812M-12

STANDARD LENGTH METRIC

**8, 9, 10, 11, 12, 13, 14, 15, 16, 17, 18, 19 mm**

- Includes socket rail

**12** CrV

### 12 PC Deep Metric - 6 Point

601226 / SS3812DM-6

DEEP LENGTH METRIC

**8, 9, 10, 11, 12, 13, 14, 15, 16, 17, 18, 19 mm**

- Includes socket rail

**6** CrV

### 12 PC Deep Metric - 12 Point

601236 / SS3812DM-12

DEEP LENGTH METRIC

**8, 9, 10, 11, 12, 13, 14, 15, 16, 17, 18, 19 mm**

- Includes socket rail

**12** CrV

**⚠ WARNING:** Do not use chrome sockets on impact wrenches



## 1/2" DR SOCKET SETS



- All components forged from high quality Chrome Vanadium steel
- TORQUE DRIVE® sockets contact the fastener on the sides rather than the corners, reducing corner rounding and allowing 20% more torque
- Chamfered edges allow easiest socket placement on fastener, increasing productivity and reducing frustration
- Extra long deep sockets ensure maximum accessibility
- Meets or exceeds U.S. Federal Specs: GGG-W-641E and Canadian Government Specs: CDA39-GP-12b and ANSI specifications

**TORQUE DRIVE**®

### 15 PC SAE - 6 Point

601316 / SS1215-6

STANDARD LENGTH SAE

**3/8, 7/16, 1/2, 9/16, 5/8, 11/16, 3/4, 13/16, 7/8, 15/16, 1, 1-1/16,  
1-1/8, 1-3/16, 1-1/4"**

- Includes socket rail



### 15 PC SAE - 12 Point

601317 / SS1215-12

STANDARD LENGTH SAE

**3/8, 7/16, 1/2, 9/16, 5/8, 11/16, 3/4, 13/16, 7/8, 15/16, 1, 1-1/16,  
1-1/8, 1-3/16, 1-1/4"**

- Includes socket rail



### 13 PC Deep SAE - 6 Point

601313 / SS1213D-6

DEEP LENGTH SAE

**7/16, 1/2, 9/16, 5/8, 11/16, 3/4, 13/16, 7/8, 15/16, 1, 1-1/16, 1-1/8, 1-1/4"**

- Includes socket rail



### 13 PC Deep SAE - 12 Point

601318 / SS1213D-12

DEEP LENGTH SAE

**7/16, 1/2, 9/16, 5/8, 11/16, 3/4, 13/16, 7/8, 15/16, 1, 1-1/16, 1-1/8, 1-1/4"**

- Includes socket rail



**WARNING:** Do not use chrome sockets on impact wrenches

**TORQUE DRIVE** **13 PC Metric - 6 Point**

601312 / SS1213M-6

STANDARD LENGTH METRIC

**10, 12, 13, 14, 15, 16, 17, 18, 19, 20, 21, 22, 24 mm**

- Includes socket rail

**6** CrV**14 PC Metric - 12 Point**

601319 / SS1214M-12

STANDARD LENGTH METRIC

**10, 11, 12, 13, 14, 15, 16, 17, 18, 19, 20, 21, 22, 24 mm**

- Includes socket rail

**12** CrV**13 PC Deep Metric - 6 Point**

601314 / SS1213DM-6

DEEP LENGTH METRIC

**10, 12, 13, 14, 15, 16, 17, 18, 19, 20, 21, 22, 24 mm**

- Includes socket rail

**6** CrV**14 PC Deep Metric - 12 Point**

601320 / SS1214DM-12

DEEP LENGTH METRIC

**10, 11, 12, 13, 14, 15, 16, 17, 18, 19, 20, 21, 22, 24 mm**

- Includes socket rail

**12** CrV

 **WARNING:** Do not use chrome sockets on impact wrenches



## 3/4" DR SOCKET SETS

- All components forged from high quality Chrome Vanadium steel
- TORQUE DRIVE® sockets contact the fastener on the sides rather than the corners, reducing corner rounding and allowing 20% more torque
- Chamfered edges allow easiest socket placement on fastener, increasing productivity and reducing frustration
- Extra long deep sockets ensure maximum accessibility
- Meets or exceeds U.S. Federal Specs: GGG-W-641E and Canadian Government Specs: CDA39-GP-12b and ANSI specifications

### 17 PC SAE - 12 Point

601405 / SS3417

STANDARD LENGTH SAE

**7/8, 15/16, 1, 1-1/16, 1-1/8, 1-3/16, 1-1/4, 1-5/16, 1-3/8, 1-7/16, 1-1/2, 1-5/8, 1-3/4, 1-13/16, 1-7/8, 2"**

- Metal case

**12** CrV

### 17 PC Deep SAE - 6 Point

601407 / SS31417D-6

DEEP LENGTH SAE

**7/8, 15/16, 1, 1-1/16, 1-1/8, 1-3/16, 1-1/4, 1-5/16, 1-3/8, 1-7/16, 1-1/2, 1-5/8, 1-3/4, 1-13/16, 1-7/8, 2"**

- Metal case

**6** CrV

### 17 PC Metric - 12 Point

601406 / SS3417M

STANDARD LENGTH METRIC

**19, 21, 22, 23, 24, 26, 27, 29, 30, 32, 35, 36, 38, 41, 46, 50 mm**

- Metal case

**12** CrV

 **WARNING:** Do not use chrome sockets on impact wrenches

**TORQUE DRIVE**®





## HEX BIT SOCKET SETS

- All sockets forged from high quality Chrome Vanadium steel
- Hex bits are made of superior quality S2 steel for maximum strength
- Meets or exceeds U.S. Federal Specs: GGG-W-641E and Canadian Government Specs: CDA39-GP-12b and ANSI B107-10M, B107-1, B107-5

### 7 PC SAE Hex Bit

601201 / HSW3811



- 3/8" DR  
2" (OVERALL LENGTH) SAE HEX BIT SOCKETS:  
**1/8, 5/32, 3/16, 7/32, 1/4, 5/16, 3/8"**
- Includes socket rail



### 7 PC Metric Hex Bit

601202 / HSW3811M



- 3/8" DR  
2" (OVERALL LENGTH) METRIC HEX BIT SOCKETS:  
**3, 4, 5, 6, 7, 8, 10 mm**
- Includes socket rail



### 10 PC SAE Hex Bit

601802 / HSW3812-10



- 3/8" DR  
2" (OVERALL LENGTH) SAE HEX BIT SOCKETS:  
**1/8, 5/32, 3/16, 7/32, 1/4, 5/16, 3/8"**
- 1/2" DR  
2-1/4" (OVERALL LENGTH) SAE HEX BIT SOCKETS:  
**1/2, 9/16, 5/8"**
- Includes socket rail



### 10 PC Metric Hex Bit

601803 / HSW3812-10M



- 3/8" DR  
2" (OVERALL LENGTH) METRIC HEX BIT SOCKETS:  
**3, 4, 5, 6, 7, 8, 10mm**
- 1/2" DR  
2-1/4" (OVERALL LENGTH) METRIC HEX BIT SOCKETS:  
**12, 14, 16mm**
- Includes socket rail



**⚠ WARNING: Do not use chrome sockets on impact wrenches**



## 7 PC SAE Long Ball Nose

601804 / LHSW3807

- 3/8" DR  
4" (OVERALL LENGTH) S.A.E EXTRA LONG BALL NOSE HEX BIT SOCKETS:  
**1/8, 5/32, 3/16, 7/32, 1/4, 5/16, 3/8"**
- Includes socket rail



## 7 PC Metric Long Ball Nose

601805 / LHSW3807M

- 3/8" DR  
4" (OVERALL LENGTH) METRIC HEX BIT SOCKETS:  
**4, 5, 6, 7, 8, 9, 10 mm**
- Includes socket rail



## 14 PC SAE / Metric - Long Series

601808 / LHSW1438-14C

- 4" (OVERALL LENGTH) SAE EXTRA LONG HEX BIT SOCKETS:
- 1/4" DR:  
**1/8, 5/32, 3/16"**
- 3/8" DR:  
**7/32, 1/4, 5/16, 3/8"**
- 4" (OVERALL LENGTH) METRIC EXTRA LONG HEX BIT SOCKETS:
- 1/4" DR:  
**4, 5, 6mm**
- 3/8" DR:  
**7, 8, 9, 10 mm**
- Blow mould case



**WARNING:** Do not use chrome sockets on impact wrenches



## TORX® BITS SOCKET SETS

- All sockets forged from high quality Chrome Vanadium steel
- TORX® bits are made of superior quality S2 steel for maximum strength
- Meets or exceeds U.S. Federal Specs: GGG-W-641E and Canadian Government Specs: CDA39-GP-12b and ANSI specifications



### 6 PC 3/8" DR - Tamperproof

601216 / SS386TB

2" (OVERALL LENGTH) TORX® BIT SOCKETS:

**T25, T30, T40, T45, T50, T55**

- Includes socket rail



### 10 PC 1/4" & 3/8" DR - Tamperproof

601801 / SS1438-10TB

- 1/4" DR  
1-1/2" (OVERALL LENGTH) TORX® BIT  
**T10, T15, T20, T25, T27, T30**

- 3/8" DR  
2" (OVERALL LENGTH) TORX® BIT  
**T40, T45, T50, T55**

- Includes socket rail



### 11 PC 1/4" & 3/8" DR

601806 / SS1438-11T

- 1/4" DR  
1-1/2" (OVERALL LENGTH) TORX® BIT:  
**T10, T15, T20, T25, T27, T30**
- 3/8" DR 2" (OVERALL LENGTH) TORX® BIT:  
**T40, T45, T47, T50, T55**
- Includes socket rail



**WARNING:** Do not use chrome sockets on impact wrenches

# EXTERNAL TORX® SOCKET SETS



- All components forged from high quality Chrome Vanadium steel
- Chamfered edges

## 7 PC 1/4" DR 601111 / SS1407TS

STANDARD LENGTH EXTERNAL TORX®

**E4, E5, E6, E7, E8, E10, E11**

- Includes socket rail



## 6 PC 3/8" DR 601231 / SS3806TS

STANDARD LENGTH EXTERNAL TORX®

**E6, E8, E10, E12, E14, E16**

- Includes socket rail



## 12 PC 3/8" DR 601232 / SS3812TS

STANDARD LENGTH EXTERNAL TORX®

**E4, E5, E6, E7, E8, E10, E11, E12, E14, E16, E18, E20**

- Includes socket rail



## 9 PC 1/2" DR 601321 / SS1209TS

STANDARD LENGTH EXTERNAL TORX®

**E10, E11, E12, E14, E16, E18, E20, E22, E24**

- Includes socket rail



## 28 PC 1/4", 3/8" and 1/2" DR 601811 / SS328TS

STANDARD LENGTH EXTERNAL TORX®

- 1/4" DR: **E4, E5, E6, E7, E8, E10, E11**
- 3/8" DR: **E4, E5, E6, E7, E8, E10, E11, E12, E14, E16, E18, E20**
- 1/2" DR: **E10, E11, E12, E14, E16, E18, E20, E22, E24**
- Blow mould case



**WARNING:** Do not use chrome sockets on impact wrenches

- All items meet U.S. Federal Specifications: GGG-W-641e, Canadian Government Specification CDA39-GP-12b and ANSI specifications

Drive Size SAE	1/4" Regular 6 pt.	1/4" Deep 6 pt.	1/4" Regular 12 pt.	1/4" Deep 12 pt.	3/8" Regular 6 pt.	3/8" Deep 6 pt.	3/8" Regular 12 pt.	3/8" Deep 12 pt.
3/16"	670106	670306	670206	670406				
7/32"	670107	670307	670207	670407				
1/4"	670108	670308	670208	670408	671108		671208	671408
9/32"	670109	670309	670209	670409				
5/16"	670110	670310	670210	670410	671110		671210	671410
11/32"	670111	670311	670211	670411				
3/8"	670112	670312	670212	670412	671112	671312	671212	671412
7/16"	670114	670314	670214	670414	671114	671314	671214	671414
1/2"	670116	670316	670216	670416	671116	671316	671216	671416
9/16"					671118	671318	671218	671418
5/8"					671120	671320	671220	671420
11/16"					671122	671322	671222	671422
3/4"					671124	671324	671224	671424
13/16"					671126	671326		
7/8"					671128	671328		
15/16"					671130			
1"					671132			

### 3/8" DR SPARK PLUG SOCKETS



#### 5 PC Magnetic Spark Plug Socket Set

H3704 / SS1438-11T

- Long reach magnetic swivel spark plug socket set
- For hex sizes 5/8", 13/16" and 9/16" on Ford Triton® engines
- Made from CrV steel, with a bright hard chrome finish

**Set Includes:**

- 3/8" DR x 9/16" HEX x 2-1/2" (66 mm) Long ..... **H3704-10**
- 3/8" DR x 5/8" HEX x 4" (101.6 mm) Long ..... **H3704-14**
- 3/8" DR x 5/8" HEX x 6" (152.4 mm) Long ..... **H3704-16**
- 3/8" DR x 5/8" HEX x 11" (279.4 mm) Long ..... **H3704-18**
- 3/8" DR x 13/16" HEX x 6" (152.4 mm) Long ..... **H3704-22**



#### Spark Plug Sockets

- Features rubber inserts to protect spark plugs from damage

PROD. NO.	Drive	Hex Size
671932	3/8"	5/8"
671934	3/8"	13/16"

See our Specialty Automotive section for more information



**WARNING:** Do not use chrome sockets on impact wrenches



- All items meet U.S. Federal Specifications: GGG-W-641e, Canadian Government Specification CDA39-GP-12b and ANSI specifications

Drive	1/2"	1/2"	1/2"	1/2"	3/4"	3/4"	1"
Size SAE	Regular 6 pt.	Deep 6 pt.	Regular 12 pt.	Deep 12 pt.	Regular 12pt.	Deep 6 pt.	Regular 12 pt.
3/8"	672112		672212				
7/16"	672114	672314	672214	672414			
1/2"	672116	672316	672216	672416			
9/16"	672118	672318	672218	672418			
5/8"	672120	672320	672220	672420			
11/16"	672122	672322	672222	672422			
3/4"	672124	672324	672224	672424	673212		
13/16"	672126	672326	672226	672426			
7/8"	672128	672328	672228	672428	673214	673414	
15/16"	672130	672330	672230	672430	673215	673415	
1"	672132	672332	672232	672432	673216	673416	
1-1/16"	672134	672334	672234	672434	673217	673417	
1-1/8"	672136	672336	672236	672436	673218	673418	
1-3/16"	672138		672238		673219	673419	
1-1/4"	672140	672340	672240	672440	673220	673420	
1-5/16"					673221	673421	
1-3/8"					673222	673422	
1-7/16"					673223	673423	674223
1-1/2"					673224	673424	674224
1-9/16"					673225		
1-5/8"					673226	673426	674226
1-11/16"					673227		674227
1-3/4"					673228	673428	674228
1-13/16"					673229	673429	674229
1-7/8"					673230	673430	674230
2"					673232	673432	674232
2-1/8"							674234
2-3/16"							674235
2-1/4"							674236
2-3/8"							674238
2-1/2"							674240
2-5/8"							674242
2-3/4"							674244
2-15/16"							674247
3"							674248
3-1/8"							674250



672414



672228



673224

**WARNING:** Do not use chrome sockets on impact wrenches

## METRIC OPEN STOCK

- All items meet U.S. Federal Specifications: GGG-W-641e, Canadian Government Specification CDA39-GP-12b and ANSI specifications

Drive Size Metric	1/4"		1/4"		3/8"		3/8"	
	Regular 6 pt.	Deep 6 pt.	Regular 12 pt.	Deep 12 pt.	Regular 6 pt.	Deep 6 pt.	Regular 12 pt.	Deep 12 pt.
4 mm	670502	670702	670602	670802				
4.5 mm	670503							
5 mm	670504	670704	670604	670804				
5.5 mm	670505	670705						
6 mm	670506	670706	670606	670806	671506			
7 mm	670507	670707	670607	670807	671507			
8 mm	670508	670708	670608	670808	671508	671708	671608	671808
9 mm	670509	670709	670609	670809	671509	671709	671609	671809
10 mm	670510	670710	670610	670810	671510	671710	671610	671810
11 mm	670511	670711	670611	670811	671511	671711	671611	671811
12 mm	670512	670712	670612	670812	671512	671712	671612	671812
13 mm	670513	670713			671513	671713	671613	671813
14 mm					671514	671714	671614	671814
15 mm					671515	671715	671615	671815
16 mm					671516	671716	671616	671816
17 mm					671517	671717	671617	671817
18 mm					671518	671718	671618	671818
19 mm					671519	671719	671619	671819
20 mm					671520			
21 mm					671521	671721		
22 mm					671522			
23 mm								
24 mm					671524			



 **WARNING:** Do not use chrome sockets on impact wrenches

- All items meet U.S. Federal Specifications: GGG-W-641e, Canadian Government Specification CDA39-GP-12b and ANSI specifications

Drive Size Metric	1/2"		1/2"		3/4"	
	Regular 6 pt.	Deep 6 pt.	Regular 12 pt.	Deep 12 pt.	Regular 12 pt.	
8 mm	672508					
9 mm	672509					
10 mm	672510	672710	672610	672810		
11 mm	672511		672611	672811		
12 mm	672512	672712	672612	672812		
13 mm	672513	672713	672613	672813		
14 mm	672514	672714	672614	672814		
15 mm	672515	672715	672615	672815		
16 mm	672516	672716	672616	672816		
17 mm	672517	672717	672617	672817		
18 mm	672518	672718	672618	672818		
19 mm	672519	672719	672619	672819	673619	
20 mm	672520	672720	672620	672820		
21 mm	672521	672721	672621	672821	673621	
22 mm	672522	672722	672622	672822	673622	
23 mm	672523	672723			673623	
24 mm	672524	672724	672624	672824	673624	
26 mm					673626	
27 mm	672527	672727			673627	
29 mm					673629	
30 mm	672530				673630	
32 mm	672532				673632	
35 mm					673635	
36 mm					673636	
38 mm					673638	
41 mm					673641	
46 mm					673646	
50 mm					673650	



672824



672610

### JET-A-SIZER - Fastener Sizing Tool

779901 / JFST-1

- Handy tool quickly and accurately identifies size of nut or bolt head
- Works on 6 point SAE and Metric fasteners
- Eliminates unnecessary trips to the tool box
- Permanently stamped sizes for a lifetime of use
- Integrated keychain hook keeps tool handy
- Measuring range: 5/16 - 1", 8 - 25mm



**WARNING:** Do not use chrome sockets on impact wrenches



## SAE HEX BITS OPEN STOCK

- All sockets forged from high quality Chrome Vanadium steel
- Hex bits are made of superior quality S2 steel for maximum strength
- Meets or exceeds U.S. Federal Specs: GGG-W-641E and Canadian Government Specs: CDA39-GP-12b and ANSI specifications



Long  
677130



Regular  
677210

Drive Size SAE	1/4"	3/8"	3/8"	3/8"	1/2"
	4" Long	Regular	4" Long	4" Long Ball Nose	Regular
1/8"	677021	677204		677224	
5/32"	677022	677205		677225	
3/16"	677023	677206		677226	
7/32"		677207	677127	677227	
1/4"		677208	677128	677228	
9/32"					
5/16"		677210	677130	677230	
11/32"					
3/8"		677212	677132	677232	
1/2"					677316
9/16"					677318
5/8"					677320



**WARNING:** Do not use chrome sockets on impact wrenches

Long Ball Nose





# METRIC HEX BITS OPEN STOCK



- All sockets forged from high quality Chrome Vanadium steel
- Hex bits are made of superior quality S2 steel for maximum strength
- Meets or exceeds U.S. Federal Specs: GGG-W-641E and Canadian Government Specs: CDA39-GP-12b and ANSI specifications

Drive Size Metric	1/4" 4" Long	3/8" Regular	3/8" 4" Long	3/8" 4" Long Ball Nose	1/2" Regular
3 mm		677253			
4 mm	677071	677254		677274	
5 mm	677072	677255		677275	
6 mm	677073	677256		677276	
7 mm		677257	677177	677277	
8 mm		677258	677178	677278	
9 mm			677179	677279	
10 mm		677260	677180	677280	
12 mm					677362
14 mm					677364
16 mm					677366

**NOTE:** 3/8" drive regular length sockets = 2" overall length  
 1/2" drive regular length sockets = 2-1/4" overall length



Long  
677179



Long Ball Nose  
677280



Regular  
677366

**WARNING:** Do not use chrome sockets on impact wrenches



677767  
tamperproof



677787  
Non-tamperproof



677865

## TORX® BITS OPEN STOCK

Drive Size TORX®	1/4" Non- Tamperproof	1/4" Tamperproof	3/8" Non- Tamperproof	3/8" Tamperproof
T10	677726	677706		
T15	677727	677707		
T20	677728	677708		
T25	677729	677709		677759
T27	677730	677710		
T30	677731	677711		677761
T40			677783	677763
T45			677784	677764
T47			677785	
T50			677786	677766
T55			677787	677767



## EXTERNAL TORX® BITS OPEN STOCK

Drive Size External TORX®	1/4" Regular	3/8" Regular	1/2" Regular
E4	677803	677821	
E5	677804	677822	
E6	677805	677823	
E7	677806	677845	
E8	677807	677824	
E10	677809	677825	677851
E11	677810	677847	677852
E12		677826	677853
E14		677827	677855
E16		677828	677857
E18		677830	677859
E20		677832	677861
E22			677863
E24			677865



**WARNING:** Do not use chrome sockets on impact wrenches

- All components are forged from high quality Chrome Vanadium steel
- Meets or exceeds U.S. Federal Specs: GGG-W-641E and Canadian Government Specs: CDA39-GP-12b and ANSI specifications

### Universal Joints

PROD. NO.	MOD. NO.	Drive
670908	SA1407	1/4" x 1/4"
671910	SA3810	3/8" x 3/8"
672908	SA1207	1/2" x 1/2"

CrV

### Socket Adapters

PROD. NO.	MOD. NO.	Male	Female
<b>OPEN STOCK</b>			
670911	SA1410	3/8"	1/4"
671913	SA3813	1/4"	3/8"
671914	SA3814	1/2"	3/8"
672911	SA1210	3/8"	1/2"
672912	SA1211	3/4"	1/2"
673907	SA7506	1/2"	3/4"
673912	SA7511	1/2"	3/4"

### 5 PC CHROME SOCKET ADAPTER SET

690115	SA-5S	3/8"	1/4"
		1/4"	3/8"
		1/2"	3/8"
		3/8"	1/2"
		3/4"	1/2"

CrV

### Socket Clip Rails

- Includes one each for 1/4", 3/8", and 1/2" drive sockets

PROD. NO.	MOD. NO.	Drive	Clips
<b>3 PC SOCKET CLIP RAIL SET</b>			
690111	SCH-3S	1/4, 3/8, 1/2"	16 each (48 Total)

### OPEN STOCK

670913	SCH-14	1/4"	16
671917	SCH-38	3/8"	16
672913	SCH-12	1/2"	16



670908



673912



672911

673907



690115



690111

**WARNING:** Do not use chrome sockets on impact wrenches



Extra strong CrMo gear components for professional use

## SOCKET ACCESSORIES

- All components are forged from high quality Chrome Vanadium steel
- Meets or exceeds U.S. Federal Specs: GGG-W-641E and Canadian Government Specs: CDA39-GP-12b and ANSI specifications

### Flex Bars

PROD. NO.	MOD. NO.	Drive	Length	Max. Torque
670902	SA1401	1/4"	6"	35 ft/lb
671902	SA3801	3/8"	8"	100 ft/lb
672902	SA1201	1/2"	10"	330 ft/lb
672903	SA1202	1/2"	15"	330 ft/lb
672918	SA1213	1/2" *	24"	330 ft/lb
673909	SA7508	3/4" *	24"	750 ft/lb
673911	SA7510	3/4" **	-	750 ft/lb
674909	SA1008	1"	26"	1,850 ft/lb

Replacement repair kits listed in the back of the catalogue

\*672918 and 673909 features heavy duty head design

\*\*673911 comes with head only - requires drive handle

CrV

### Ratcheting Breaker Bars

- Swivel head breaker bar with 24 tooth ratchet action
- Use in neutral position to break fasteners free, then employ ratchet for fast removal of fastener
- Can also be used to apply greater torque than is possible with standard 1/2" drive ratchets
- Chrome Molybdenum and Chrome Vanadium construction for professional use
- Repair kit available (**900289**)

PROD. NO.	MOD. NO.	Drive	Length
672932	JRBB-18	1/2"	18"
672933	JRBB-24	1/2"	24"

CrMo

CrV



**WARNING:** Do not use chrome sockets on impact wrenches



## Speeder Handles

PROD. NO.	MOD. NO.	Drive	Length
671911	SA3811	3/8"	16"
672909	SA1208	1/2"	16-1/2"



## Sliding T-Handles

PROD. NO.	MOD. NO.	Drive	Length
670907	SA1406	1/4"	4-1/4"
671909	SA3809	3/8"	8"
672907	SA1206	1/2"	10"
673906	SA7505	3/4"	18"
673910	SA7509	3/4" *	Head Only
674904	SA1003	1"	22"



\*Requires drive handle (sold separately)

## Spinner Handles

PROD. NO.	MOD. NO.	Drive	Length
670912	SA1411	1/4"	6"

## T-Handle Spinner Wrenches

- Unique aluminum grip with bearings provides super smooth spinner action
- Adjustable grip can be used in 4 depth positions or removed for access to recessed areas
- Pull down locking collar keeps grip at desired location for most stable use
- 12" length reaches deep into engine bays and other confined spaces
- Chrome Vanadium steel for professional use
- Textured PVC coated T-handle for improved user comfort

## 3 PC T-Handle Spinner Wrench Set

- Comes in convenient EVA foam tool box organizer

PROD. NO.	MOD. NO.	Drive	Length	Pieces
690130	JSTH-3S	1/4, 3/8, 1/2"	12"	3

## OPEN STOCK

670930	-	1/4"	12"	1
671930	-	3/8"	12"	1
672930	-	1/2"	12"	1



**WARNING:** Do not use chrome sockets on impact wrenches



671911



673910



670907



670912



Grip adjust to 4 depth positions or can be removed entirely





690120



690121



672914

## SOCKET ACCESSORIES

- All components are forged from high quality Chrome Vanadium steel
- Meets or exceeds U.S. Federal Specs: GGG-W-641E and Canadian Government Specs: CDA39-GP-12b and ANSI specifications

## EXTENSION BARS

PROD. NO.	MOD. NO.	Pieces	Drive	Length
<b>SETS</b>				
690120	SE38-4S	4	3/8"	1-3/4, 3, 6, 10"
690121	SE12-3S	3	1/2"	2, 5, 10"
672914*	SE12-4S	4	1/2"	15, 18, 24, 30" (extra long)
* Not CrV Steel				
<b>OPEN STOCK</b>				
670904	SA1403	-	1/4"	2"
670905	SA1404	-	1/4"	3"
670915	SA1412	-	1/4"	4"
670906	SA1405	-	1/4"	6"
671904	SA1403	-	3/8"	1-3/4"
671905	SA3804	-	3/8"	3"
671907	SA3806	-	3/8"	6"
671908	SA3808	-	3/8"	10"
672904	SA1203	-	1/2"	2"
672905	SA1204	-	1/2"	5"
672906	SA1205	-	1/2"	10"
673903	SA7502	-	3/4"	4"
673904	SA7503	-	3/4"	8"
673905	SA7504	-	3/4"	16"
674903	SA1002	-	1"	16"
674905	SA1004	-	1"	8"

CrV

**WARNING:** Do not use chrome sockets on impact wrenches

## Locking Extension Bars

- Sockets and accessories lock on and cannot be removed until lock ring is retracted
- Keeps everything from ratchet to the socket positively connected, preventing lost pieces
- Especially useful when multiple extensions must be used
- Ideal for use with JET's quick release ratchet handles
- Coloured lock rings help identify drive size - a JET exclusive!
- Highest quality Chrome Vanadium steel for professional use

PROD. NO.	MOD. NO.	Pieces	Drive	Length
<b>SETS</b>				
690124	SE38-3SL	3	3/8"	3, 6, 10"
690125	SE12-3SL	3	1/2"	3, 5, 10"

## OPEN STOCK

671947	SA3804L	-	3/8"	3"
671948	SA3806L	-	3/8"	6"
671949	SA3808L	-	3/8"	10"
672947	SA1203L	-	1/2"	3"
672948	SA1204L	-	1/2"	5"
672949	SA1205L	-	1/2"	10"



690124



690125

**WARNING:** Do not use chrome sockets on impact wrenches



690122



690123

## SOCKET ACCESSORIES

### 2 Way Wobble Extension Bars

- Two position extensions provide regular or wobble drive
- Place socket in first position for wobble drive; allows improved access to hard-to-reach areas
- Push socket down to second position to lock it solidly in place; allows maximum torque
- Each extension replaces two others but doesn't cost twice as much
- Highest quality Chrome Vanadium steel for professional use

PROD. NO.	MOD. NO.	Pieces	Drive	Length
-----------	----------	--------	-------	--------

#### SETS

690122	SE38-4SW	4	3/8"	1-3/4, 3, 6, 10"
690123	SE12-3SW	3	1/2"	2, 5, 10"

#### OPEN STOCK

671951	SA3803W	-	3/8"	1-3/4"
671952	SA3804W	-	3/8"	3"
671953	SA3806W	-	3/8"	6"
671954	SA3808W	-	3/8"	10"
672951	SA1203W	-	1/2"	2"
672952	SA1204W	-	1/2"	5"
672953	SA1205W	-	1/2"	10"

CrV

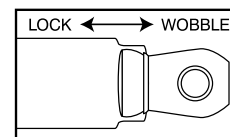

**WARNING:** Do not use chrome sockets on impact wrenches





# IMPACT SOCKETS





## TORQUE DRIVE®



## 3/8" DRIVE SOCKET SETS

- Sockets made of the finest quality SAE 4140 Chrome Molybdenum high impact steel
- TORQUE DRIVE® socket design contacts the fastener on the sides instead of the corners, reducing fastener rounding and allowing up to 20% more torque
- Chamfered edges allow easiest socket placement on fastener, increasing productivity and reducing frustration
- Extra long deep sockets ensure maximum accessibility
- Meets or exceeds U.S. Federal Specs: GGG-W-660A and ANSI specifications

### 8 PC SAE - 6 Point

610201 / PS838

STANDARD LENGTH SAE

5/16, 3/8, 7/16, 1/2, 9/16, 5/8, 11/16, 3/4"

- Blow mould case



### 8 PC Deep SAE - 6 Point

610203 / PS838D

DEEP LENGTH SAE

5/16, 3/8, 7/16, 1/2, 9/16, 5/8, 11/16, 3/4"

- Blow mould case



### 12 PC SAE - 6 Point

610207 / PS1238

STANDARD LENGTH SAE

5/16, 3/8, 7/16, 1/2, 9/16, 5/8, 11/16, 3/4, 13/16, 7/8, 15/16, 1"

- Blow mould case



### 12 PC Deep SAE - 6 Point

610208 / PS1238D

DEEP LENGTH SAE

5/16, 3/8, 7/16, 1/2, 9/16, 5/8, 11/16, 3/4, 13/16, 7/8, 15/16, 1"

- Blow mould case



### 13 PC Metric - 6 Point

610217 / PS1438M

STANDARD LENGTH METRIC

7, 8, 9, 10, 11, 12, 13, 14, 15, 16, 17, 18, 19 mm

- Blow mould case



### 13 PC Deep Metric - 6 Point

610218 / PS1338DM

DEEP LENGTH METRIC

7, 8, 9, 10, 11, 12, 13, 14, 15, 16, 17, 18, 19 mm

- Blow mould case



## 1/2" DRIVE SOCKET SETS



- Sockets made of the finest quality SAE 4140 Chrome Molybdenum high impact steel
- TORQUE DRIVE® socket design contacts the fastener on the sides instead of the corners, reducing fastener rounding and allowing up to 20% more torque
- Chamfered edges allow easiest socket placement on fastener, increasing productivity and reducing frustration
- Extra long deep sockets ensure maximum accessibility
- Meets or exceeds U.S. Federal Specs: GGG-W-660A and ANSI specifications

### 10 PC SAE - 6 Point

610302 / PS1012

STANDARD LENGTH SAE

7/16, 1/2, 9/16, 5/8, 11/16, 3/4, 13/16, 7/8, 15/16, 1"

- Blow mould case



**TORQUE DRIVE**®



### 10 PC Deep SAE - 6 Point

610303 / PS1012D

STANDARD LENGTH SAE

7/16, 1/2, 9/16, 5/8, 11/16, 3/4, 13/16, 7/8, 15/16, 1"

- Blow mould case



### 13 PC SAE - 6 Point

610321 / PS1312

STANDARD LENGTH SAE

7/16, 1/2, 9/16, 5/8, 11/16, 3/4, 13/16, 7/8, 15/16, 1, 1-1/16, 1-1/8, 1-1/4"

- Blow mould case



### 13 PC Deep SAE - 6 Point

610323 / PS1312D

DEEP LENGTH SAE

7/16, 1/2, 9/16, 5/8, 11/16, 3/4, 13/16, 7/8, 15/16, 1, 1-1/16, 1-1/8, 1-1/4"

- Blow mould case



### 19 PC SAE - 6 Point

610328 / PS1912

STANDARD LENGTH SAE

3/8, 7/16, 1/2, 9/16, 5/8, 11/16, 3/4, 13/16, 7/8, 15/16, 1, 1-1/16, 1-1/8, 1-3/16, 1-1/4, 1-5/16, 1-3/8, 1-7/16, 1-1/2"

- Blow mould case with removable lid



### 19 PC Deep SAE - 6 Point

610329 / PS1912D

DEEP LENGTH SAE

3/8, 7/16, 1/2, 9/16, 5/8, 11/16, 3/4, 13/16, 7/8, 15/16, 1, 1-1/16, 1-1/8, 1-3/16, 1-1/4, 1-5/16, 1-3/8, 1-7/16, 1-1/2"

- Blow mould case with removable lid







## TORQUE DRIVE®



Jumbo Sizes



Jumbo Sizes



## 1/2" DRIVE SOCKET SETS

### 8 PC Jumbo SAE - 6 Point

610314 / PS812

STANDARD LENGTH SAE

1-9/16, 1-5/8, 1-11/16, 1-3/4, 1-13/16, 1-7/8, 1-15/16, 2"

- Blow mould case

6 CrMo

### 8 PC Jumbo Deep SAE - 6 Point

610315 / PS812D

DEEP LENGTH SAE

1-9/16, 1-5/8, 1-11/16, 1-3/4, 1-13/16, 1-7/8, 1-15/16, 2"

- Blow mould case with removable lid

6 CrMo

### 12 PC Metric - 6 Point

610308 / PS1212M

STANDARD LENGTH METRIC

10, 12, 13, 14, 15, 16, 17, 18, 19, 21, 22, 24 mm

- Blow mould case

6 CrMo

### 12 PC Deep Metric - 6 Point

610310 / PS1212DM

DEEP LENGTH METRIC

10, 12, 13, 14, 15, 16, 17, 18, 19, 21, 22, 24 mm

- Blow mould case

6 CrMo

## TORQUE DRIVE<sup>®</sup>



### 22 PC Metric - 6 Point

610338 / PS2212M

STANDARD LENGTH METRIC

10, 11, 12, 13, 14, 15, 16, 17, 18, 19, 20, 21, 22, 23, 24, 25,  
26, 27, 28, 29, 30, 32 mm

- Blow mould case with removable lid



### 22 PC Deep Metric - 6 Point

610339 / PS2212DM

DEEP LENGTH METRIC

10, 11, 12, 13, 14, 15, 16, 17, 18, 19, 20, 21, 22, 23, 24, 25,  
26, 27, 28, 29, 30, 32 mm

- Blow mould case with removable lid



### 12 PC Jumbo Metric - 6 Point

610334 / PS1212LM

STANDARD LENGTH METRIC

23, 24, 25, 26, 27, 28, 30, 32, 33, 34, 35, 36 mm

- Blow mould case



Jumbo Sizes



### 12 PC Jumbo Deep Metric - 6 Point

610335 / PS1212DLM

DEEP LENGTH METRIC

23, 24, 25, 26, 27, 28, 30, 32, 33, 34, 35, 36 mm

- Blow mould case with removable lid



Jumbo Sizes



### 22 PC Deep SAE/Metric - 6 Point

610327 / PS2712DC

DEEP LENGTH SAE

7/16, 1/2, 9/16, 5/8, 11/16, 3/4, 13/16, 7/8, 15/16, 1, 1-1/16, 1-1/8, 1-1/4"

DEEP LENGTH METRIC

10, 12, 13, 14, 15, 16, 17, 18, 19, 21, 22, 24 mm

STANDARD ACCESSORIES:

- 5" extension and 1" universal joint
- Blow mould case with removable lid







**TORQUE DRIVE**



610341

**1/2" DRIVE UNIVERSAL SOCKET SETS**

- Made from the best quality SAE 4140 Chrome Molybdenum high impact steel
- Heavy duty flexible joints allow easier access to fasteners in hard to reach areas
- Reinforcement ring ensures maximum strength

**7 PC SAE Universal - 6 Point**

610382 / PSU712

STANDARD LENGTH SAE

1/2, 9/16, 5/8, 11/16, 3/4, 13/16, 7/8"

- Blow mould case



**9 PC Metric Universal - 6 Point**

610388 / PSU912M

STANDARD LENGTH METRIC

13, 14, 15, 16, 17, 18, 19, 21, 22 mm

- Blow mould case



**MAG WHEEL SOCKETS**

- Specially designed for use on high end aluminum and chrome plated wheels
- Premium grade Chrome Molybdenum steel for professional use
- Plastic sleeve and inner cap to prevent scratches

**1/2" DR Deep SAE/Metric Set**

PROD. NO.	MOD. NO.	Drive	Pieces	Sizes
610341	MWPS-512	1/2"	5	13/16", 7/8", 17, 19 (3/4"), 21 mm

- Blow mould case



**1/2" DR Deep - Open Stock**

PROD. NO.	Drive	Sizes	Replacement Sleeve	Replacement Insert
682867	1/2"	17mm	682981	682991
682869	1/2"	19mm	682982	682992
682871	1/2"	21mm	682983	682993
682876	1/2"	13/16"	682985	682995
682878	1/2"	7/8"	682986	682996

- Specially designed Chrome Molybdenum spring steel flexes at preset torque ratings
- Allows accurate application of specific torque to automobile wheel fasteners
- Prevents over-tightening or uneven tightening of lug nuts, a major cause of wheel and brake rotor damage
- 5 extensions cover most passenger and light truck / SUV wheels
- For use with 1/2" drive impact wrenches rated at 250 ft/lb and line pressure of 90 – 110 PSI
- For aluminum and chrome wheels, use with JET's 1/2" drive Mag Wheel Power Sockets

## TORQUE DRIVE®



### 5 PC 1/2" DR Set

PROD. NO.	MOD. NO.	Drive	Pieces	Torque (ft/lb)
682961	JTLE-5S	1/2"	5	65, 80, 100, 120, 140

- Blow mould case with removable lid



### 1/2" DR - Open Stock

PROD. NO.	Drive	Torque (ft/lb)	Length	Colour
682964	1/2"	65	7-3/4"	Yellow
682965	1/2"	80	7-3/4"	Blue
682966	1/2"	100	7-3/4"	Gray
682967	1/2"	120	7-3/4"	White
682968	1/2"	140	7-3/4"	Aqua

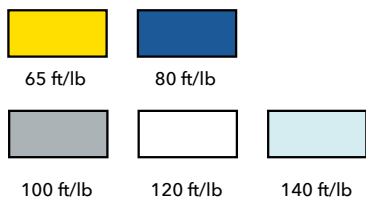



# TORQUE DRIVE®



Jumbo Sizes



## 3/4" DRIVE SOCKET SETS

- Sockets made of the finest quality SAE 4140 Chrome Molybdenum high impact steel
- TORQUE DRIVE® socket design contacts the fastener on the sides instead of the corners, reducing fastener rounding and allowing up to 20% more torque
- Chamfered edges allow easiest socket placement on fastener, increasing productivity and reducing frustration
- Extra long deep sockets ensure maximum accessibility
- Most sets come with two-tone blow mould cases with removable lids for use as an organizer
- Meets or exceeds U.S. Federal Specs: GGG-W-660A and ANSI specifications

### 8 PC SAE - 6 Point

610401 / PS834

STANDARD LENGTH SAE

1, 1-1/16, 1-1/8, 1-1/4, 1-5/16, 1-3/8, 1-7/16, 1-1/2"

- Blow mould case

**6** CrMo

### 8 PC Deep SAE - 6 Point

610402 / PS834D

DEEP LENGTH SAE

1, 1-1/16, 1-1/8, 1-1/4, 1-5/16, 1-3/8, 1-7/16, 1-1/2"

- Blow mould case

**6** CrMo

### 8 PC Jumbo SAE - 6 Point

610404 / PS834L

STANDARD LENGTH SAE

2-1/16, 2-1/8, 2-3/16, 2-1/4, 2-5/16, 2-3/8, 2-7/16, 2-1/2"

- Blow mould case with removable lid

**6** CrMo

### 14 PC Deep SAE - 6 Point

610406 / PS1434D

DEEP LENGTH SAE

3/4, 13/16, 7/8, 15/16, 1, 1-1/16, 1-1/8, 1-3/16, 1-1/4, 1-5/16, 1-3/8, 1-7/16, 1-1/2, 1-5/8"

- Blow mould case with removable lid

**6** CrMo

### 16 PC SAE - 6 Point

610403 / PS1634

STANDARD LENGTH SAE

3/4, 13/16, 7/8, 15/16, 1, 1-1/16, 1-1/8, 1-1/4, 1-5/16, 1-3/8, 1-7/16, 1-1/2, 1-5/8, 1-3/4, 1-7/8, 2"

- Blow mould case with removable lid

**6** CrMo

## 3/4" DRIVE SOCKET SETS



### 17 PC Metric - 6 Point

610407 / PS1734M

STANDARD LENGTH METRIC

19, 21, 22, 23, 24, 26, 27, 29, 30, 32, 33, 35, 36, 38, 41, 46, 50 mm

- Blow mould case with removable lid



### 17 PC Deep Metric - 6 Point

610408 / PS1734DM

DEEP LENGTH METRIC

19, 21, 22, 23, 24, 26, 27, 29, 30, 32, 33, 35, 36, 38, 41, 46, 50 mm

- Blow mould case with removable lid



### 21 PC SAE - 6 Point

610409 / PS2134

STANDARD LENGTH SAE

3/4, 13/16, 7/8, 15/16, 1, 1-1/16, 1-1/8, 1-3/16, 1-1/4, 1-5/16, 1-3/8, 1-7/16, 1-1/2, 1-9/16, 1-5/8, 1-11/16, 1-3/4, 1-13/16, 1-7/8, 1-15/16, 2"

- Blow mould case with removable lid



### 21 PC Deep SAE - 6 Point

610410 / PS2134D

DEEP LENGTH SAE

3/4, 13/16, 7/8, 15/16, 1, 1-1/16, 1-1/8, 1-3/16, 1-1/4, 1-5/16, 1-3/8, 1-7/16, 1-1/2, 1-9/16, 1-5/8, 1-11/16, 1-3/4, 1-13/16, 1-7/8, 1-15/16, 2"

- Blow mould case with removable lid



## 1" DRIVE SOCKET SETS

### 9 PC SAE - 6 Point

610501 / PS901

STANDARD LENGTH SAE

1, 1-1/8, 1-1/4, 1-3/8, 1-1/2, 1-5/8, 1-3/4, 1-7/8, 2"

- Blow mould case with removable lid



## TORQUE DRIVE



### 18 PC SAE - 6 Point

610509 / PS1801

STANDARD LENGTH SAE

3/4, 13/16, 7/8, 15/16, 1, 1-1/16, 1-1/8, 1-3/16, 1-1/4, 1-5/16, 1-3/8, 1-7/16, 1-1/2, 1-5/8, 1-3/4, 1-13/16, 1-7/8, 2"

- Blow mould case with removable lid







## TORQUE DRIVE®



Jumbo Sizes



Jumbo Sizes



## 1" DRIVE SOCKET SETS

- Sockets made of the finest quality SAE 4140 Chrome Molybdenum high impact steel
- TORQUE DRIVE® socket design contacts the fastener on the sides instead of the corners, reducing fastener rounding and allowing up to 20% more torque
- Chamfered edges allow easiest socket placement on fastener, increasing productivity and reducing frustration
- Extra long deep sockets ensure maximum accessibility
- Most sets come with two-tone blow mould case with removable lid for use as an organizer
- Meets or exceeds U.S. Federal Specs: GGG-W-660A and ANSI specifications

### 9 PC Deep SAE - 6 Point

610503 / PS901D

DEEP LENGTH SAE

1, 1-1/8, 1-1/4, 1-3/8, 1-1/2, 1-5/8, 1-3/4, 1-7/8, 2"

- Blow mould case with removable lid

6 CrMo

### 11 PC Jumbo Deep SAE - 6 Point

610504 / PS1101D

DEEP LENGTH SAE

2-1/16, 2-1/8, 2-3/16, 2-1/4, 2-5/16, 2-3/8, 2-7/16, 2-1/2,  
2-9/16, 2-5/8, 2-3/4"

- Blow mould case with removable lid

6 CrMo

### 12 PC Jumbo SAE - 6 Point

610506 / PS1201

STANDARD LENGTH SAE

2-1/8, 2-1/4, 2-3/8, 2-1/2, 2-9/16, 2-5/8, 2-3/4, 2-7/8, 3, 3-1/8,  
3-1/4, 3-1/2"

- Blow mould case with removable lid

6 CrMo

### 16 PC Deep SAE - 6 Point

610508 / PS1601D

DEEP LENGTH SAE

7/8, 15/16, 1, 1-1/16, 1-1/8, 1-3/16, 1-1/4, 1-5/16, 1-3/8, 1-7/16, 1-1/2, 1-5/8,  
1-3/4, 1-13/16, 1-7/8, 2"

- Blow mould case with removable lid

6 CrMo

# 1" DRIVE TRUCK TIRE SOCKET SETS



- Made of highest quality SAE 4140 Chrome Molybdenum steel for maximum strength and durability
- Special sizes designed for use on most truck wheel fasteners

## 11 PC SAE/Metric

- 11 of the most popular SAE and Metric sizes for heavy trucks
- 4 point sockets for inner Budd-style square fasteners
- Special 1-1/2" hex deep socket features controlled depth, preventing contact with inner cap nut
- Deep thin wall sockets designed for use on Dayton style lugnuts where space is limited
- Blow mould case with removable lid

PROD. NO.	MOD. NO.	4 Point Shallow Budd Sockets	6 Point Deep Budd Sockets	6 Point Thin Wall Sockets
610515	TTPS-11SM	17 mm, 21 mm, 13/16"	33 mm, 35 mm, 38 mm, 41 mm, 1-1/2" controlled depth	1-1/16", 1-1/8", -1/4"



610515

# 1" DRIVE TRUCK TIRE - OPEN STOCK

## Budd Wheel Type - 4 Point

- Designed for use on inner budd-style square fasteners

PROD. NO.	Size	Length
684921	13/16"	57 mm
684922	15/16"	57 mm
684971	17mm	57 mm
684975	21mm	57 mm



684922

684622

## Budd Wheel Type - 6 Point

- For use on most import and some domestic trucks
- 1-1/2" hex socket features controlled depth, preventing contact with wheel when removing outer cap nuts

PROD. NO.	Size	Length
684614	33 mm	98 mm
684616	35 mm	98 mm
684619	38 mm	98 mm
684622	41 mm	98 mm
684966	1-1/2" controlled depth	98 mm



684966

## Extra Thin Wall Type - 6 Point Deep

- For use on Dayton-style lugnuts that are deeply recessed and where space is limited
- Extra thin wall sockets are not a warrantable item

PROD. NO.	Size	Length
684943	1-1/16"	108 mm
684944	1-1/8"	108 mm
684946	1-1/4"	108 mm



Extra Thin Wall

684946



## 1/2" DRIVE TORX® BIT SOCKET SETS

- Made of SNCM 8660 tool steel for 20% greater torque and 20% greater torsional resistance than regular Chrome Molybdenum bits
- Manganese Phosphate finish

### 10 PC - TORX®

610326 / PTB1210

3" OVERALL LENGTH TORX®

**T25 ,T27, T30, T40, T45, T50, T55, T60, T70, T80**

- Blow mould case



## 1/2" DRIVE HEX BIT SOCKET SETS

### 8 PC SAE - Hex

610331 / PHB-1208

3" OVERALL LENGTH SAE

**1/4, 5/16, 3/8, 7/16, 1/2, 9/16, 5/8, 3/4"**

- Blow mould case



### 8 PC Metric - Hex

610333 / PHB1208M

3" OVERALL LENGTH METRIC

**6, 7, 8, 10, 12, 14, 17, 19 mm**

- Blow mould case



### 16 PC SAE/Metric - Hex

610340 / PHB-1216C

3" OVERALL LENGTH SAE

**1/4, 5/16, 3/8, 7/16, 1/2, 9/16, 5/8, 3/4"**

3" OVERALL LENGTH METRIC

**6, 7, 8, 10, 12, 14, 17, 19 mm**

- Set contains all popular sizes of hex bit power sockets!
- Blow mould case



## 3/4" DRIVE HEX BIT SOCKET SETS



- Made of SNCM 8660 tool steel for 20% greater torque and 20% greater torsional resistance than regular Chrome Molybdenum bits
- Manganese Phosphate finish

### 5 PC SAE - Hex

610411 / PHB-3405

3" OVERALL LENGTH SAE

5/8, 3/4, 7/8, 1, 1-1/4"

- Blow mould case with removable lid



### 5 PC Metric - Hex

610421 / PHB3405M

3" OVERALL LENGTH METRIC

17, 19, 22, 24, 27 mm

- Blow mould case with removable lid



## 3/8" & 1/2" DRIVE EXTERNAL TORX® SETS

- Sockets made of the finest quality SAE 4140 Chrome Molybdenum high impact steel
- Set features the full range of popular external TORX® sizes
- Convenient blow mould case keeps sockets organized

### 17 PC - External TORX®

610391 / PTS-17C

STANDARD LENGTH E-TORX® POWER SOCKETS:

- 3/8" Drive Sockets: **E5, E6, E7, E8, E10, E12, E14, E16**
- 1/2" Drive Sockets: **E10, E11, E12, E14, E16, E18, E20, E22, E24**
- Blow mould case







## SOCKET ACCESSORIES

- Sockets made of the finest quality SAE 4140 Chrome Molybdenum high impact steel
- Meets or exceeds U.S. Federal Specs: GGG-W-660A and ANSI specifications



610903



610906



682939



682954



681952

### Accessory Kits

- Blow mould case keeps all items organized and handy
- A great addition to any mechanics tool box

PROD. NO.	MOD. NO.	Description	Contains
610903	PSA3812-7	7 PC Impact Accessory Kit	3/8" dr. x 6" extension 3/8" dr. U Joint 3/8" F x 1/2" M adapter 1/2" dr. x 5" extension 1/2" U Joint 1/2" F x 3/8" M adapter 1/2" F x 3/4" M adapter
610906	PSA3401-5	5 PC Impact Accessory Kit	3/4" dr. U Joint 1" dr. U Joint 3/4" F x 1/2" M adapter 3/4" F x 1" M adapter 1" F x 3/4" M adapter



### 1/2" Drive Extra Thin Wall Flip Sockets

- Extra thin walls allows access to all recessed lugnuts where clearance is limited
- Thin wall impact sockets not a warrantable item

PROD. NO.	Length	Size
682938	76mm	3/4 x 13/16" hex
682939	76mm	19 x 21mm hex



### Extension Bars

PROD. NO.	Length	Drive
681953	3"	3/8"
681954	6"	3/8"
682954	5"	1/2"
682955	10"	1/2"
683951	6"	3/4"
683953	10"	3/4"
684951	6"	1"



### Socket Adapters

- Socket adapters do not carry lifetime warranty

PROD. NO.	Drive Female	Drive Male
681952	3/8"	1/2"
682952	1/2"	3/8"
682953	1/2"	3/4"
683952	3/4"	1/2"
683954	3/4"	1"
684952	1"	3/4"



## Pin Free Impact Locking U-Joints

- Patented hex ball and socket design eliminates connecting pin for increased safety
- Ball and socket distributes force evenly for greater torque and longer life
- Eliminates broken connecting pins, the major source of U joint failures
- Drive anvil locks into straight position when flex function is not required
- Can be left on impact wrench and engaged only when needed



PROD. NO.	MOD. NO.	Drive Female & Male
-----------	----------	---------------------

### 3 PIECE SET

610901	PLUJ-3S	1/4, 3/8, 1/2"
--------	---------	----------------

### OPEN STOCK

680915	PLUJ-1414	1/4"
681915	PLUJ-3838	3/8"
682915	PLUJ-1212	1/2"



610901  
3 Piece Set

## Pin Free Impact U-Joints Adapters

- Patented hex ball and socket design eliminates connecting pin for increased safety
- U-Joint adapters do not carry lifetime warranty



PROD. NO.	MOD. NO.	Drive Female	Drive Male
-----------	----------	--------------	------------

### 5 PIECE SET

610902	PLUJ-5S	See Below	
--------	---------	-----------	--

### OPEN STOCK

680918	PLUJ-1438	1/4"	3/8"
681917	PLUJ-3814	3/8"	1/4"
681918	PLUJ-3812	3/8"	1/2"
682917	PLUJ-1238	1/2"	3/8"
682918	PLUJ-1234	1/2"	3/4"



610902  
5 Piece Set

## Universal Joints

PROD. NO.	Drive Female	Drive Male
681911	3/8"	3/8"
682911	1/2"	1/2"
683955	3/4"	3/4"
684955	1"	1"



682911

683955



# SAE OPEN STOCK

- Sockets made of the finest quality SAE 4140 Chrome Molybdenum high impact steel
- Meets or exceeds U.S. Federal Specs: GGG-W-660A and ANSI specifications



Drive	3/4"	1"	1"
Size SAE	Regular 6 pt.	Regular 6 pt.	Deep 6 pt.
2-1/16"	683166	684165	684266
2-1/8"	683168	684166	684268
2-3/16"	683170	684167	684270
2-1/4"	683172	684168	684272
2-5/16"	683174	684169	684274
2-3/8"	683176	684170	684276
2-7/16"	683178	684171	684278
2-1/2"	683180	684172	684280
2-9/16"		684173	684282
2-5/8"		684174	684284
2-11/16"		684175	
2-3/4"		684176	684288
2-13/16"		684177	
2-7/8"		684178	
2-15/16"		684179	
3"		684180	
3-1/8"		684182	
3-1/4"		684184	
3-3/8"		684186	
3-1/2"		684188	
3-5/8"		684190	
3-3/4"		684192	
3-7/8"		684194	
4"		684196	
4-1/8"		684197	
4-1/4"		684198	
4-1/2"		684199	

Drive	3/8"	3/8"	1/2"	1/2"	1/2"	3/4"	3/4"	1"	1"
Size SAE	Regular 6 pt.	Deep 6 pt.	Regular 6 pt.	Deep 6 pt.	Universal Regular 6pt.	Regular 6 pt.	Deep 6 pt.	Regular 6 pt.	Deep 6 pt.
5/16"	681110	681210							
3/8"	681112	681212	682112	682212					
7/16"	681114	681214	682114	682214					
1/2"	681116	681216	682116	682216	682316				
9/16"	681118	681218	682118	682218	682318				
5/8"	681120	681220	682120	682220	682320				
11/16"	681122	681222	682122	682222	682322				
3/4"	681124	681224	682124	682224	682324	683124	683224	684124	
13/16"	681126	681226	682126	682226	682326	683126	683226	684126	
7/8"	681128	681228	682128	682228	682328	683128	683228	684128	684228
15/16"	681130	681230	682130	682230		683130	683230	684130	684230
1"	681132	681232	682132	682232		683132	683232	684132	684232
1-1/16"			682134	682234		683134	683234	684134	684234
1-1/8"			682136	682236		683136	683236	684136	684236
1-3/16"			682138	682238		683138	683238	684138	684238
1-1/4"			682140	682240		683140	683240	684140	684240
1-5/16"			682142	682242		683142	683242	684142	684242
1-3/8"			682144	682244		683144	683244	684144	684244
1-7/16"			682146	682246		683146	683246	684146	684246
1-1/2"			682148	682248		683148	683248	684148	684248
1-9/16"			682150	682250		683150	683250	684150	684250
1-5/8"			682152	682252		683152	683252	684152	684252
1-11/16"			682154	682254		683154	683254	684154	684254
1-3/4"			682156	682256		683156	683256	684156	684256
1-13/16"			682158	682258		683158	683258	684158	684258
1-7/8"			682160	682260		683160	683260	684160	684260
1-15/16"			682162	682262		683162	683262	684162	684262
2"			682164	682264		683164	683264	684164	684264

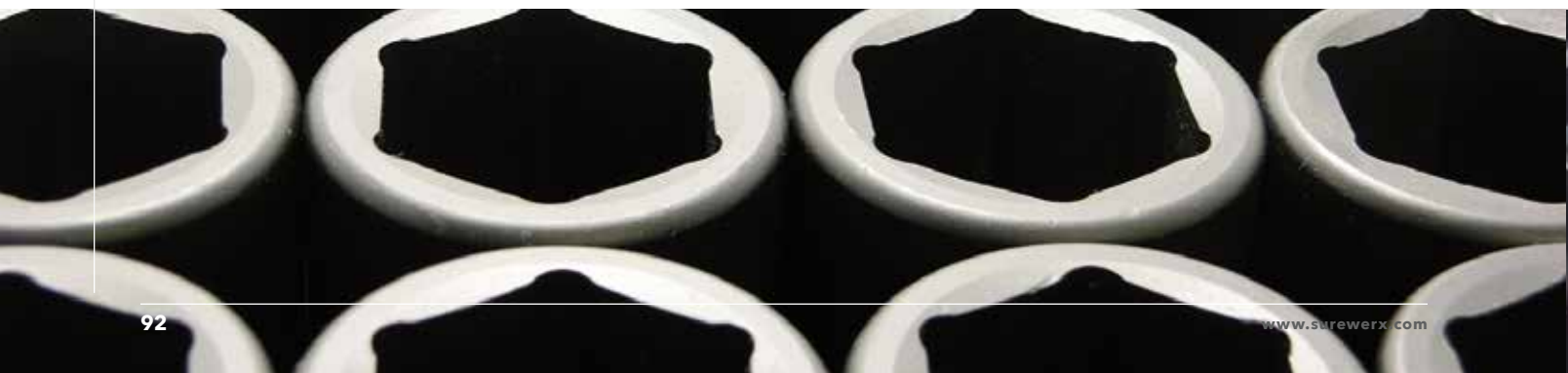

- Sockets made of the finest quality 4140 Chrome Molybdenum high impact steel
- Meets or exceeds U.S. Federal Specs: GGG-W-660A and ANSI specifications

**6** CrMo

Drive	3/8"	3/8"	1/2"	1/2"	1/2"	3/4"	3/4"
Metric (mm)	Regular 6 pt.	Deep 6 pt.	Regular 6 pt.	Deep 6 pt.	Universal Regular 6 pt.	Regular 6 pt.	Deep 6 pt.
7 mm	681507	681607					
8 mm	681508	681608					
9 mm	681509	681609					
10 mm	681510	681610	682510	682610			
11 mm	681511	681611	682511	682611			
12 mm	681512	681612	682512	682612			
13 mm	681513	681613	682513	682613	682713		
14 mm	681514	681614	682514	682614	682714		
15 mm	681515	681615	682515	682615	682715		
16 mm	681516	681616	682516	682616	682716		
17 mm	681517	681617	682517	682617	682717		
18 mm	681518	681618	682518	682618	682718		
19 mm	681519	681619	682519	682619	682719	683519	683619
20 mm			682520	682620			
21 mm			682521	682621	682721	683521	683621
22 mm			682522	682622	682722	683522	683622
23 mm			682523	682623		683523	683623
24 mm			682524	682624		683524	683624
25 mm			682525	682625			
26 mm			682526	682626		683526	683626
27 mm			682527	682627		683527	683627
28 mm			682528	682628			
29 mm			682529	682629		683529	683629
30 mm			682530	682630		683530	683630
32 mm			682532	682632		683532	683632
33 mm			682533	682633		683533	683633
34 mm			682534	682634			
35 mm			682535	682635		683535	683635
36 mm			682536	682636		683536	683636
38 mm						683538	683638
41 mm						683541	683641
46 mm						683546	683646
50 mm						683550	683650





## HEX AND TORX® BITS OPEN STOCK

- Made with premium quality SNCM8660 tool steel for 20% greater torsional resistance than Chrome Molybdenum bits



Drive	1/2"	3/4"
Hex Bits	3" Length Hex Bit	3-1/2" Length Hex Bit
1/4"	687211	
5/16"	687212	
3/8"	687213	
7/16"	687214	
1/2"	687215	
9/16"	687216	
5/8"	687217	687320
3/4"	687219	687324
7/8"		687328
1"		687332
1-1/4"		687340
6mm	687261	
7mm	687262	
8mm	687263	
10mm	687265	
12mm	687267	
14mm	687269	
17mm	687272	687367
19mm	687274	687369
22mm		687372
24mm		687374
27mm		687377

Drive	3/8"	1/2"	1/2"
TORX® Bits	External Torx® Socket	External Torx® Socket	3" Length Torx® Bit
E5	688055		
E6	688056		
E7	688057		
E8	688058		
E10	688060	688110	
E11		688111	
E12	688062	688112	
E14	688064	688114	
E16	688066	688116	
E18		688118	
E20		688120	
E22		688122	
E24		688124	
T25			687821
T27			687822
T30			687823
T40			687825
T45			687826
T50			687827
T55			687828
T60			687829
T70			687831
T80			687833



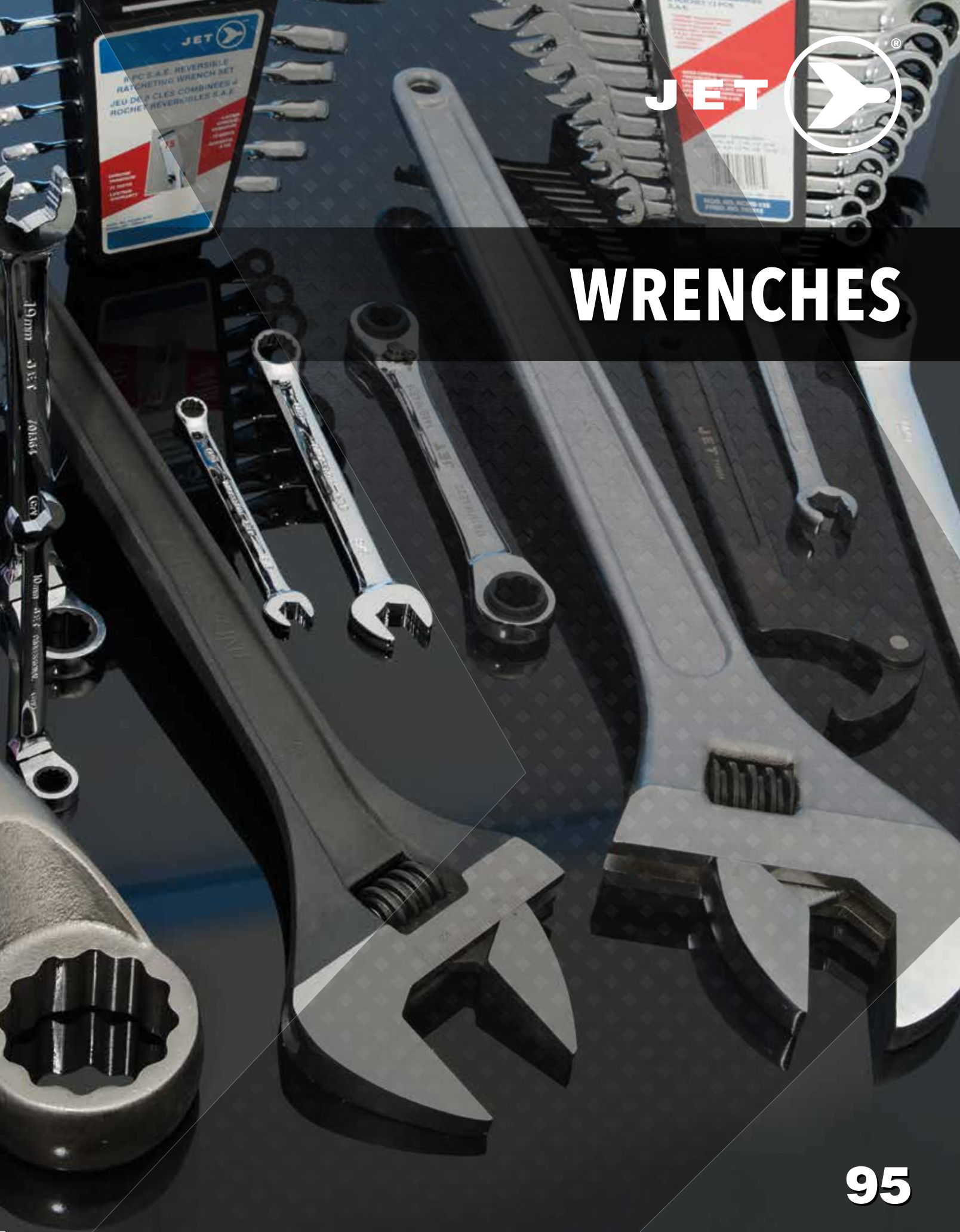

# WRENCHES



**TORQUE DRIVE**



700110



700115



700121



700177



700201

## COMBINATION WRENCHES - RAISED PANEL

- JET raised panel combination wrenches are made with industrial quality SAE 6140 Chrome Vanadium steel (up to 1-1/4" or 32 mm sizes)
- All wrenches feature TORQUE DRIVE® box ends for increased torque
- Wrench size stamped on head for easy identification
- Sets are supplied with industrial strength terylene pouches (except 700201)
- All sets meet ANSI specifications

### SAE Wrench Sets

PROD. NO.	MOD. NO.	Pieces (total)	Size
700110	CWS-6S	6	3/8, 7/16, 1/2, 9/16, 5/8, 3/4" Terylene Pouch
700115	CWS-11S	11	3/8, 7/16, 1/2, 9/16, 5/8, 11/16, 3/4, 13/16, 7/8, 15/16, 1", Terylene Pouch
700121	CWS-16S	16	1/4, 5/16, 3/8, 7/16, 1/2, 9/16, 5/8, 11/16, 3/4, 13/16, 7/8, 15/16, 1, 1-1/16, 1-1/8, 1-1/4", Terylene Pouch

CrV

### Metric Wrench Sets

PROD. NO.	MOD. NO.	Pieces (total)	Size
700167	CWS-11M	11	8, 9, 10, 11, 12, 13, 14, 15, 17, 18, 19 mm Terylene Pouch
700173	CWS-16M	16	7, 8, 9, 10, 11, 12, 13, 14, 15, 16, 17, 18, 19, 21, 22, 24mm, Terylene Pouch
700177	CWS-22M	22	7, 8, 9, 10, 11, 12, 13, 14, 15, 16, 17, 18, 19, 20, 21, 22, 23, 24, 26, 27, 30, 32 mm Terylene Pouch

CrV

### SAE/Metric Wrench Sets

PROD. NO.	MOD. NO.	Pieces (total)	Size
700201	CWS-32SM	32	1/4, 5/16, 3/8, 7/16, 1/2, 9/16, 5/8, 11/16, 3/4, 13/16, 7/8, 15/16, 1, 1-1/16, 1-1/8, 1-1/4" 7, 8, 9, 10, 11, 12, 13, 14, 15, 16, 17, 18, 19, 21, 22, 24 mm

- Blow mould case

CrV



Size stamped on both sides for quick identification (up to 1-1/4" / 32 mm)

Box end features TORQUE DRIVE® pattern for increased torque

## SAE Jumbo Wrench Sets

- JET jumbo wrenches are made with industrial quality S45C Alloy Steel
- Extra heavy drop forgings and premium curved shaft edges ensure maximum strength and comfort
- Not available with TORQUE DRIVE®

PROD. NO.	MOD. NO.	Pieces (total)	Size
700125	JCW-6	6	1-3/8, 1-1/2, 1-5/8, 1-3/4, 1-7/8, 2"
700128	JCW-10-2	10	1-5/16, 1-3/8, 1-7/16, 1-1/2, 1-5/8, 1-11/16, 1-3/4, 1-13/16, 1-7/8, 2"



700128



700521

## SAE Wrenches - Open Stock

- SAE 6140 CrV steel

PROD. NO.	Size
700501	1/4"
700502	5/16"
700503	3/8"
700504	7/16"
700505	1/2"
700506	9/16"
700507	5/8"
700508	11/16"
700509	3/4"
700510	13/16"
700511	7/8"
700512	15/16"
700513	1"
700514	1-1/16"
700515	1-1/8"
700517	1-1/4"



## SAE Jumbo Wrenches - Open Stock

- S45C alloy steel

PROD. NO.	Size
700518	1-5/16"
700519	1-3/8"
700520	1-7/16"
700521	1-1/2"
700523	1-5/8"
700524	1-11/16"
700525	1-3/4"
700526	1-13/16"
700527	1-7/8"
700529	2"
700531	2-1/8"
700533	2-1/4"
700535	2-3/8"
700537	2-1/2"

## Metric Wrenches - Open Stock

- SAE 6140 CrV steel

PROD. NO.	Size
700552	7 mm
700553	8 mm
700554	9 mm
700555	10 mm
700556	11 mm
700557	12 mm
700558	13 mm
700559	14 mm
700560	15 mm
700561	16 mm
700562	17 mm
700563	18 mm
700564	19 mm
700565	20 mm
700566	21 mm
700567	22 mm
700568	23 mm
700569	24 mm
700571	26 mm
700572	27 mm
700575	30 mm
700577	32 mm







## TORQUE DRIVE®



700134



700132



700182



700185



700136



700186

## COMBINATION WRENCHES - FULLY POLISHED

- Exclusive TORQUE DRIVE® non-slip open ends
- Extra long pattern design allows greater torque and improved access to hard to reach areas
- Super strong SAE 6140 Chrome Vanadium steel for strength and durability
- 15° offset - optimal for most applications
- Fully polished mirror finish
- Extra slim design allows access to the most confined spaces
- All wrenches meet ASME and ANSI specifications

### Long Pattern SAE Wrench Sets

PROD. NO.	MOD. NO.	Pieces (total)	Size
700132	LCWS-11S	11	1/4, 5/16, 3/8, 7/16, 1/2, 9/16, 5/8, 11/16, 3/4, 13/16, 7/8" Plastic Rack
700134	LCWS-14S	14	3/8, 7/16, 1/2, 9/16, 5/8, 11/16, 3/4, 13/16, 7/8, 15/16, 1, 1-1/16, 1-1/8, 1-1/4" Terylene Pouch

CrV

### Long Pattern Metric Wrench Sets

PROD. NO.	MOD. NO.	Pieces (total)	Size
700182	LCWS-11M	11	8, 9, 10, 11, 12, 13, 14, 15, 17, 18, 19 mm Plastic Rack
700185	LCWS-16M	16	7, 8, 9, 10, 11, 12, 13, 14, 15, 16, 17, 18, 19, 21, 22, 24 mm Terylene Pouch

CrV

### Extra Long Pattern - Sets

- Same quality features as shown above
- Extra length for hard-to-reach fasteners and greater torque

PROD. NO.	MOD. NO.	Pieces (total)	Size
700136	LCWS-11XLS	11	1/4, 5/16, 3/8, 7/16, 1/2, 9/16, 5/8, 11/16, 3/4, 13/16, 7/8" Plastic Rack
700186	LCWS-11XLM	11	8, 9, 10, 11, 12, 13, 14, 15, 17, 18, 19 mm Plastic Rack

CrV

Long Pattern Wrenches - Open Stock

SAE	
PROD. NO.	Size
700621	1/4"
700622	5/16"
700623	3/8"
700624	7/16"
700625	1/2"
700626	9/16"
700627	5/8"
700628	11/16"
700629	3/4"
700630	13/16"
700631	7/8"
700632	15/16"
700633	1"
700634	1-1/16"
700635	1-1/8"
700637	1-1/4"



Long Pattern Wrenches - Open Stock

METRIC	
PROD. NO.	Size
700672	7 mm
700673	8 mm
700674	9 mm
700675	10 mm
700676	11 mm
700677	12 mm
700678	13 mm
700679	14 mm
700680	15 mm
700681	16 mm
700682	17 mm
700683	18 mm
700684	19 mm
700685	20 mm
700686	21 mm
700687	22 mm
700688	23 mm
700689	24 mm



Extra Long Pattern SAE - Open Stock

SAE	
PROD. NO.	Size
700801	1/4"
700802	5/16"
700803	3/8"
700804	7/16"
700805	1/2"
700806	9/16"
700807	5/8"
700808	11/16"
700809	3/4"
700810	13/16"
700811	7/8"

Extra Long Pattern Metric - Open Stock

METRIC	
PROD. NO.	Size
700853	8 mm
700854	9 mm
700855	10 mm
700856	11 mm
700857	12 mm
700858	13 mm
700859	14 mm
700860	15 mm
700862	17 mm
700863	18 mm
700864	19 mm



Non-slip open ends in series:

FULLY POLISHED COMBINATION WRENCHES

EXTRA LONG FULLY POLISHED COMBINATION WRENCHES

All wrenches feature **TORQUE DRIVE®** box ends for increased torque

Exclusive "non-slip" open ends for increased torque and use on rounded fasteners







## COMBINATION WRENCHES - MULTI-FIT



- Multi-fit box end fits SAE and Metric 6 pt. hex and 12 pt. double hex fasteners, as well as 4 pt. Spline and TORX® fasteners
- Patented open end fits SAE and Metric 6 pt. hex and 4 pt. square fasteners
- Permits use on fasteners when box end cannot be slipped over rod or bolt
- Competing open end designs require the user to purchase separate SAE and Metric sets
- 8 PC set fits 63 different sizes and types of fasteners providing unparalleled versatility
- Super strong SAE 6140 Chrome Vanadium steel for strength and durability
- 15° offset – ideal for most applications
- Fully polished mirror finish with 3 layers of plating for superior corrosion resistance

### 8 PC Multi-Fit Combination Wrench Sets

PROD. NO.	MOD. NO.	Pieces (total)	Size
700212	CWMF-8S	8	See below



### Multi-Fit - Open Stock

BOX END FITS:	6 & 12 pt SAE	6 & 12 pt Metric	4 pt SAE	4 pt Metric	Spline	TORX®
700453	5/16	8	9/32	7	8	E10
700455	3/8	10	11/32	-	10	E12
700456	7/16	11	3/8	9	11	E14
700458	1/2	13	7/16	11	13	E16
700459	9/16	14	15/32	12	14	E18
700461	5/8	16	17/32	13	16	E20
700462	11/16	17	9/16	14	17	E22
700464	3/4	19	5/8	16	19	E24

OPEN END FITS:	6 pt SAE	6 pt Metric	4 pt SAE	4 pt Metric
700453	5/16	8	5/16	8
700455	3/8	10	3/8	10
700456	7/16	11	7/16	11
700458	1/2	13	1/2	13
700459	9/16	14	9/16	14
700461	5/8	16	5/8	16
700462	11/16	17	11/16	17
700464	3/4	19	3/4	18



- Extra short pattern style allows you to access confined areas
- Fully polished for clean professional look and feel
- 12 point TORQUE DRIVE® box end applies force to sides of fasteners, reducing corner rounding and allowing 20% more torque
- 15° offset is optimal for most applications
- Heavy duty drop forged SAE 6140 Chrome Vanadium steel made for professionals
- Meets ANSI Standards

### Stubby SAE Wrench Set

PROD. NO.	MOD. NO.	Pieces (total)	Size
700141	SCWS-7S	7	3/8, 7/16, 1/2, 9/16, 5/8, 11/16, 3/4" Plastic Rack

CrV

### Stubby Metric Combination Wrench Set

PROD. NO.	MOD. NO.	Pieces (total)	Size
700191	SCWS-7M	7	10, 12, 13, 15, 17, 18, 19 mm Plastic rack

CrV



### Stubby SAE Wrenches - Open Stock

PROD. NO.	Size
700703	3/8"
700704	7/16"
700705	1/2"
700706	9/16"
700707	5/8"
700708	11/16"
700709	3/4"

### Stubby Metric Wrenches - Open Stock

PROD. NO.	Size
700755	10 mm
700757	12 mm
700758	13 mm
700760	15 mm
700762	17 mm
700763	18 mm
700764	19 mm

CrV



## TORQUE DRIVE®



700141



700191



## TORQUE DRIVE



700308



700312



700164



700361

## RATCHET WRENCHES - SETS

- Exclusive TORQUE DRIVE® non-slip open ends & 12 point box ends for superior grip
- 72 tooth ratchet mechanism exceeds the ANSI torque ratings for a fixed wrench by more than 30%
- Superior grade 6140 Chrome Vanadium steel
- Flat style allows maximum access to confined areas - just flip wrench over to reverse
- Fully polished surface resists corrosion
- Complete with plastic carrying rack

Non-Reversing



Flip wrench to reverse direction

### Long Pattern SAE Wrench Sets - Non Reversing

PROD. NO.	MOD. NO.	Pieces (total)	Size
700308	RCWS-8S	8	5/16, 3/8, 7/16, 1/2, 9/16, 5/8, 11/16, 3/4"
700312	RCWS-13S	13	1/4, 5/16, 3/8, 7/16, 1/2, 9/16, 5/8, 11/16, 3/4, 13/16, 7/8, 15/16, 1"



### Long Pattern Metric Wrench Sets - Non Reversing

PROD. NO.	MOD. NO.	Pieces (total)	Size
700164	RCWS-7M	7	8, 10, 12, 13, 14, 15, 18 mm
700361	RCWS-12M	12	8, 9, 10, 11, 12, 13, 14, 15, 16, 17, 18, 19 mm



All professional wrenches in this category feature exclusive "non-slip" open ends for increased torque and use on rounded fasteners

- Same great features as flat style, but with reversing lever
- Allows 15° offset for clearance
- Low profile lever does not add height to the box end, maintaining clearance
- Rated at 1.2 x ANSI torque values

Reversing



### Long Pattern SAE Wrench Sets - Reversing

PROD. NO.	MOD. NO.	Pieces (total)	Size
700321	RCWS-8SR	8	5/16, 3/8, 7/16, 1/2, 9/16, 5/8, 11/16, 3/4"
700322	RCWS-13SR	13	1/4, 5/16, 3/8, 7/16, 1/2, 9/16, 5/8, 11/16, 3/4, 13/16, 7/8, 15/16, 1"



### Long Pattern Metric Wrench Sets - Reversing

PROD. NO.	MOD. NO.	Pieces (total)	Size
700371	RCWS-7MR	7	8, 10, 12, 13, 14, 15, 18 mm
700372	RCWS-12MR	12	8, 9, 10, 11, 12, 13, 14, 15, 16, 17, 18, 19 mm



### JET Ratchet Wrenches Other Leading Brand

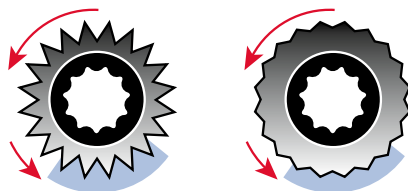

**JET's** deeper broached teeth allow greater torque loads and ensure positive tooth engagement



700321



700322



700371



700372



**TORQUE DRIVE**



700336



700386

**RATCHET WRENCHES - SETS**

- Exclusive TORQUE DRIVE® non-slip open ends & 12 point box ends for superior grip
- 72 tooth ratchet mechanism exceeds the ANSI torque ratings for a fixed wrench by more than 30%
- Superior grade 6140 Chrome Vanadium steel
- Flat style allows maximum access to confined areas - just flip wrench over to reverse
- Fully polished surface resists corrosion
- Complete with plastic carrying rack

**Extra Long Pattern Wrench - Sets**

PROD. NO.	MOD. NO.	Pieces (total)	Size
700336	RCWS-9XLS	9	1/4, 5/16, 3/8, 7/16, 1/2, 9/16, 5/8, 11/16, 3/4"
700386	RCWS-12XLM	12	8, 9, 10, 11, 12, 13, 14, 15, 16, 17, 18, 19mm



Extra long pattern ratcheting wrench is up to 25% longer than traditional wrenches



700331

700381

**Long Pattern Flex Head Wrench - Sets**

- Flex head design allows up to 180° flex for increased access to confined areas
- Light tension holds position while allowing easy adjustment of angle

PROD. NO.	MOD. NO.	Pieces (total)	Size
700331	RCWS-11FS	11	1/4, 5/16, 3/8, 7/16, 1/2, 9/16, 5/8, 11/16, 3/4, 13/16, 7/8"
700381	RCWS-11FM	11	8, 9, 10, 11, 12, 13, 14, 15, 17, 18, 19mm







### SAE Open Stock - Non Reversing

PROD. NO.	Size	PROD. NO.	Size
701101	1/4"	701108	11/16"
701102	5/16"	701109	3/4"
701103	3/8"	701110	13/16"
701104	7/16"	701111	7/8"
701105	1/2"	701112	15/16"
701106	9/16"	701113	1"
701107	5/8"		

### Metric Open Stock - Non Reversing

PROD. NO.	Size	PROD. NO.	Size
701153	8 mm	701159	14 mm
701154	9 mm	701160	15 mm
701155	10 mm	701161	16 mm
701156	11 mm	701162	17 mm
701157	12 mm	701163	18 mm
701158	13 mm	701164	19 mm



### SAE Extra Long Open Stock - Non Reversing

PROD. NO.	Size	PROD. NO.	Size
701201	1/4"	701206	9/16"
701202	5/16"	701207	5/8"
701203	3/8"	701208	11/16"
701204	7/16"	701209	3/4"
701205	1/2"		

### Metric Extra Long Open Stock - Non Reversing

PROD. NO.	Size	PROD. NO.	Size
701253	8 mm	701259	14 mm
701254	9 mm	701260	15 mm
701255	10 mm	701261	16 mm
701256	11 mm	701262	17 mm
701257	12 mm	701263	18 mm
701258	13 mm	701264	19 mm



### SAE Open Stock - Reversing

PROD. NO.	Size	PROD. NO.	Size
701121	1/4"	701128	11/16"
701122	5/16"	701129	3/4"
701123	3/8"	701130	13/16"
701124	7/16"	701131	7/8"
701125	1/2"	701132	15/16"
701126	9/16"	701133	1"
701127	5/8"		

### Metric Open Stock - Reversing

PROD. NO.	Size	PROD. NO.	Size
701173	8 mm	701179	14 mm
701174	9 mm	701180	15 mm
701175	10 mm	701181	16 mm
701176	11 mm	701182	17 mm
701177	12 mm	701183	18 mm
701178	13 mm	701184	19 mm



### SAE Flex Head Open Stock - Non Reversing

PROD. NO.	Size	PROD. NO.	Size
701301	1/4"	701307	5/8"
701302	5/16"	701308	11/16"
701303	3/8"	701309	3/4"
701304	7/16"	701310	13/16"
701305	1/2"	701311	7/8"
701306	9/16"		

### Metric Flex Head Open Stock - Non Reversing

PROD. NO.	Size	PROD. NO.	Size
701353	8 mm	701359	14 mm
701354	9 mm	701360	15 mm
701355	10 mm	701362	17 mm
701356	11 mm	701363	18 mm
701357	12 mm	701364	19 mm
701358	13 mm		



## RATCHETING WRENCHES

### 63-In-1 Multi-Fit Ratcheting Wrench Set

700392/MFRW-6300

- Multi-fit design fits SAE and Metric 6 point hex and 12 point double hex fasteners, as well as 4 point, Spline, and E-Torx fasteners
- 2 piece set fits 63 different sizes and types of fasteners providing unparalleled versatility
- 72 tooth ratcheting gear allows for just 5° swing arc for use in restricted spaces
- Premium quality SAE 6140 chrome vanadium steel for strength and durability
- Fully polished mirror finish with 3 layers of plating for superior corrosion resistance



FITS:	6 & 12 pt SAE	6 & 12 pt Metric	4 pt SAE	4 pt Metric	Spline	E-Torx
	5/16	8	9/32	7	8	E10
	3/8	10	11/32	-	10	E12
	7/16	11	3/8	9	11	E14
	1/2	13	7/16	11	13	E16
	9/16	14	15/32	12	14	E18
	5/8	16	17/32	13	16	E20
	11/16	17	9/16	14	17	E22
	3/4	19	5/8	16	19	E24

#### Open Stock

##### PROD. NO.

700408	Fits 8-13 above	8 x 13 Multi-Fit Ratchet
700414	Fits 14-19 above	14 x 19 Multi-Fit Ratchet

### 4 PC Ratchet Wrench Adapter Set

701196 / RWAS-4S

- 1/4", 3/8", and 1/2" socket adapters and 1/4" hex bit adapter provide maximum versatility by turning your ratcheting wrench set into a full wrench, bit, and socket drive set
- Converts the wrench into an extremely low profile ratchet for access to the most limited spaces
- Works with flat, reversing, and flex head ratcheting combination wrenches
- Requires 3/8", 1/2", and 3/4" ratcheting wrenches (sold separately)
- Available in 4 pc set only

##### CONTENTS:

- **1/4" hex bit adapter** for use with 3/8" ratcheting wrench
- **1/4" drive socket adapter** for use with 3/8" ratcheting wrench
- **3/8" drive socket adapter** for use with 1/2" ratcheting wrench
- **1/2" drive socket adapter** for use with 3/4" ratcheting wrench
- Ratchet wrenches sold separately



Adapter set converts ratcheting combination wrenches to socket or bit drivers



Socket adapters complete with quick release feature



## FLARE NUT WRENCHES



- Flare nut wrenches are used on fasteners found on tubing ends or hoses, such as brake lines, hydraulic fittings, plumbing, etc
- Slot opening easily slides over tubing or hose to reach hex nuts at ends
- 6 point design allows for maximum contact on fastener for evenly distributed torque
- Reduces fastener damage

### Flare Nut Wrench Sets

PROD. NO.	MOD. NO.	Type	Pieces (total)	Size	Holder
719001	FN-3	SAE	3	3/8" x 7/16" 1/2" x 9/16" 5/8" x 11/16"	Plastic Pouch
719006	FN-3M	Metric	3	10 x 11mm 12 x 13mm 15 x 17mm	Plastic Pouch



### Flare Nut Wrenches - Open Stock

PROD. NO.	Type	Size
719002	SAE	3/8" x 7/16"
719003	SAE	1/2" x 9/16"
719004	SAE	5/8" x 11/16"
719007	Metric	10 x 11mm
719008	Metric	12 x 13mm
719009	Metric	15 x 17mm



## CROWFOOT WRENCHES

- Sets include rail
- Used in restricted access spaces where a flare nut wrench cannot reach
- Slot opening easily slides over tubing or hose to reach hex nuts at ends
- Fully polished

PROD. NO.	MOD. NO.	Pieces	Drive	Size	Holder
719111	FNC-8	8	3/8"	3/8, 7/16, 1/2, 9/16, 5/8, 11/16, 3/4, 7/8"	Socket Rail
719121	FNC-10M	10	3/8"	10, 11, 12, 13, 14, 15, 16, 17, 18, 19mm	Socket Rail





## ADJUSTABLE WRENCHES

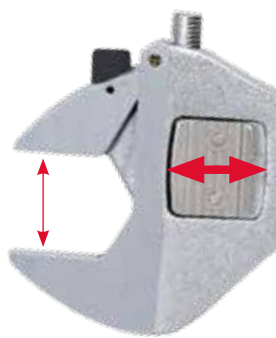

### Quick Snap Adjustable Wrench

- Patented adjustment plate and tooth system eliminates old fashioned knurl and is 5 times faster than traditional systems
- Pulling down on adjustment plate disengaged teeth and allows quick adjustment by simply pushing moving jaw until it meets fastener
- Dual frequency teeth guarantee exact fit on both SAE and Metric Fasteners
- Virtually no jaw play means no need to fine adjust wrench between fasteners
- Jaw remains parallel at all widths
- SAE and Metric scales for measuring fasteners
- 15° jaw angle provides greater leverage than standard 22° wrenches, reducing fatigue
- Heat treated chrome vanadium steel for professional use
- Dual material moulded grip for comfort and increased force

PROD. NO.	MOD. NO.	Length	Opening	Material
711191	JQSW-8	8"	1"	CrV

**NEW**

**JET**  
EXCLUSIVE



711102

### Adjustable Wrench Set

- Professional quality
- Drop forged Chrome Vanadium steel
- Fully heat treated for strength and durability
- Accurately machined sliding jaw for smooth adjustment
- Traditional handle design

PROD. NO.	MOD. NO.	Length	Pieces	Opening	Material
711102	AW-3S	8", 10", 12"	3	1", 1-1/4", 1-1/2"	CrV

CrV

### Adjustable Wrenches - Open Stock

PROD. NO.	MOD. NO.	Length	Opening	Material
711111	AW-4	4" (100 mm)	1	CrV
711112	AW-6	6" (160 mm)	3/4"	CrV
711113	AW-8	8" (210 mm)	1"	CrV
711114	AW-10	10" (250 mm)	1-1/4"	CrV
711115	AW-12	12" (300 mm)	1-1/2"	CrV
711116	AW-15	15" (380 mm)	1-7/8"	Alloy
711117	AW-18	18" (450 mm)	2-1/8"	Alloy
711118	AW-24	24" (600 mm)	2-1/2"	Alloy

CrV



## Professional Adjustable Wrenches - Super Heavy Duty

- Smaller 15° jaw angle provides greater leverage than standard 22° wrenches, reducing hand and arm fatigue
- Extra wide jaw openings fit an increased range of fasteners, offering greater versatility and value
- Thin tapered jaw reaches fasteners in narrow spaces with ease
- Jaw rack does not protrude past jaw when wrench is fully open, increasing clearance in tight access areas
- Thicker handle provides improved comfort and allows increased application of force
- SAE and Metric scales laser printed on jaws for convenient sizing of fasteners

PROD. NO.	MOD. NO.	Length	Opening	Material
711132	AWP-6	<b>6" (160 mm)</b>	7/8"	CrV
711133	AWP-8	<b>8" (210 mm)</b>	1"	CrV
711134	AWP-10	<b>10" (250 mm)</b>	1-3/16"	CrV
711135	AWP-12	<b>12" (300 mm)</b>	1-3/8"	CrV
711136	AWP-15	<b>15" (380 mm)</b>	1-15/16"	CrV
711137	AWP-18	<b>18" (450 mm)</b>	2-3/8"	CrV
711139	AWP-24	<b>24" (600 mm)</b>	2-1/2"	CrV



## Industrial Adjustable Wrenches - Black Phosphate Finish - Super Heavy Duty

- Chrome Vanadium steel wrenches with black phosphate finish for use in applications where plated products are prohibited
- No chrome plate to peel or chip, causing contamination in sensitive applications
- Finish is non-reflective for military applications
- Black phosphate provides superior corrosion resistance versus black oxide finishes

PROD. NO.	MOD. NO.	Length	Opening	Material
711152	AWP-6B	<b>6" (160 mm)</b>	15/16"	CrV
711153	AWP-8B	<b>8" (210 mm)</b>	1-1/8"	CrV
711154	AWP-10B	<b>10" (250 mm)</b>	1-5/16"	CrV
711155	AWP-12B	<b>12" (300 mm)</b>	1-1/2"	CrV
711156	AWP-15B	<b>15" (380 mm)</b>	2"	CrV
711157	AWP-18B	<b>18" (450 mm)</b>	2-5/16"	CrV
711159	AWP-24B	<b>24" (600 mm)</b>	2-3/4"	CrV



711154

711157





715216

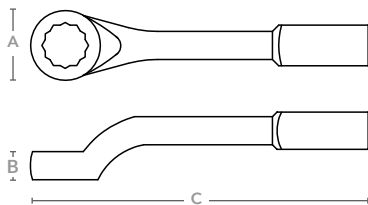

Special chamfering keeps wrench on fastener

## STRIKING WRENCHES

### SAE - Offset Style

- Drop forged Chrome Vanadium steel
- Heat treated for maximum strength
- Offset design allows clearance over work
- 12 point design for decreased swing room
- Special chamfering keeps wrench on fastener
- Protective coating minimizes corrosion
- Meets US Government standard GGG-W-636E and ANSI specifications
- 35 hex sizes from 1 - 3-1/8"

PROD. NO.	Size	Head Width (A)	Head Thickness (B)	Overall Length (C)
715201	<b>1"</b>	1-25/32"	25/32"	10-5/8"
715202	<b>1-1/16"</b>	1-25/32"	25/32"	10-5/8"
715203	<b>1-1/8"</b>	1-15/16"	7/8"	11"
715204	<b>1-3/16"</b>	1-15/16"	7/8"	11"
715205	<b>1-1/4"</b>	2-3/32"	29/32"	11-7/16"
715206	<b>1-5/16"</b>	2-3/32"	29/32"	11-7/16"
715207	<b>1-3/8"</b>	2-7/16"	31/32"	11-13/16"
715208	<b>1-7/16"</b>	2-7/16"	31/32"	11-13/16"
715209	<b>1-1/2"</b>	2-5/8"	1-1/32"	12-5/8"
715210	<b>1-9/16"</b>	2-5/8"	1-1/32"	12-5/8"
715211	<b>1-5/8"</b>	2-5/8"	1-1/32"	12-5/8"
715212	<b>1-11/16"</b>	2-5/8"	1-1/32"	12-5/8"
715213	<b>1-3/4"</b>	2-7/8"	1-1/16"	13-3/8"
715214	<b>1-13/16"</b>	2-7/8"	1/1/16"	13-3/8"
715215	<b>1-7/8"</b>	2-7/8"	1-1/16"	13-3/8"
715216	<b>1-15/16"</b>	3-1/16"	1-1/4"	13-3/4"
715217	<b>2"</b>	3-1/16"	1-1/4"	13-3/4"
715218	<b>2-1/16"</b>	3-5/16"	1-5/16"	4-3/16"
715219	<b>2-1/8"</b>	3-5/16"	1-5/16"	14-3/16"
715220	<b>2-3/16"</b>	3-5/16"	1-5/16"	14-3/16"
715221	<b>2-1/4"</b>	3-17/32"	1-3/8"	14-3/4"
715222	<b>2-5/16"</b>	3-17/32"	1-3/8"	14-3/4"
715223	<b>2-3/8"</b>	3-17/32"	1-3/8"	14-3/4"
715224	<b>2-7/16"</b>	3-17/32"	1-3/8"	14-3/4"
715225	<b>2-1/2"</b>	3-25/32"	1-1/2"	15-3/8"
715226	<b>2-9/16"</b>	3-25/32"	1-1/2"	15-3/8"
715227	<b>2-5/8"</b>	3-25/32"	1-1/2"	15-3/8"
715228	<b>2-11/16"</b>	4-1/8"	1-5/8"	15-3/4"
715229	<b>2-3/4"</b>	4-1/8"	1-5/8"	15-3/4"
715230	<b>2-13/16"</b>	4-1/8"	1-5/8"	15-3/4"
715231	<b>2-7/8"</b>	4-11/32"	1-11/16"	16-9/16"
715232	<b>2-15/16"</b>	4-11/32"	1-11/16"	16-9/16"
715233	<b>3"</b>	4-11/32"	1-11/16"	16-9/16"
715234	<b>3-1/16"</b>	4-21/32"	1-25/32"	17-5/16"
715235	<b>3-1/8"</b>	4-21/32"	1-25/32"	17-5/16"



## SAE - Offset Style

- Drop forged Chrome Vanadium steel
- Heat treated for maximum strength
- Offset design allows clearance over work
- Round tapered stock allows use as aligning bar
- Protective coating minimizes corrosion
- Meets US government standard GGG-W-636E

PROD. NO.	Size	Head Width (A)	Head Thickness (B)	Overall Length (C)
719151	<b>3/4"</b>	1-3/4"	13/32"	13-1/8"
719153	<b>7/8"</b>	2-9/32"	7/16"	13-3/4"
719154	<b>15/16"</b>	2-9/32"	7/16"	14-5/8"
719155	<b>1"</b>	2-9/32"	7/16"	14-5/8"
719156	<b>1-1/16"</b>	2-9/32"	7/16"	14-5/8"
719157	<b>1-1/8"</b>	2-1/2"	19/32"	14-5/8"
719159	<b>1-1/4"</b>	2-1/2"	19/32"	15-3/4"
719162	<b>1-7/16"</b>	3-1/16"	23/32"	16-7/8"
719163	<b>1-1/2"</b>	3-1/16"	23/32"	18-1/2"
719165	<b>1-5/8"</b>	3-5/8"	23/32"	18-1/2"

CrV

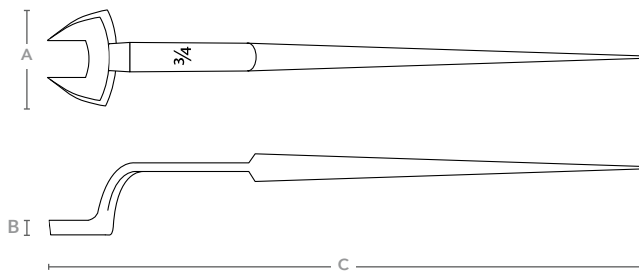

## 15" Adjustable Construction Wrench

- Drop forged heat treated steel for professional use
- Adjustable up to 1-5/8" for maximum convenience
- Eliminates the need to carry multiple wrenches
- Tapered shaft aids in aligning bolt holes
- Continuous taper reduces binding
- Precisely ground jaws remain parallel at all opening widths for better grip
- Ultra smooth acting knurl for fast adjustment
- Flat neck allows use of lanyard for added safety

PROD. NO.	MOD. NO.	Head Width (A)	Head Thickness (B)	Overall Length (C)
711146	<b>AWC-15</b>	3-1/2"	5/8"	15-3/4"



719151



## ADJUSTABLE SPANNER WRENCHES

- Black oxide finish resists corrosion
- Adjustable wrenches fit a wide variety of sizes
- Slotted or pin style wrenches
- For use on collars, locknut rings and bearings



### Hook Style

PROD. NO.	MOD. NO.	Length	Capacity	Type
710902	JHSW-102	6-1/2"	3/4 - 2"	Hook
710903	JHSW-103	8"	1-1/4 - 3"	Hook
710904	JHSW-104	11-1/2"	2 - 4-3/4"	Hook

### Pin Style

PROD. NO.	MOD. NO.	Length	Capacity	Pin Size	Type
710912	JPSW-102	6-1/2"	3/4 - 2"	<b>1/8"</b>	Pin
710913	JPSW-103	8"	1-1/4 - 3"	<b>3/16"</b>	Pin
710914	JPSW-104	11-1/2"	2 - 4-3/4"	<b>1/4"</b>	Pin



# HEX KEY WRENCHES







775144



775146



775153



775156



775192



775112



775114



775191

## HEX KEY WRENCHES - SETS

### Folding Hex and TORX® Key Sets

- Fully hardened steel case with ergonomic bi-material grip for added comfort and sure grip
- Steel reinforced on inside for maximum strength
- Heat treated Chrome Vanadium steel keys
- Unique offset washers between keys applies tension, holding keys firmly in place while in use

PROD. NO.	MOD. NO.	Pieces	Sizes
775144	JFHK-9	9	5/64, 3/32, 7/64, 1/8, 9/64, 5/32, 3/16, 7/32, 1/4"
775146	JFHK-7L	7	1/8, 5/32, 3/16, 7/32, 1/4, 5/16, 3/8"
775153	JFHK-7M	7	1.5, 2, 2.5, 3, 4, 5, 6 mm
775156	JFHK-7ML	7	3, 4, 5, 5.5, 6, 8, 10 mm
775192	JFTK-8	8	T8, T10, T15, T20, T25, T27, T30, T40



### Short Arm Hex and TORX® Key Sets

- Precision chamfering for ease of insertion
- Industrial heat treated Chrome Vanadium steel
- Convenient carrying case keeps hex keys organized

PROD. NO.	MOD. NO.	Pieces	Sizes
775112	JHK-13	13	0.05, 1/16, 5/64, 3/32, 7/64, 1/8, 9/64, 5/32, 3/16, 7/32, 1/4, 5/16, 3/8"
775114	JHK-9M	9	1.5, 2.0, 2.5, 3.0, 4.0, 5.0, 6.0, 8.0, 10 mm
775191	JTK-9TP	9	T10, T15, T20, T25, T27, T30, T40, T45, T50



TORX® is a registered trademark of Acument Intellectual Properties, LLC.



## Long Arm Ball Nose Sets

- Long arm series allows access into tough spots and more torque on the fastener
- Ball nose design allows engagement of fastener at up to 25° angle
- Precision chamfering for ease of insertion
- Industrial heat treated Chrome Vanadium steel
- Convenient carrying case keeps hex keys organized
- 22 PC sets combine 13 PC SAE and 9 PC Metric with a convenient centre post that converts to a comfortable T or L-Handle
- All items meet ANSI standards for hardness and torque



Centre post converts to a T or L-handle



775164

PROD. NO.	MOD. NO.	Pieces	Sizes
775164	JBHK-22SM	22	0.05, 1/16, 5/64, 3/32, 7/64, 1/8, 9/64, 5/32, 3/16, 7/32, 1/4, 5/16, 3/8", 1.5, 2.0, 2.5, 3.0, 4.0, 5.0, 6.0, 8.0, 10.0 mm
775173	JBHK-10	10	1/16, 5/64, 3/32, 1/8, 5/32, 3/16, 7/32, 1/4, 5/16, 3/8"
775184	JBHK-9M	9	1.5, 2.0, 2.5, 3.0, 4.0, 5.0, 6.0, 8.0, 10.0 mm



## Long Arm Flat Nose Set

- Same quality features as 775164, except with flat nose at both ends of the hex key

PROD. NO.	MOD. NO.	Pieces	Sizes
775162	JHK-22SM	22	0.05, 1/16, 5/64, 3/32, 7/64, 1/8, 9/64, 5/32, 3/16, 7/32, 1/4, 5/16, 3/8", 1.5, 2.0, 2.5, 3.0, 4.0, 5.0, 6.0, 8.0, 10.0 mm



775173

775184



775162



775175

775185



775186



## HEX KEY WRENCHES - SETS

### Extra Long Ball Nose Sets

- Extra long - up to 30% longer than conventional hex long arm keys. Improves reach and provides more torque
- Hex end for extra torque - use for initial loosening and final tightening
- Ball nose allows angle entry - perfect for blind applications
- Super bright finish for excellent rust resistance
- S2 alloy steel hardened to HRC58-62 allows 50% more torque than CrV keys
- Improved folding case for easier access to smaller sizes
- Exceeds ANSI standards for hardness and torque

PROD. NO.	MOD. NO.	Pieces	Sizes
775175	JBHK-9XL	9	1/16, 5/64, 3/32, 1/8, 5/32, 3/16, 1/4, 5/16, 3/8"
775185	JBHK-9XLM	9	1.5, 2.0, 2.5, 3.0, 4.0, 5.0, 6.0, 8.0, 10.0 mm



### Jumbo Extra Long Ball Nose Sets

- Same great features our Extra Long Ball Nose series except with larger sizes for all heavy duty applications
- Complete with handy organizer

PROD. NO.	MOD. NO.	Pieces	Sizes
775176	JBHK-17XL	17	0.05, 1/16, 5/64, 3/32, 7/64, 1/8, 9/64, 5/32, 3/16, 7/32, 1/4, 5/16, 3/8, 1/2, 9/16, 5/8, 3/4"
775186	JBHK-17LM	17	1.3, 1.5, 2.0, 2.5, 3.0, 3.5, 4.0, 5.0, 5.5, 6.0, 7.0, 8.0, 10, 12, 14, 17, 19 mm



### T-Handle Hex Key / Torx® Key Sets

- PVC grip provides comfort and allows increased torque
- S2 alloy steel hardened to HRC58-62 for maximum strength and endurance
- Flat nose design for highest torque on the torque on the toughest fasteners
- Colour coded to indicate SAE, Metric, or Torx® sizes
- Manganese phosphate finish resists corrosion

PROD. NO.	MOD. NO.	Description	Sizes
775109	JTHK-10	10 PC SAE T Handle Hex Key Set	3/32, 7/64, 1/8, 9/64, 5/32, 3/16, 7/32, 1/4, 5/16, 3/8"
775105	JTHK-8M	8 PC Metric T Handle Hex Key Set	2.0, 2.5, 3.0, 4.0, 5.0, 6.0, 8.0, 10.0 mm
775103	JTTK-7	7 PC T Handle Torx Key Set	T10, T15, T20, T25, T30, T40, T45

**NEW**

## L-Handle Style Hex and TORX® Key Sets

- Hard composite material combined with soft rubber form a unique ergonomic handle for optimal grip and unsurpassed comfort
- Handles are moulded around keys ensuring maximum strength and preventing keys and handles from separating
- S2 alloy steel hardened to HRC58-62 allows 50% more torque than CrV keys
- Super long keys for maximum reach - our longest hex keys
- Ball nose allows angle entry - perfect for blind applications (Hex Key Only)
- Short end for extra torque - use for initial loosening and final tightening
- TORX® keys are regular style on one end and tamperproof on the other
- Super bright finish for excellent rust resistance
- Exceeds ANSI standards for hardness and torque
- Comes with blow mould case

PROD. NO.	MOD. NO.	Pieces	Sizes
775104	JTHK-9	9	5/64, 3/32, 1/8, 5/32, 3/16, 7/32 1/4, 5/16, 3/8"
775106	JTHK-9M	9	2.0, 2.5, 3.0, 4.0, 5.0, 5.5, 6.0, 8.0, 10.0 mm
775108	JTTK-9	9	T10, T15, T20, T25, T27, T30, T40, T45, T50



## Short/Long Arm Combination SAE/Metric Set

- Keys made of heat treated Chrome Vanadium steel
- Quality set at an economical price
- SAE keys are long arm, Metric keys are short arm
- Complete with blow mould carrying case

PROD. NO.	MOD. NO.	Pieces	Sizes
775165	JHK-25SM	25	<b>Long Arm</b> 1/16, 5/64, 3/32, 7/64, 1/8, 9/64, 5/32, 3/16, 7/32, 1/4, 5/16, 3/8"
			<b>Short Arm</b> 1.5, 2.0, 2.5, 3.0, 4.0, 4.5, 5.0, 5.5, 6.0, 7.0, 8.0, 9.0, 10.0 mm



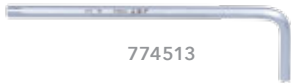

774513



774517

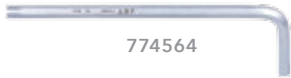

774564

## HEX KEY WRENCHES

### Hextractor™ Hex Key - Sets

- Patented design bites into rounded fasteners, making removal fast and easy
- Hextractor teeth on both ends of key provide extra torque or increased reach
- Works on left and right hand threaded fasteners
- Safe for use on undamaged fasteners
- Heat treated S2 steel allows up to 50% more torque than CrV hex Keys
- Patented case can be used as a T handle while still keeping keys organized
- Case includes belt clip and hanger for convenient storage

PROD. NO.	MOD. NO.	Pieces	Sizes
775122	JHHK-8	8	5/64, 3/32, 1/8, 5/32, 3/16, 1/4, 5/16, 3/8"
775127	JHHK-8M	8	2, 2.5, 3, 4, 5, 6, 8, 10 mm



### HEXTRACTOR™ HEX KEY - OPEN STOCK

PROD. NO.	Description
774507	5/64"
774508	3/32
774510	1/8
774512	5/32
774513	3/16"
774515	1/4"
774517	5/16"
774519	3/8"
774557	2 mm
774558	2.5 mm
774559	3 mm
774560	4 mm
774562	5 mm
774564	6 mm
774566	8 mm
774568	10 mm

# HEX KEY WRENCHES - OPEN STOCK



Set #	775165	775164 775173	775175 775176	775104	775109
SAE	Long Arm	CrV Long Ball Nose	S2 Extra Long Ball Nose	S2 L-Handle	T-Handle
0.05"		774905	775005		
1/16"	774806	774906	775006		
5/64"	774807	774907	775007	774607	
3/32"	774808	774908	775008	774608	774408
7/64"	774809	774909	775009		774409
1/8"	774810	774910	775010	774610	774410
9/64"	774811	774911	775011		774411
5/32"	774812	774912	775012	774612	774412
3/16"	774813	774913	775013	774613	774413
7/32"	774814	774914	775014	774614	774414
1/4"	774815	774915	775015	774615	774415
5/16"	774817	774917	775017	774617	774417
3/8"	774819	774919	775019	774619	774419
1/2"			775021		
9/16"			775022		
5/8"			775023		
3/4"			775025		

**NEW**



774619



774699





774668



774668

## HEX KEY WRENCHES - OPEN STOCK

Set #	775165	775164 775184	775185 775186	775106	775105
Metric	Short Arm	CrV Long Ball Nose	S2 Extra Long Ball Nose	S2 L-Handle	T-Handle
1.3 mm			775054		
1.5 mm	774756	774956	775056		
2.0 mm	774757	774957	775057	774657	774457
2.5 mm	774758	774958	775058	774658	774458
3.0 mm	774759	774959	775059	774659	774459
3.5 mm			775060		
4.0 mm	774760	774960	775061	774660	774460
4.5 mm	774761				
5.0 mm	774762	774962	775063	774662	774462
5.5 mm	774763		775064	774663	
6.0 mm	774764	774964	775065	774664	774464
7.0 mm	774765		775067		
8.0 mm	774766	774966	775069	774666	774466
9.0 mm	774767				
10.0 mm	774768	774968	775073	774668	774468
12.0 mm			775075		
14.0 mm			775077		
17.0 mm			775080		
19.0 mm			775082		

**NEW**

## TORX® KEY WRENCHES - OPEN STOCK

Set #	775108	775103
TORX®	S2 L-Handle	T-Handle
T10	774691	774491
T15	774692	774492
T20	774693	774493
T25	774694	774494
T27	774695	
T30	774696	774496
T40	774697	774497
T45	774698	774498
T50	774699	



# TORQUE WRENCHES





Bubble magnifier analogue scale

## TORQUE WRENCHES

### JTW Series

- 24 tooth Chrome Vanadium ratchet gear (Chrome Molybdenum on 3/4" model)
- Reversible ratchet
- Dual ft/lb and Nm scales
- Patented lock ring
- Comfortable ergonomic handle grip
- Complete with protective blow mould case
- Perceptible jolt and audible click to indicate desired setting has been reached
- All models are factory calibrated to +/-4% with certificate and meet ISO 6789 - 1992, ANSI specifications, BSEN 26789-1994 and U.S. Government Federal Specifications GGG-W-00686C

PROD. NO.	MOD. NO.	Drive	Torque Range	Length
718902	JTW-1425	1/4"	40-250 in/lb (6-30Nm)	13-3/4"
718908	JTW-3880	3/8"	15-80 ft/lb (19-110Nm)	15-1/4"
718911	JTW-12150	1/2"	30-150 ft/lb (40-210Nm)	21"
718912	JTW-12250	1/2"	50-250 ft/lb (70-350Nm)	25-1/2"
718918	JTW-34600	3/4"	100-600 ft/lb (140-700Nm)	43"
718922	JTW-10700	1"	135-700 ft/lb (135-949Nm)	48"



### JMTW Slim Head Series - Heavy Duty

- Easy to use micrometer adjustment with locking nut or button
- Reversible ratchet
- Perceptible jolt and audible click to indicate desired setting has been reached
- Clearly visible analogue scale with exclusive bubble magnifier
- Patented lock button in the handle
- May be used on left and right hand threads simply by pushing the drive plug through the wrench
- Built tough for demanding professionals
- Factory calibrated to +/-4%
- Meets US Government Federal specification GGG-W-00686C

PROD. NO.	MOD. NO.	Drive	Torque Range	Length
718906	JMTW-3800	3/8"	10-80 ft/lb (10-100 Nm)	16"
719069	JMTW-5250	1/2"	30-250 ft/lb (30-340Nm)	24"

JET offers certified recalibration service on torque wrenches

## JPTW Series - Heavy Duty

- Measures torque in both directions with just a flip of the direction lever - no need to push anvil through wrench
- Reversible ratchet
- 32 tooth configuration requires just 11.5° swing room
- Pull-down locking ring above handle grip securely holds set torque value
- Quick release ratchet holds sockets on until released
- Permanently etched scale will not fade or wear off
- Rubber over-moulded handle for safe, secure grip
- Reinforced pawl blocks for maximum strength
- Accurate to 4% CW, 6% CCW
- All models are factory calibrated with certificate and meet ISO 6789 - 1992, ANSI specifications, BSEN 26789-1994 and U.S. Government Federal Specifications GGG-W-00686C

PROD. NO.	MOD. NO.	Drive	Torque Range	Length
718933	JPTW-38100	3/8"	20 - 100 ft/lb	18-1/2"
718936	JPTW-12250	1/2"	50 - 250 ft/lb	22"



Convenient pull-down locking ring



Quick release head

718936

## TORQUE WRENCHES

### JSHD Series - Super Heavy Duty

- Magnified view window shows torque value in numbers only - no scale lines to read!
- Highest quality Japanese spring resists fatigue for long service life
- Patented dual roller reaction bar system minimizes friction for increased accuracy
- Hardened steel tube will not deflect under strain and will not be scratched by internal parts, ensuring reduced friction and highest possible accuracy
- Conversion scale permanently etched into tube for easy conversion to Nm
- Patented positive lock prevents accidental adjustment of torque value
- Quick release ratchet holds sockets on until released
- Sure grip handle with finger groove ensures correct placement of hand for better accuracy
- 48 tooth quick release reversible ratchet head - our best!
- Drop forged Chrome Molybdenum ratchet pawls for maximum strength
- Lifetime tested to a minimum of 3 x ISO standards



Quick release head



PROD. NO.	MOD. NO.	Drive	Torque Range	Length
718952	JSHD-14250	1/4"	50 - 250 in/lb	12-3/4"
718956	JSHD-3875	3/8"	15 - 75 ft/lb	15-3/4"
718961	JSHD-12150	1/2"	30 - 150 ft/lb	20-3/8"
718962	JSHD-12250	1/2"	50 - 250 ft/lb	24-1/2"



### Torque Screwdriver

- 1/4" drive screwdriver can be used with 1/4" hex bits or 1/4" drive sockets
- 10 - 50 in/lb torque range
- Complete with assortment of 20 popular bits
- Comes in handy blow mould case

PROD. NO.	MOD. NO.	Drive	Torque Range	Length
718991	JTSD-1450K	1/4"	10-50 in/lb	6"



JET offers certified recalibration service on torque wrenches





### Digital Torque Wrenches

- Digital readout signals torque audibly and visually
- 12 multi coloured lights with beeper signal torque even when display cannot be read
- Measures torque in both directions
- Accurate to +/-2% CW, +/-3% CCW from 20% - 100% of scale
- Quickly converts between in/lb, ft/lb, cm/kg, and Nm scales
- Stores up to 9 torque values for quick access to commonly used settings
- Display tracks torque as it is applied or can be set to display peak torque
- Records up to 50 Peak Hold values for accurate record keeping
- Large handle features soft touch TPR grip for user comfort
- Industrial quality 36 tooth sealed ratchet head
- Simple intuitive menu
- Meets ISO 6789-1992 and ANSI standards
- Blow mould case

PROD. NO.	MOD. NO.	Drive	Torque Range	Length
718941	JDTW-14250	1/4"	<b>13.3 - 265.5 in/lb</b> 1.5 - 30Nm	15-11/32"
718943	JDTW-38100	3/8"	<b>5 - 99.5 ft/lb</b> 6.8 - 135Nm	16-5/16"
718946	JDTW-12250	1/2"	<b>12.5 - 250.5 ft/lb</b> 17 - 340Nm	25-1/2"

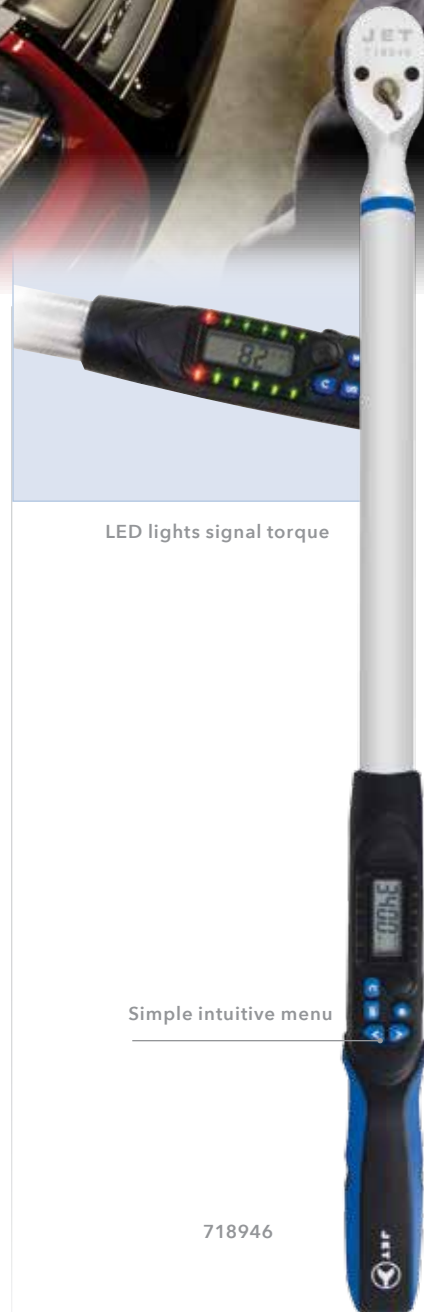

LED lights signal torque

Simple intuitive menu

718946

JET offers certified recalibration service on torque wrenches



## TORQUE MULTIPLIERS - HEAVY DUTY



Reaction base and 90° reaction bar

- Used to multiply applied force for setting and removing high torque fasteners
- Planetary gear system multiples input force many times
- Torque multipliers lower physical effort, resulting in smooth, steady application of torque and increased accuracy
- Permits application of high torque without use of a long lever
- Can be driven with a torque wrench
- Kit includes straight and 90° reaction bars with reaction base (base not included in 719071 kit)
- 90° bar and base rests against truck wheel rims when used to torque lug nuts
- 1/2" drive models available with 3.3:1, 6.5:1 and 12:1 torque ratios
- Higher ratios require lower input forces, reducing operator effort
- All models include breakaway input adapter to protect wrench from overload

### JTM Series Kits

PROD. NO.	MOD. NO.	Input Drive	Output Drive	Gear Ratio	Torque Ratio	Max. Input	Max. Output
719071	JTM-50750	1/2"	3/4"	4:1	3.3:1	227 ft/lb	750 ft/lb
719072	JTM-51100	1/2"	3/4"	9:1	6.5:1	170 ft/lb	1,100 ft/lb
719074	JTM-51850	1/2"	1"	16:1	12:01	154 ft/lb	1,850 ft/lb
719075	JTM-71850	3/4"	1"	4:1	3.3:1	560 ft/lb	1,850 ft/lb



719071



719075



**WARNING:** Do not use impact tools with torque multipliers. Serious damage or injury could occur.





# SCREWDRIVERS BITS NUT DRIVERS





720505



720956



720574



720507



**WARNING:** Insulated handles rated for use to 220V only. Do not use on higher voltage circuits. Not for use on live circuits

## JUMBO HANDLE SERIES – SETS

- Jumbo grip grooved handle design ensures maximum torque for tough jobs
- Made with super acetates these handles are virtually indestructible
- Shafts made of the highest quality Chrome Vanadium steel for long life and maximum durability
- Black hardened magnetic tips eliminate chrome plating chipping off the tip (common on other brands); holds the screw to the screwdriver and ensures maximum durability and life
- All items meet ANS Specifications, U.S. Specifications GGG-S-121E and Canadian Government specifications CDA39-GP-17C

### 6 PC Basic Set

720505 / JHSS-6

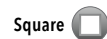

1/4 x 4"  
5/16 x 6"

#1 x 3"  
#2 x 4"

#1 x 4"  
#2 x 5"

- Handy storage rack



### 6 PC Torx® Set

720956 / JHTSS-6



T10 x 4", T15 x 4", T20 x 4", T25 x 4", T27 x 4", T30 x 4"

- Terylene Pouch



### 13 PC Mechanic's Set

720574 / JHMSS-13



1/4 x 1-1/2"  
1/4 x 4"  
5/16 x 6"  
3/8 x 10"

#1 x 3"  
#2 x 1-1/2"  
#2 x 4"

T10 x 4"  
T15 x 4"  
T20 x 4"  
T25 x 4"  
T27 x 4"  
T30 x 4"

- Supplied in convenient blow mould tray



### 14 PC Master Set

720507 / JHSS-14



#2 x 1-1/2"  
#1 x 3"  
#2 x 4"  
#3 x 6"

#2 x 1-1/2"  
#1 x 4"  
#2 x 5"  
#3 x 6"

1/4 x 1-1/2"  
1/4 x 4"  
5/16 x 6"  
3/8 x 10"

3/16 x 3"  
3/16 x 6"

- Supplied in convenient blow mould tray



**Slot – Square Shank**

PROD. NO.	MOD. NO.	Size
720354	SDS-4S	1/4 x 4"
720356	SDS-6S	5/16 x 6"
720360	SDS-10S	3/8 x 10"
720362	SDS-12S	3/8 x 12"
720392	SDS-2SS	1/4 x 1-1/2" (Stubby)



**Slot – Round Shank**

PROD. NO.	MOD. NO.	Size
720363	SDS-3R	3/16 x 3"
720366	SDS-6R	3/16 x 6"



**Phillips – Round Shank**

PROD. NO.	MOD. NO.	Size
720371	SDP-1	#1 x 3"
720372	SDP-2	#2 x 4"
720373	SDP-3	#3 x 6"
720382	SDP-2S	#2 x 1-1/2" (Stubby)



**Square – Round Shank**

PROD. NO.	MOD. NO.	Size
721361	SDR-1	#1 x 4"
721362	SDR-2	#2 x 5"
721363	SDR-3	#3 x 6"
721372	SDR-2S	#2 x 1-1/2" (Stubby)



**TORX® – Round Shank**

PROD. NO.	MOD. NO.	Size
720911	SDT-10	T10 x 4"
720917	SDT-15	T15 x 4"
720922	SDT-20	T20 x 4"
720925	SDT-25	T25 x 4"
720929	SDT-27	T27 x 4"
720932	SDT-30	T30 x 4"







## TORQUE DRIVE®



720508

## TORQUE DRIVE® SERIES – SETS

- JET's Exclusive TORQUE DRIVE® cushion grip ergonomic handle design guarantees maximum torque and unparalleled user comfort increasing performance and productivity
- Black hardened magnetic tips eliminate chrome plating chipping off the tip (common on other brands); holds the screw to the screwdriver and ensures maximum durability and life
- Shafts made of the highest quality Chrome Vanadium steel for long life and maximum durability
- "Go thru" design offers a one piece Chrome Vanadium steel for long life and maximum durability
- All items meet U.S. Specifications GGG-S-121E and Canadian Government specifications CDA39-GP-17C

### 6 PC Basic Set

720508 / TDSS-6

Slot Phillips Square 1/4 x 4"  
5/16 x 6"#1 x 4"  
#2 x 4"#1 x 4"  
#2 x 4"

CrV

- JET's Exclusive TORQUE DRIVE® cushion grip ergonomic handle design guarantees maximum torque and unparalleled user comfort increasing performance and productivity
- Black hardened magnetic tips eliminate chrome plating chipping off the tip, holds the screw to the screwdriver and ensures maximum durability and life
- Shafts made of the highest quality Chrome Vanadium steel for long life and maximum durability
- "Go thru" design offers a one piece metal shaft from handle to tip
- All items meet U.S. Specifications GGG-S-121E and Canadian Government specifications CDA39-GP-17C

## TORQUE DRIVE®



### Slot – Round Shank

PROD. NO.	MOD. NO.	Size
720404	TDS-4	1/4 X 4"
720406	TDS-6	5/16 x 6"
720444	TDS-4N	3/16 x 4"
720446	TDS-6N	3/16 x 6"



CrV

### Phillips – Round Shank

PROD. NO.	MOD. NO.	Size
720421	TDS-1P	#1 x 4"
720422	TDS-2P	#2 x 4"
720423	TDS-3P	#3 x 6"



CrV

### Square – Round Shank

PROD. NO.	MOD. NO.	Size
720431	TDS-1R	#1 x 4"
720432	TDS-2R	#2 x 4"
720433	TDS-3R	#3 x 6"



CrV



## ERGONOMIC SCREWDRIVERS – SETS

- Unique handle design conforms to the hand for exceptional comfort and grip
- Co-moulded Polypropylene (PP) and Thermoplastic Vulcanizates (TPV) ensure maximum strength balanced with superior non-slip grip
- Resistant to most chemicals, solvents, and oil
- Pentagon shaped neck bolster minimizes roll away
- Tip size and style on handle end for easy identification in tool pouch
- Patented SVCM tool steel is up to 30% stronger than CrV screwdrivers
- Phosphate plated tip will not chip or peel
- Meets ANSI specifications



720523



720524



720527

### 9 PC Ergonomic Screwdriver Set

720523 / JSTD-9S

Slot

Phillips

Square

3/16 x 3"  
1/4 x 4"  
5/16 x 6"

#1 x 3"  
#2 x 4"  
#3 x 6"

#1 x 4"  
#2 x 4"  
#3 x 4"

SVCM

### 14 PC Ergonomic Screwdriver Set

720524 / JSTD-14S

Slot

Phillips

Square

3/16 x 3"  
3/16 x 6"  
1/4 x 1-1/2"  
1/4 x 4"  
5/16 x 6"  
3/8 x 8"

#1 x 3"  
#2 x 1-1/2"  
#2 x 4"  
#3 x 6"

#1 x 4"  
#2 x 1-1/2"  
#2 x 4"  
#3 x 4"

SVCM

### 7 PC Ergonomic TORX® Driver Set

720527 / JSTD-7TS

TORX®

T10 x 4", T15 x 4", T20 x 4", T25 x 4", T27 x 4", T30 x 4", T40 x 4"

SVCM

## Cabinet Tip Slot

PROD. NO.	MOD. NO.	Size
720812	JTCS-3	3/16 x 3"
720813	JTCS-6	3/16 x 6"



SVCM

## Keystone Tip Slot

720814	JTSS-2	1/4 x 1-1/2"
720815	JTSS-4	1/4 x 4"
720817	JTSS-6	5/16 x 6"
720818	JTSS-8	3/8 x 8"



SVCM

## Phillips

720821	JTPH-1	#1 x 3"
720823	JTPH-2S	#2 x 1-1/2"
720824	JTPH-2	#2 x 4"
720827	JTPH-3	#3 x 6"



SVCM

## Square

720832	JTSR-1	#1 x 4"
720834	JTSR-2S	#2 x 1-1/2"
720835	JTSR-2	#2 x 4"
720837	JTSR-3	#3 x 4"



SVCM

## TORX®

720841	JTST-10	T10 x 4"
720842	JTST-15	T15 x 4"
720843	JTST-20	T20 x 4"
720844	JTST-25	T25 x 4"
720845	JTST-27	T27 x 4"
720846	JTST-30	T30 x 4"
720848	JTST-40	T40 x 4"



SVCM



720844



720812



720823



720835





## CUSHION GRIP SCREWDRIVERS – SETS

- Patented SVCM tool steel is up to 30% stronger than CrV screwdrivers
- Hardened and tempered for superior strength and improved durability
- Super strong acetate handles resist impact and chemicals
- Integrated cushion grips provide all day comfort and increased torque
- Chrome plated for superior corrosion resistance
- Precision machined phosphate plated tips for superior fit in all screw head types
- Tip type permanently engraved on handle ends for easy identification in tool pouch



720560

### 4 PC Cushion Grip Mini Screwdriver Set

720560 / JKS-4SM

Slot - Round Shank

Phillips

1/16" x 3"  
3/32" x 3"  
1/8" x 3"

#0 x 3"

SVCM



720562

### 4 PC Extra Long Cushion Grip Screwdriver Set

720562 / JKS-4SL

Slot - Round Shank

Phillips

Square

3/8" x 10"  
3/8" x 12"

#2 x 10"

#2 x 8"

SVCM



720564

### 9 PC Cushion Grip Screwdriver Set

720564 / JKS-9S

Slot - Square Shank

Phillips

Square

3/16" x 3"  
1/4" x 4"  
5/16" x 6"

#1 x 3"  
#2 x 4"  
#3 x 6"

#1 x 4"  
#2 x 4"  
#3 x 4"

SVCM



720566

### 14 PC Cushion Grip Screwdriver Set

720566 / JKS-14S

Slot - Square Shank

Slot Stubby Round Shank

Cabinet Tip

Phillips

Square

1/4" x 4"  
5/16" x 6"  
3/8" x 8"

1/4" x 1-1/2"

3/16" x 3"  
3/16" x 6"

#1 x 3"  
#2 x 1-1/2"  
#2 x 4"  
#3 x 6"

#1 x 4"  
#2 x 1-1/2"  
#2 x 4"  
#3 x 4"

SVCM



## Miniature – Slot/Phillips – Round Shank

PROD. NO.	MOD. NO.	Size
720605	JKMS-116	1/16" x 3"
720606	JKMS-332	3/32" x 3"
720607	JKMS-18	1/8" x 3"
720641	JKMP-0	PH#0 x 3"



SVCM



## Slot – Square Shank

720612	JKSS-4	1/4" x 4"
720613	JKSS-6	5/16" x 6"
720616	JKSS-8	3/8" x 8"



SVCM



## Slot – Round Shank

720621	JKSS-2RS	1/4" x 1-1/2"
720622	JKSS-4R	1/4" x 4"
720623	JKSS-6R	5/16" x 6"
720626	JKSS-8R	3/8" x 8"
720627	JKSS-10R	3/8" x 10"
720628	JKSS-12R	3/8" x 12"



SVCM



## Cabinet Tip – Round Shank

720632	JKSS-3CT	3/16" x 3"
720633	JKSS-4CT	3/16" x 4"
720634	JKSS-6CT	3/16" x 6"
720635	JKSS-8CT	3/16" x 8"



SVCM



## Phillips – Round Shank

720642	JKSP-1	PH1 x 3"
720644	JKSP-2S	PH2 x 1-1/2"
720646	JKSP-2	PH2 x 4"
720648	JKSP-2L	PH2 x 10"
720649	JKSP-3	PH3 x 6"



SVCM



## Square – Round Shank

720653	JKSR-1	R1 x 4"
720654	JKSR-2S	R2 x 1-1/2"
720656	JKSR-2	R2 x 4"
720658	JKSR-2L	R2 x 8"
720659	JKSR-3	R3 x 4"



SVCM





Replacement Bits - See page 343

## CUSHION GRIP MULTI-BIT DRIVERS - SETS

- Super strong acetate handle resists impact and chemicals
- Integrated cushion grip provides all day comfort and increased torque
- Chrome plated for superior corrosion resistance
- Double ended bits for maximum versatility with minimal pieces
- Can be used as a nut driver with bits removed

### 5-in-1 Cushion Grip Multi-Bit Screwdriver 720531 / JKMD-5S

Slot 	Phillips 	Square 	Nut 
3/16 & 1/4"	#2	#2	1/4"

### 6-in-1 Cushion Grip Multi-Bit Screwdriver 720533 / JKMD-6

Slot 	Phillips 	Square 	Nut 
3/16 & 1/4"	#2	#2	1/4" & 5/16"

### 10-in-1 Cushion Grip Multi-Bit Screwdriver 720534 / JKMD-10

Slot 	Phillips 	Square 	Nut 
3/16 & 1/4"	#1, #2, #3	#1, #2, #3	1/4" & 5/16"

## MULTI-BIT DRIVERS

### 15-In-1 Multi-Bit Screwdriver H3400



**Distributors please note:** Drivers are sold in 6 pack POP display only.

- Features a patented pullout bit cartridge
- 15-in-1 multi-bit screwdriver replaces 14 of the most popular bits and 14 screwdrivers and a 1/4" hex nut drive
- 2" double end bits are made of superior quality S2 steel for strength and durability
- Shaft is made of super high strength 12T14 steel for long life
- End of shaft is a 1/4" hex nut drive
- Handle is made of durable nylon reinforced Triax® resin for longest life
- Unique rotating cap design allows you to position the cap in the palm of your hand and rotate the driver handle with your fingers. The driver then acts like a gearless ratcheting screwdriver increasing productivity while reducing blisters and operator fatigue
- Drivers are easy to use from both the left and right sides allowing you to use them in tight confined areas
- Collar also swivels 360° for fast efficient driving of screws
- Made in the U.S.A.





## 19-in-1 Multi-Bit Screwdriver

720590 / JRSD-19

- 19-in-1 screwdriver features 8 double ended bits and 3 nut driver sizes
- Heavy duty reversible 25 tooth ratchet with centre lock position
- Ergonomic handle for comfort and secure grip
- Bits store in handle
- Available in 12 piece POP display



### 8 1/4" Double-Ended Bits

	&			&S	
	&			&T	
	&			&T	
	&			&3	



Replacement Bits - See page 343



720590

**Distributors please note:** Drivers are sold in 12 pack POP display only.



## RATCHETING DRIVERS

- 45 tooth all steel ratchet mechanism provides high torque and smooth operation
- Lifetime tested to 50,000 cycles
- Soft textured handle provides excellent grip
- Chrome Vanadium steel shaft with powerful bit holder magnet

### Convertible Pistol Grip Ratcheting Screwdriver

720551 / JPRSD-9

- Spring loaded cartridge in handle pops out with a simple squeeze of the recessed buttons and holds 6 bits on board
- Complete with 6 nickel plated S2 bits and 1/4" socket drive adapter
- Can be used with any 1/4" hex drive bits for easy customizing of bit load
- Available in 12 piece POP display
- Replacement Bit Cartridge (**720559**)



3 position switch for left and right ratcheting or non-ratcheting use



Bits



Shafts



#### Bit Load

5.5, 6.5 mm Slot  
#1, #2 Phillips  
#1, #2 Square  
1/4" Socket Adapter



Bit storage cartridge concealed in handle



Unique 2-way handle converts from straight to pistol grip for increased torque



## Convertible Pistol Grip Ratcheting Screwdriver

720552 / JRSD-9S

- Stubby handle for work in confined spaces
- 3 position switch for left and right ratcheting or non-ratcheting use
- Complete with 6 nickel plated S2 bits and 1/4" socket drive adapter
- Can be used with any 1/4" hex drive bits for easy customizing of bit load
- Available in 12 piece POP display



### Bit Load

- 5.5, 6.5 mm slot
- #1 #2 Phillips
- #1 #2 Square
- 1/4" socket adapter

Complete with 6 nickel plated S2 bits and 1/4" socket drive adapter



Bits



Shafts

Stubby handle for work in confined spaces



3 position switch for left and right ratcheting or non-ratcheting use

## T-Handle Ratcheting Screwdriver

720556 / JTRSD-21

- Includes interchangeable 2" and 4" shafts for added versatility
- Can be used with any 1/4" hex drive bits for easy customizing of bit load
- Available in 12 piece POP display

Complete with 17 nickel plated S2 bits and 1/4" socket drive adapter



Bits



Shafts

Comfortable T-Handle provides excellent grip and transfer of power



3 position switch for left and right ratcheting or non-ratcheting use



### Bit Load

- 4.0, 5.5, 6.5 mm slot
- #1, #2, #3 Phillips
- #1, #2, #3 Square
- T10, T15, T20, T25, T27 TORX\*
- 3, 4, 5 mm Hex
- 1/4" Socket Adapter





## INSERT BITS



Available in various package quantities to suit any need



- A2 Steel bits are dual heat treated for greatly increased tensile strength
- Allows for more consistent edges and up to 50% greater life than S2 bits
- Heat treated to HRC 58-62
- 1" overall length
- For use with standard or quick release 1/4" hex bit holders
- Canada's strongest and longest lasting bits

### Slot

PROD. NO. Tip Size Length Pieces

729112	5/32"	1"	2
729114	5/32"	1"	20
729119	1/4"	1"	2
729121	1/4"	1"	20



### Phillips

PROD. NO. Tip Size Length Pieces

729009	PH1	1"	2
729011	PH1	1"	20
729025	PH2	1"	2
729027	PH2	1"	20
729028	PH2	1"	50
729042	PH3	1"	2
729044	PH3	1"	20



### Square

PROD. NO. Tip Size Length Pieces

729061	R1	1"	2
729063	R1	1"	20
729078	R2	1"	2
729080	R2	1"	20
729081	R2	1"	50
729095	R3	1"	2
729097	R3	1"	20



### Hex

PROD. NO. Tip Size Length Pieces

729303	1/8"	1"	2
729317	5/32"	1"	2
729324	3/16"	1"	2
729331	7/32"	1"	2
729338	1/4"	1"	2
729366	3 mm	1"	2
729373	4 mm	1"	2
729380	5 mm	1"	2
729394	6 mm	1"	2



### Magnetic Bit Holders

- For use with insert bits or to extend the reach of power bits
- Powerful magnet holds bit in any position
- Quick release model locks bit in place until ejected

PROD. NO.	MOD. NO.	Type
729483	JMBH-60	Magnetic
729484	JQBH-65	Quick Release Magnetic



### TORX

PROD. NO. Tip Size Length Pieces

729163	T8	1"	2
729166	T10	1"	2
729173	T15	1"	2
729180	T20	1"	2
729187	T25	1"	2
729194	T27	1"	2
729201	T30	1"	2
729208	T40	1"	2



- A2 Steel bits are dual heat treated for greatly increased tensile strength
- Allows for more consistent edges and up to 50% greater life than S2 bits
- Heat treated to HRC 58-62
- Available in various package quantities and lengths to suit any need
- 1/4" hex shaft fits ball retainer and regular style chucks
- Canada's strongest and longest lasting bits

**Slot**

PROD. NO.	Tip Size	Length	Pieces
729115	5/32"	2"	2
729117	5/32"	2"	10
729122	1/4"	2"	2
729124	1/4"	2"	10

**A2**



**Phillips**

PROD. NO.	Tip Size	Length	Pieces
729013	PH1	2"	2
729015	PH1	2"	10
729018	PH1	2-3/4"	2
729020	PH1	2-3/4"	10
729022	PH1	6"	1
729029	PH2	2"	2
729031	PH2	2"	10
729032	PH2	2"	25
729034	PH2	2-3/4"	2
729036	PH2	2-3/4"	10
729039	PH2	6"	1
729040	PH2	6"	10
729046	PH3	2"	2
729048	PH3	2"	10
729051	PH3	2-3/4"	2
729056	PH3	6"	1

**A2**



**Square**

PROD. NO.	Tip Size	Length	Pieces
729065	R1	2"	2
729067	R1	2"	10
729070	R1	2-3/4"	2
729072	R1	2-3/4"	10
729075	R1	6"	1
729082	R2	2"	2
729084	R2	2"	10
729085	R2	2"	25
729087	R2	2-3/4"	2
729089	R2	2-3/4"	10
729092	R2	6"	1
729093	R2	6"	10
729099	R3	2"	2
729101	R3	2"	10
729104	R3	2-3/4"	2
729109	R3	6"	1

**A2**



**Hex**

PROD. NO.	Tip Size	Length	Pieces
729306	1/8"	2"	2
729320	5/32"	2"	2
729327	3/16"	2"	2
729334	7/32"	2"	2
729341	1/4"	2"	2
729369	3 mm	2"	2
729376	4 mm	2"	2
729383	5 mm	2"	2
729397	6 mm	2"	2

**A2**



**TORX**

PROD. NO.	Tip Size	Length	Pieces
729169	T10	2"	2
729176	T15	2"	2
729183	T20	2"	2
729190	T25	2"	2
729197	T27	2"	2
729204	T30	2"	2
729211	T40	2"	2

**A2**



**A2** **50%**  
STRONGER THAN S2

**IMPACT RATED**

**NUTSETTERS**

- Powerful magnet holds fastener securely for use in any position
- Heat treated Chrome Vanadium steel for professional use
- 1/4" hex shaft fits ball retainer and regular style chucks



**SAE CrV Steel**

PROD. NO.	Tip Size	Pieces
729461	1/4"	1
729462	5/16"	1
729463	3/8"	1

**CrV**

**Metric CrV Steel**

PROD. NO.	Tip Size	Pieces
729471	6 mm	1
729472	7 mm	1
729473	8 mm	1
729475	10 mm	1

**CrV**



Hollow shafts allow running nuts on long fasteners



## CUSHION GRIP NUT DRIVERS - SETS

- Chrome Vanadium steel for professional use
- Hardened and tempered for superior strength and improved durability
- Super strong acetate handles resist impact and chemicals
- Integrated cushion grips provide all day comfort and increased torque
- Chrome plated for superior corrosion resistance
- Hex bolster allows use of a wrench for increased torque
- Hollow shaft fits over long fasteners
- Socket size permanently embossed on handles for easy identification in tool pouch
- Convenient plastic carrying case keeps nut drivers organized

### 7 PC SAE Cushion Grip Nut Driver Set

721101 / JKND-7S

3/16", 1/4", 5/16", 11/32", 3/8", 7/16", 1/2"



### 7 PC Metric Cushion Grip Nut Driver Set

721102 / JKND-7M

6, 7, 8, 9, 10, 11, 12 mm



## CUSHION GRIP NUT DRIVERS - OPEN STOCK

SAE		Metric	
PROD. NO.	Size	PROD. NO.	Size
721141	3/16" x 3	721151	6 mm x 3
721142	1/4" x 3	721152	7 mm x 3
721143	5/16" x 3	721153	8 mm x 3
721144	11/32" x 3	721154	9 mm x 3
721145	3/8" x 3	721155	10 mm x 3
721146	7/16" x 3	721156	11 mm x 3
721147	1/2" x 3	721157	12 mm x 3





721111

## JUMBO HANDLE SERIES - SET

- Jumbo grip grooved handle design ensures maximum torque for tough jobs
- Made with super acetates, these handles are virtually indestructible
- Hollow Chrome Vanadium shafts

### 7 PC SAE - Hollow Shaft

721105 / NDS-07

**3/16, 1/4, 5/16, 11/32, 3/8, 7/16, 1/2"**

- Roll up pouch

**6 CrV**

721105

## JUMBO HANDLE SERIES - OPEN STOCK

### SAE - Hollow Shaft

PROD. NO.	MOD. NO.	Size	Length	Point
721111	ND-316	<b>3/16"</b>	3-1/2"	6
721112	ND-14	<b>1/4"</b>	3-1/2"	6
721113	ND-516	<b>5/16"</b>	3-1/2"	6
721114	ND-1132	<b>11/32"</b>	3-1/2"	6
721115	ND-38	<b>3/8"</b>	3-1/2"	6
721116	ND-716	<b>7/16"</b>	3-1/2"	6
721117	ND-12	<b>1/2"</b>	3-1/2"	6

**6 CrV**



720542



720546



## PRECISION SCREWDRIVER - SETS

- Ergonomic bi-material handles for sure grip
- Rotating cap allows easy one hand operation
- Chrome Vanadium steel shafts
- Convenient plastic case

### 6 PC Slot / Phillips Set

720542 / JPSP-6

Slot Phillips 

2.0, 3.0, 4.0

#00, #0, #1

CrV

### 6 PC TORX® Set

720546 / JPSP-6T

TORX® 

T5, T6, T7, T8, T9, T10

CrV

## IMPACT DRIVER

### 1/2" Drive

720702 / JID-5S

- Premium grade high carbon steel body withstands high impact forces
- Entirely heat treated for maximum strength
- S2 steel bits for professional use
- Drives 5/16" shank screwdriver bits and 1/2" drive impact sockets
- Reversible for installing or removing fasteners
- Ideal for removing rusted fasteners
- Includes 5/16" and 3/8" slot and #2 and #3 Phillips bits

Replacement 4 piece bit set **720791**



720702



**PLIERS  
CUTTERS  
SHEET METAL TOOLS**





## LOCKING PLIERS - OPEN STOCK

- Made of Chrome Molybdenum steel for added durability
- Heat treated handles, pins and jaws
- Nickel plated finish resists corrosion
- Strong locking mechanism with welded seams for strength under load
- Ergonomic cushioned release lever is guarded to prevent accidental release
- All locking pliers come with wire cutter in jaw
- Meets ANSI requirements



730338

### 5 PC Locking Pliers Set

PROD. NO.	MOD. NO.	Pieces	Length	Type
730338	JLPS-5	5	<b>5", 7", 10", 7", 9"</b>	Curved Jaw / 5", 7", 10" Long Nose / 7", 9"

CrMo

### Locking Pliers - Open Stock

PROD. NO.	MOD. NO.	Length	Type
730452	JLP-5C	<b>5"</b>	Curved Jaw
730454	JLP-7C	<b>7"</b>	Curved Jaw
730457	JLP-10C	<b>10"</b>	Curved Jaw
730464	JLP-7L	<b>7"</b>	Long Nose
730466	JLP-9L	<b>9"</b>	Long Nose

CrMo



Curved Jaw

Teeth raked to provide superior non-slip grip



- Exclusive 9254 steel jaw components offer increased core strength over Chrome Molybdenum or Chrome Vanadium jaws
- Jaw hardness increases below the surface allowing for increased clamping pressure and offering longer tooth life
- Precision ground jaws with backward raked teeth for superior grip
- All models complete with wire cutter
- Cushioned release lever is guarded to prevent accidental release
- Handles made of top quality Chrome Molybdenum steel – much stronger than carbon steel handles used on the leading brand
- Stronger handle steel prevents rivet holes from enlarging over time, leading to rivet failure
- Exceeds ANSI requirements and industry standards

Chrome Molybdenum steel handles



Exclusive 9254 Steel Jaw

**YOU CAN'T BUY A BETTER, STRONGER LOCKING PLIERS**



730336



730335

### Locking Pliers Sets - Super Heavy Duty

PROD. NO.	MOD. NO.	Pieces	Length	Type
730336	LPS-3	3	6", 7", 10"	Curved Jaw / 7", 10" Long Nose / 6"
730335	LPS-5	5	5", 7, 10", 6", 9"	Curved Jaw / 5", 7", 10" Long Nose / 6", 9"



### Locking Pliers - Open Stock

PROD. NO.	MOD. NO.	Length	Type
730453	J5WR	5"	Curved Jaw
730455	J7WR	7"	Curved Jaw
730456	J7WRG	7"	Curved Jaw / PVC Grip
730458	J10WR	10"	Curved Jaw
730459	J10WRG	10"	Curved Jaw / PVC Grip
730462	J4LN	4"	Long Nose
730463	J6LN	6"	Long Nose
730467	J9LN	9"	Long Nose



PVC Grip



Long Nose





730496

## LOCKING PLIERS - OPEN STOCK

### Chain Wrench

730496 / J20R

- 20" chain
- Made of industrial quality Chrome Molybdenum steel
- Strong locking mechanism
- Ergonomic cushioned release lever is guarded to prevent accidental release
- Meets ANSI requirements
- Quality equal to the best!

CrMo

730554, 730556  
C-Clamp730555, 730557  
C-Clamp with Pads730558  
Sheet Metal730559  
Welders

### Locking Clamps - Open Stock

- Chrome Vanadium and Chrome Molybdenum jaw components for improved strength
- C-Clamps available with your choice of plain tips or swivel pads
- New heavy duty material for improved performance and life

PROD. NO.	MOD. NO.	Length	Type
730554	J6R	6"	C-Clamp
730555	J6RP	6"	C-Clamp with Pads
730556	J11R	11"	C-Clamp
730557	J11RP	11"	C-Clamp with Pads
730558	J8R	8"	Sheet Metal
730559	J9R	9"	Welders

CrMo CrV



730555

## SNAP RING PLIERS - SETS

- Cushion grip handles
- Made of carbon steel
- Spring loaded handles



### 5 PC Interchangeable Tips

PROD. NO.	MOD. NO.	Length	Type
730352	SRP-1S	6"	Straight tips, Bent tips, Convertible type



730352

### 4 PC Permanent Tips

PROD. NO.	MOD. NO.	Length	Type
730353	SRP-4S	7"	Internal Straight, External Straight, Internal Bent, External Bent



730353

## SNAP RING PLIERS - OPEN STOCK

### Internal Type

PROD. NO.	MOD. NO.	Length	Type
730701	SRP-175IS	7"	Internal Straight
730702	SRP-175IB	7"	Internal Bent



730701

730702

### External Type

PROD. NO.	MOD. NO.	Length	Type
730703	SRP-175ES	7"	External Straight
730704	SRP-175EB	7"	External Bent



730703

730704





## CHROME VANADIUM - SETS

- Made of high quality Chrome Vanadium steel (except slip joint)
- Cutting edges induction hardened to HRC58-62
- Double-dipped cushion grip handles offer superior comfort, sure gripping action and long life



730311

### 4 PC Starter Pliers Set

730311 / JPS-4N

- 6-1/2" Diagonal Cutter
- 6-1/2" Long Nose
- 7" Lineman's
- 8" Slip Joint



730321

### 5 PC Maintenance Set

730321 / JPS-5

- 8" Long Nose
- 8" Diagonal Cutter
- 8" Lineman's
- 8" Slip Joint
- 8" Bent Nose



730341

### 5 PC Mechanics Pliers Set

730341 / JPS-5M

- 8" Angle Head Cutter
- 8" Long Nose
- 8" Lineman's
- 8" Slip Joint
- 10" Groove Joint



## CHROME VANADIUM - OPEN STOCK



- Made of high quality Chrome Vanadium steel (except Slip Joint)
- Cutting edges induction hardened to HRC58-62
- Double-dipped cushion grip handles offer superior comfort, sure gripping action and long life

### Slip Joint Pliers

- Made of quality Carbon steel

PROD. NO.	MOD. NO.	Length
730401	PL-6	6"
730402	PL-8	8"
730403	PL-10	10"



### Groove Joint Pliers

PROD. NO.	MOD. NO.	Length	Capacity
730441	CLP-1	7-1/2"	1-1/4"
730442	CLP-2	9-1/2"	1-3/4"
730443	CLP-3	12"	2-1/4"
730445	CLP-4	16"	4"



### Long Nose Pliers

PROD. NO.	MOD. NO.	Length
730423	RP-150	6-1/2"
730425	RP-200	8"



### Bent Nose Pliers

PROD. NO.	MOD. NO.	Length
730483	BP-150	6-1/2"
730485	BP-200	8"



## LONG REACH SERIES - OPEN STOCK

### Long Nose Style

PROD. NO.	MOD. NO.	Length	Type
730428	LRP-1100	11"	Long Nose
730488	LRP-1145	11"	Bent Nose



730401 - 730403



730442



730425



730483



730428

730488



730415



730433



730221

Angle head  
730221 only

730473



730232



735102

## CHROME VANADIUM - OPEN STOCK

### Lineman's Pliers

PROD. NO.	MOD. NO.	Length
730414	CP-175	7"
730415	CP-200	8"
730418	CP-250HD	9-3/4"

CrV

### Diagonal Cutting Pliers

- Unique shape and head configuration for best leverage and easiest cutting capabilities

PROD. NO.	MOD. NO.	Length	Type
730433	NP-150	6-1/2"	Diagonal Cutter
730435	NP-200	7-1/2"	Diagonal Cutter
730221	NPA-200HD	8"	Angle Head Cutter

CrV

### Crimping Pliers

730473 / WP-250HD

- 10" long
- A heavy duty cutter and crimping tool
- Not for use on live circuits

CrNi

### Box Joint Pliers

730232 / BJP-250HD

- 10" long
- Chrome Vanadium steel
- Special jaw design for use on pipe
- Unique box joint adjusting system allows quick and easy one hand adjustments

CrV

### 10" Fencing Pliers

735102 / FT-10X

- Drop forged steel with blue cushion grip handles
- Ideal multi-purpose pliers for farmers and ranchers
- Hammer, staple remover and 2 wire cutters in 1 tool
- Length 10"

**5 PC Chrome Nickel Pliers Set – Super Heavy Duty** 730305 / JPHD-5S

- Highest grade Chrome Nickel steel drop forged for ultimate strength
- Induction hardened teeth and exclusive laser hardened cutting edges for superior performance and long life
- Unique laser hardening process allows cutting of hardened materials including piano wire
- Patented high leverage design moves pivot point forward for increased cutting power and ease of use
- Handle springs on Lineman's, Diagonal Cutting, Bent Nose and Long Nose pliers open handles automatically, reducing fatigue and are easily removed if preferred
- Groove joint pliers feature undercut machined tongue and groove for greater strength at all jaw widths
- Right-angle teeth for superior grip
- Extra thick dual material handles provide unparalleled grip and user comfort
- Meets ANSI specifications

Induction Hardened Teeth

High Leverage Design  
Laser Hardened Cutting Edge  
Spring Loaded Handles  
Induction Hardened Teeth



Induction Hardened Teeth

**FEATURES**

**High Leverage Design**

Patented High Leverage design moves pivot point forward for increased cutting power and ease of use

**Laser Hardened Cutting Edge**

Unique laser hardening process allows cutting of hardened materials including piano wire

**Spring Loaded Handles**

Handle springs on Linemans, Diagonal Cutting, and Long Nose pliers open handles automatically, reducing fatigue. Easily removed if preferred

**Induction Hardened Teeth**

Induction hardened right angle teeth for superior performance and long life

High Leverage Design  
Laser Hardened Cutting Edge  
Spring Loaded Handles





730241



730246

## CHROME NICKEL SERIES - OPEN STOCK

### Lineman's Pliers

- Unique laser hardening process allows cutting of hardened materials including piano wire
- Right angle teeth induction hardened to HRC55~60 for maximum grip
- Spring loaded handles reduce fatigue; spring can be easily removed and replaced if preferred

PROD. NO.	MOD. NO.	Length
-----------	----------	--------

730236	CP-200HD	8"
--------	----------	----

CrNi

### Diagonal Cutting Pliers

- Unique laser hardening process allows cutting of hardened materials including piano wire
- Spring loaded handles reduce fatigue; spring can be easily removed and replaced if preferred

PROD. NO.	MOD. NO.	Length
-----------	----------	--------

730222	NP-180HD	7-1/4"
--------	----------	--------

CrNi

### Long Nose Pliers

- Unique laser hardening process allows cutting of hardened materials including piano wire
- Right angle teeth induction hardened to HRC55~60
- Spring loaded handles reduce fatigue; spring can be easily removed and replaced if preferred

PROD. NO.	MOD. NO.	Length
-----------	----------	--------

730241	RP-200HD	8"
--------	----------	----

CrNi

### Bent Nose Pliers

PROD. NO.	MOD. NO.	Length
-----------	----------	--------

730246	BP-200HD	8"
--------	----------	----

CrNi







## Groove Joint Pliers

- Features undercut machined tongue and groove for maximum strength at all jaw widths
- Right angle teeth induction hardened to HRC55~60 for maximum grip

PROD. NO.	MOD. NO.	Length
730216	CLP-1HD	8"
730217	CLP-2HD	10"
730218	CLP-3HD	12"

CrNi



730217



## Slip Joint Pliers

- Right angle teeth induction hardened to HRC55~60 for maximum grip

PROD. NO.	MOD. NO.	Length
730206	SJ-6HD	6"
730207	SJ-8HD	8"

CrNi



720206



## End Nipper Pliers

- Ideal for flush cutting and concrete work

PROD. NO.	MOD. NO.	Length
730227	EN-200HD	8"

CrNi



730227



## Cable Cutter

- For copper and aluminum cables only
- Maximum AWG 1 cable gauge

PROD. NO.	MOD. NO.	Length
730251	CC-200HD	8"

CrNi



730251





735252



735256



735275

## SHEARS - SUPER HEAVY DUTY

- Top grade Japanese stainless steel for professional applications.
- Designed for left or right hand use.
- Vacuum heat treated for superior cutting edge and long life.

### Multi-Purpose Shears - Super Heavy Duty

- Serrated blades prevent material from being pushed forward, making cutting easier and more accurate
- Hardened stainless steel nut and bolt for adjustable tension
- Dual material Polypropylene and Thermoplastic Rubber handles for strength and secure grip
- Suitable for cutting branches, dowels, cardboard, rope, cord, wire, and many other materials

PROD. NO.	MOD. NO.	Overall Length	Cutting Length	Type
735252	JMPS-145	5-3/4"	1-1/4"	Straight
735253	JMPS-190	7-1/2"	1-5/8"	Straight
735254	JMPS-190A	7-1/4"	1-5/8"	Angled
735255	JMPS-200	8"	2"	Straight
735256	JMPS-200A	8"	2"	Angled



### 8" Utility Shears - Super Heavy Duty

- High leverage design transmits power more efficiently for easier cutting
- Suitable for cutting thick cloth, upholstery, leather, rubber, vinyl, fabric, rope, cardboard, paper, poultry and many other materials
- Thermoplastic elastomer handles are tough, pliable, and comfortable to use

PROD. NO.	MOD. NO.	Overall Length	Cutting Length	Type
735275	JUS-200	8"	2-1/2"	Straight



- Top grade Japanese stainless steel for professional applications.
- Designed for left or right hand use.
- Vacuum heat treated for superior cutting edge and long life.

### Electrician's - Super Heavy Duty

- Hollow ground blades requires less cutting effort
- Serrated blade prevents material from being pushed forward, making cutting easier and more accurate
- Dedicated wire stripping notch
- Fibreglass reinforced nylon handles with thermoplastic rubber overmould for superior strength and grip
- Suitable for cutting soft cable, insulation, electrical tape, cable ties and many other materials

PROD. NO	MOD. NO.	Overall Length	Cutting Length	Wire Cutter Notch
735262	JECS-140	5-1/2"	1-5/8"	yes



### Kevlar® Shears - Super Heavy Duty

- Specially selected high carbon alloy steel for use on Kevlar® materials
- Cutting edges induction hardened to HV1200
- Hollow ground blades requires less cutting effort
- Serrated blade prevents material from being pushed forward, making cutting easier and more accurate
- Fibreglass reinforced nylon handles with thermoplastic rubber overmould for superior strength and grip
- Suitable for cutting Kevlar®, insulation materials, electrical tape, cable ties, and many other materials

PROD. NO	MOD. NO.	Overall Length	Cutting Length
735264	JECS-140K	5-1/2"	1-5/8"





## WIRE STRIPPERS AND CUTTERS



### Automatic Wire Stripper

730731 / JAWS-822

- One quick light squeeze strips wire up to a full 1" without nicking, cutting or fraying
- Automatic wire gripper holds wire centered in stripping hole
- Lever action offers stripping and insulation removal in one step
- Adjustable wire stop to ensure uniform, precise strip length
- Overall Length **7"**
- Stripping Capacity: **8, 10, 12, 14, 16, 18, 20, 22** AWG solid and stranded



### V-Groove Wire Stripper

730738 / JWVS-51024

- Hardened carbon steel with black oxide finish for corrosion resistance
- Quickly adjusts from **AWG 10 to 24**
- Spring loaded for easy one hand use
- Overall length **5-1/4"**
- Capacity: **10, 12, 14, 16, 18, 20, 22, 24** AWG solid and stranded



### Self-Adjusting Wire Stripper

730736 / JAWS-100

- Self adjusting stripper automatically applies correct pressure to strip insulation without nicking wire
- Fine adjustment insulation
- Can be used to strip several wires simultaneously
- Includes wire cutter
- Overall length **6-1/2"**



### Spring Loaded Strippers / Cutters

- All cutting and stripping surfaces are precision machined to produce clean, exacting results
- High carbon heat treated steel for long life
- Black oxide finish resists rust and corrosion
- All models feature holes for looping and serrated tips for pulling wire
- Strippers / cutters are spring loaded for easy one hand operation and have safety lock (except 730724)
- Multifunction tools cut, strip and crimp insulated and non-insulated terminals
- For use on copper and aluminum wire only

730725

730724

730711

PROD. NO.	MOD. NO.	Overall Length	Stripping Capacity	Crimping Capacity	Bolt Size & Thread
730711	JWCS-61020	6-1/4"	10, 12, 14, 16, 18, 20 AWG solid and stranded	N/A	N/A
730724	JMWS-81024	8-1/4"	8, 10, 12, 14, 16, 18, 20, 22 AWG solid 12, 14, 16, 18, 20, 22, 24, 26 AWG stranded	10-22 AWG	4-40, 5-40, 6-32, 8-32, 10-32, 10-24
730725	JMWS-9618	9"	6, 8, 10, 12, 14, 16 AWG solid 8, 10, 12, 13, 16, 18 AWG stranded	10-22 AWG	4-40, 5-40, 6-32, 8-32, 10-32, 10-24



INTRODUCING OUR  
**NEW KNIVES**



A CUT ABOVE.





## CUTTING TOOLS

**9 mm Snap-Off Utility Knife****840433** / JSBK-9

- Ergonomic over-mould rubber grip for added comfort and safety
- Slide lock blade advance holds securely for extended use
- Includes SK5 high carbon steel blade

**NEW****18 mm Snap-Off Utility Knife****840432** / JSBK-18

- Ergonomic over-mould rubber grip for added comfort and safety
- Slide lock blade advance holds securely for extended use
- Includes SK5 high carbon steel blade

**NEW****25 mm Jumbo Snap-Off Utility Knife****840431** / JSBK-25

- Ergonomic over-mould rubber grip for added comfort and safety
- Dial lock blade advance holds securely for extended use
- Integrated magnet for easy blade retrieval
- Includes one SK5 high carbon steel blade

**NEW**

**9 mm Auto-Load Snap-Off Utility Knife**

840442 / JALK-9

- Ergonomic non-slip rubber grip for added comfort and safety
- Easy to use slide-lock blade advance locks blade automatically
- Integrated blade storage ejects and reloads blades quickly
- Includes five SK5 high carbon steel blades

**NEW****18 mm Auto-Load Snap-Off Utility Knife**

840441 / JALK-18

- Ergonomic non-slip rubber grip for added comfort and safety
- Easy to use slide-lock blade advance locks blade height automatically
- Integrated blade storage ejects and reloads blades quickly
- Includes five SK5 high carbon steel blades

**NEW****Folding Utility Knife - Heavy Duty**

840411 / JFFK-100

- Durable all-metal construction for the toughest work environments
- Dual locking handle (open and closed) with integrated belt clip keeps user safe, and the knife stored securely
- Titanium coated SK5 steel blade resists corrosion and extends blade life

**NEW****Safety Box Cutter**

840401 / JSBC-100

- Features a tape punch that will not damage contents, and a shielded cutting wheel for plastic strapping
- Extremely lightweight, designed with comfortable rubber grip

**NEW**

## REPLACEMENT BLADES

PROD. NO.	MOD. NO.	DESCRIPTION	FOR PRODUCTS
840481	JFRB-10	<b>10 PC Utility Knife Blades</b>	840411, 840421, 840422
840482	JFRB-10T	<b>10 PC Titanium Coated Utility Knife Blades</b>	840411, 840421, 840422
840486	JFRB-50	<b>50 PC Utility Knife Blades</b>	840411, 840421, 840422
840488	JFRB-100	<b>100 PC Utility Knife Blades</b>	840411, 840421, 840422
840491	JSRB-2510	<b>10 PC - 25 mm Utility Knife Blades</b>	840431
840494	JSRB-910	<b>10 PC - 9 mm Utility Knife Blades</b>	840442, 840433
840497	JSRB-1850	<b>50 PC - 18 mm Utility Knife Blades</b>	840441, 840432



840481



840482



840488



840492



840486



840497

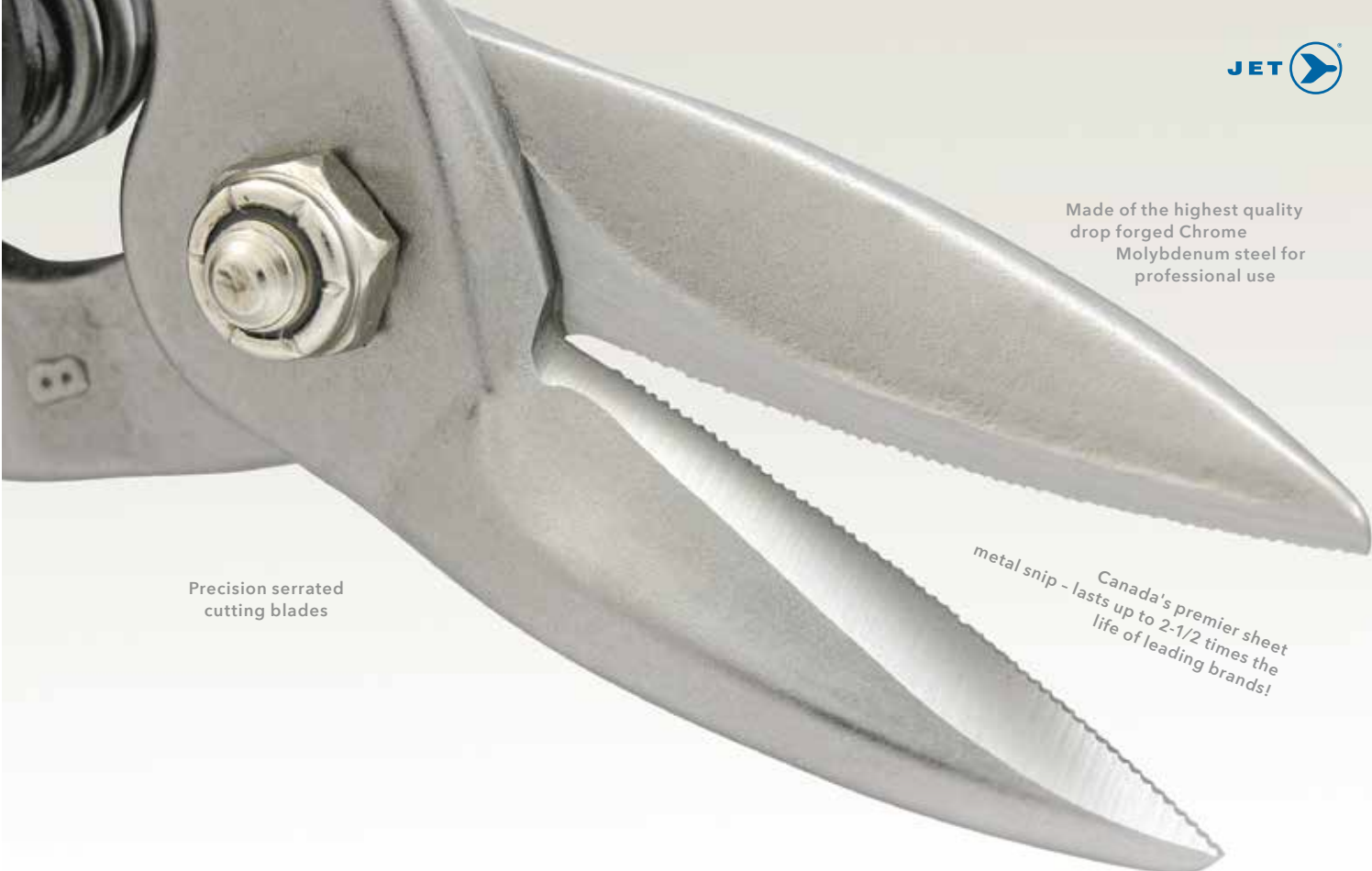

Precision serrated cutting blades

Made of the highest quality drop forged Chrome Molybdenum steel for professional use

Canada's premier sheet metal snip - lasts up to 2-1/2 times the life of leading brands!

## SHEET METAL TOOLS

### AVIATION SNIPS - SUPER HEAVY DUTY

- Made of the highest quality drop forged Chrome Molybdenum steel for professional use
- Induction hardened to HRC 60 – 62
- Serrated cutting edges prevent material from slipping out of blade
- Compound action reduces cutting effort
- Colour coded TPR handles provide maximum comfort
- Unique automatic release latch for easy one hand operation
- Regular, offset, notching and extra long models cover every application



735305

#### 3 PC Traditional Style Set

PROD. NO.	MOD. NO.	Description	Overall Length
735305	JAS-3S	Straight cut, Left cut and Right cut	10"



## Traditional Style - Open Stock

PROD. NO.	MOD. NO.	Description	Overall Length	Length to Cut	MAXIMUM MATERIAL THICKNESS (GAUGE)			
					Copper (soft)	Cold Rolled Steel (med.)	Hard Steel (HRC35)	304 Stainless Steel
735301	JAS-1S	<b>Straight</b>	<b>10"</b>	1-1/2"	16	18	21	22
735302	JAS-1R	<b>Right Cut</b>	<b>10"</b>	1-3/8"	16	18	21	22
735303	JAS-1L	<b>Left Cut</b>	<b>10"</b>	1-3/8"	16	18	21	22
735311	JAS-1SL	<b>Long Cut</b>	<b>11-3/8"</b>	3"	19	20	22	25
735391	JBS-1	<b>Bulldog</b>	<b>9"</b>	1"	14	16	18	18

CrMo



735303

735301

735302

735311

735391

735322

735323

## Offset Style - Open Stock

PROD. NO.	MOD. NO.	Description	Overall Length	Length to Cut	MAXIMUM MATERIAL THICKNESS (GAUGE)			
					Copper (soft)	Cold Rolled Steel (med.)	Hard Steel (HRC35)	304 Stainless Steel
735322	JOS-1R	<b>Right Cut</b>	<b>9-1/4"</b>	1-3/16"	16	18	21	22
735323	JOS-1L	<b>Left Cut</b>	<b>9-1/4"</b>	1-3/16"	16	18	21	22

CrMo

## 10" Tin Snip

735210 / JTS-10

- Made of drop forged high carbon steel
- One piece solid steel construction
- Smooth finished blades for cleaner cutting

Overall Length	Length to Cut	MAXIMUM MATERIAL THICKNESS (GAUGE)			
		Copper (soft)	Cold Rolled Steel (med.)	Hard Steel (HRC35)	304 Stainless Steel
<b>10"</b>	<b>2"</b>	20	22	24	26





## RIVET TOOLS

- Designed for industrial use
- All steel construction
- All models designed for use with aluminum rivets
- 859044 (JRT-707) for use with aluminum and steel rivets
- 859043 (JRT-736) features 360° swivel head

### Hand Riveters - Heavy Duty

PROD. NO.	MOD. NO.	Description	Nozzles	Length (Overall)
859042	JRT-200	Long Nose	3/32, 1/8, 5/32, 3/16"	—
859043	JRT-736	Swivel Head 360°	3/32, 1/8, 5/32, 3/16"	—
859044	JRT-707	Long Reach, use with aluminum and steel rivets	1/8, 5/32, 3/16, 7/32, 1/4"	21"
—	PUT-JRT707	Repair Kit	—	—

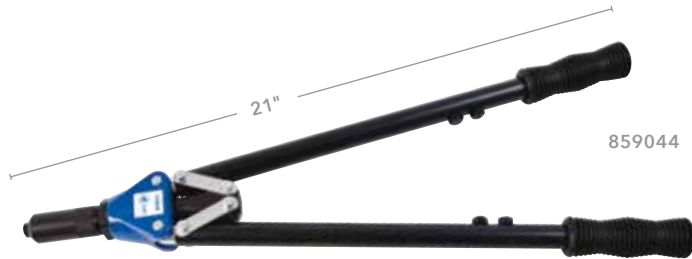

859042

859043



**Did you Know?**  
JET Carries a complete line of professional pneumatic rivet guns. See our AIR TOOLS section for details







# VDE TOOLS





## VDE TOOLS

- Electrically shielded tools for use on live circuits
- Individually tested and VDE certified to 1,000 V for maximum user protection
- Co-moulded polypropylene and thermoplastic vulcanizates ensure maximum strength balanced with superior non-slip grip
- Resistant to most chemicals, solvents, and oil
- Use on service panels, switch boxes, electric and hybrid automobiles, or anytime work must be performed while circuit is potentially live
- All items meet IEC60900:2004 standards

### VDE TOOL KITS

#### 10 PC Tool Kit

760002 / JITK-10S

- Contains most commonly used VDE screwdrivers and pliers
- Includes case



PROD. NO.	MOD. NO.	Includes
760213	JISS-5	7/32" x 5" Slot
760214	JISS-6	1/4" x 6" Slot
760236	JISR-2	#2 Square
760224	JISP-1	#1 Phillips
760226	JISP-2	#2 Phillips
760341	JIWS-6	6" Wire Stripper
760312	JILP-8	8" Lineman's Pliers
760322	JILN-8	8" Long Nose Pliers
760332	JINP-8	8" Diagonal Cutter
760352	JIWP-10	10" Water Pump Pliers

CrV

SVCM

## 9 PC Screwdriver Set

760202 / JISD-9S

- Includes pouch

PROD. NO.	MOD. NO	Includes
760211	JISS-4	5/32" x 4" Slot
760213	JISS-5	7/32" x 5" Slot
760214	JISS-6	1/4" x 6" Slot
760221	JISP-0	#0 Phillips
760224	JISP-1	#1 Phillips
760226	JISP-2	#2 Phillips
760228	JISP-3	#3 Phillips
760234	JISR-1	#1 Square
760236	JISR-2	#2 Square

SVCM

## 5 PC Nut Driver Set

770302 / JIND-5S

- Includes pouch

PROD. NO.	MOD. NO	Includes
760262	JIND-14	1/4" Nut Driver
760263	JIND-516	5/16" Nut Driver
760265	JIND-38	3/8" Nut Driver
760266	JIND-716	7/16" Nut Driver
760267	JIND-12	1/2" Nut Driver

CrV







## VDE SCREWDRIVERS - OPEN STOCK

- Two layers of insulation provide ultimate protection
- Unique handle design conforms to the hand for exceptional comfort and grip
- Pentagon shaped neck bolster minimizes roll away
- Tip size and style on handle ends for easy identification in tool pouch
- Patented SVCM tool steel is up to 30% stronger than CrV screwdrivers
- Phosphate plated tips will not chip or peel
- **Warning:** If yellow layer is exposed through the red layer, tool has been damaged and should be retired

### Slot Screwdrivers

PROD. NO.	MOD. NO.	Size
760211	JISS-4	5/32" x 4"
760213	JISS-5	7/32" x 5"
760214	JISS-6	1/4" x 6"



SVCM

### Phillips Screwdrivers

PROD. NO.	MOD. NO.	Size
760221	JISP-0	#0
760224	JISP-1	#1
760226	JISP-2	#2
760228	JISP-3	#3



SVCM

### Square Screwdrivers

PROD. NO.	MOD. NO.	Size
760234	JISR-1	#1
760236	JISR-2	#2



SVCM



760224

760213



- Two layers of insulation provide ultimate protection
- Unique handle design conforms to the hand for exceptional comfort and grip
- Pentagon shaped neck bolster minimizes roll away
- Size printed on handle ends for easy identification in tool pouch
- Chrome Vanadium steel for professional use
- **Warning:** If yellow layer is exposed through the red layer, tool has been damaged and should be retired

## Nut Drivers

PROD. NO.	MOD. NO.	Size
760262	JIND-14	1/4"
760263	JIND-516	5/16"
760265	JIND-38	3/8"
760266	JIND-716	7/16"
760267	JIND-12	1/2"



## VDE PLIERS AND CUTTERS - OPEN STOCK

- Drop forged Chrome Vanadium steel with induction hardened cutting edges
- Handle bolster for positive stop between insulated handle and non-insulated steel components

## Pliers and Cutters

PROD. NO.	MOD. NO.	Description
760341	JAWS-6	6" Wire Stripper
760312	JILP-8	8" Lineman's Pliers
760322	JILN-8	8" Long Nose Pliers
760332	JINP-8	8" Diagonal Cutter
760352	JIWP-10	10" Water Pump Pliers



760267





# PIPE TOOLS





710145



710245

## PIPE WRENCHES

### Steel - Heavy Duty

- Hardened Chrome Vanadium steel hook and heel jaws for professional applications
- Induction hardened teeth provide exceptional grip
- Powder coat paint for protection against corrosion
- Heel jaw attached with roll pin for easy replacement
- Meets US Federal Government Specification GGG-651 type II Class A

PROD. NO.	MOD. NO.	Length	Jaw Capacity
710142	JPW-8	8"	1"
710143	JPW-10	10"	1-1/2"
710144	JPW-12	12"	2"
710145	JPW-14	14"	2"
710147	JPW-18	18"	2-1/2"
710150	JPW-24	24"	3"
710156	JPW-36	36"	5"
710159	JPW-48	48"	6"

CrV

### Aluminum - Heavy Duty

- Hardened Chrome Vanadium steel hook and heel jaws for professional applications
- Induction hardened teeth provide exceptional grip
- Aluminum handle is up to 40% lighter than steel handles
- Heel jaw attached with roll pin for easy replacement
- Meets US Federal Government Specification GGG-651 type I Class B.10

PROD. NO.	MOD. NO.	Length	Jaw Capacity
710245	JPWA-14	14"	2"
710247	JPWA-18	18"	2-1/2"
710250	JPWA-24	24"	3"
710256	JPWA-36	36"	5"
710259	JPWA-48	48"	6"

CrV



## PIPE WRENCHES

### Steel - Super Heavy Duty

- Super Heavy duty cast steel handles for professional use
- Extra heavy cast head design is 20% stronger than competitive brands
- **Chrome Molybdenum** hook and heel jaws for longest life and maximum grip
- Jaws hardened to HRC 52 – 58
- Powder-coated for maximum resistance to corrosion
- Induction hardened teeth provide exceptional grip
- Heel jaws attached using roll pins for easy replacement
- Meets US Federal Government Specification GGG-651 type II Class A

PROD. NO.	MOD. NO.	Length	Jaw Capacity
710122	PW-8	8"	1-3/16"
710123	PW-10	10"	1-13/16"
710124	PW-12	12"	2-7/16"
710125	PW-14	14"	2-7/16"
710127	PW-18	18"	2-7/8"
710130	PW-24	24"	3-3/16"
710136	PW-36	36"	5-1/4"



### Aluminum - Super Heavy Duty

- Heavy duty lightweight aluminum handles for professional use
- Extra heavy duty cast head design is 20% stronger than competitive brands
- **Chrome Molybdenum** hook and heel jaws for longest life and maximum grip
- Jaws hardened to HRC 52 - 58
- Powder-coated for maximum resistance to corrosion
- Induction hardened teeth provide exceptional grip
- Heel jaws attached using roll pins for easy replacement
- Meets US Federal Government Specification GGG-651 type I Class B-10

PROD. NO.	MOD. NO.	Length	Jaw Capacity
710225	PWA-14	14"	2-7/16"
710227	PWA-18	18"	2-7/8"
710230	PWA-24	24"	3-3/16"
710236	PWA-36	36"	5-1/4"
710239	PWA-48	48"	6"



710124



710227



H1179



739109



Spare cutting wheel included

739102

Fold away deburring tool



Spare cutting wheel included

739104

## TUBE CUTTERS

### Mini Tube Cutters

- Compact overall size for use where space is restricted
- Cuts copper, brass, aluminum and thin wall steel conduit
- Hardened steel cutting wheel for copper cutting
- Replacement cutters: **739191** copper, **739193** stainless steel

PROD. NO.	MOD. NO.	Capacity	Replacement Cutters
H1179	-	<b>1/8" - 5/8" O.D.</b>	<b>739191</b> copper, <b>739193</b> stainless steel
739109	JMTC-30	<b>1/8" - 1-1/8" tubing</b> (3 - 30 mm)	<b>739192</b> copper, <b>739194</b> stainless steel

### 1-1/8" Screw Feed Tube Cutter

739102 / JTC-30

- Cuts copper, brass, aluminum and thin wall steel conduit
- Cuts **1/8" - 1-1/8"** (3 - 30 mm) tubing
- Grooved rollers allow cutting close to flare
- One piece sliding block for longest life and accurate cuts
- Includes fold away deburring tool
- Contoured adjustment knob houses spare cutting wheel
- Hardened steel cutting wheel for copper cutting
- Replacement cutters: **739191** copper, **739193** stainless steel

### Telescopic Tube Cutter

- Telescopic cutter requires no additional room to open to full capacity
- Cuts copper, brass, aluminum and thin wall steel conduit
- Grooved rollers allow cutting close to flare
- Hardened steel cutting wheel for copper cutting
- Includes spare cutting wheel for copper cutting

PROD. NO.	MOD. NO.	Capacity	Replacement Cutters
739104	JTTC-32	<b>1/8" - 1-1/4"</b>	<b>739191</b> copper, <b>739193</b> stainless steel

## TUBE CUTTERS



### 2" Quick Adjustable Tube Cutter

739107 / JOAC-50

- Spring loaded cutter wheel feed system allows slide action adjustment and quick release
- Cuts copper, brass, aluminum and thin wall steel conduit
- Cuts **1/4 – 2"** (6 – 50 mm) tubing
- Grooved rollers allow cutting close to flare
- Hardened steel cutting wheel for copper cutting
- Includes fold away deburring tool
- Contoured adjustment knob houses spare cutting wheel
- Replacement cutters: **739192** copper, **739194** stainless steel

Quick adjust slide action cutter arm

Spare cutting wheel included



### 1-1/8" Ratchet Tube Cutter

739108 / JRTC-28

- Ratchet action cutter allows cutting of tubes without having to rotate 360°
- Open end design is ideal for cutting sections of pipe in walls and other limited access areas
- Simply close cutter on tube and move back and forth until cut is made
- Cuts **5/16 – 1-1/8"** (8 – 29 mm) tubing
- Replacement cutters: **739192** copper, **739194** stainless steel



Ratchet mechanism rotates head 360° inside handle, allowing pipe cutting in confined spaces

## PIPE CUTTER

### 2" Iron Pipe Cutter

739111 / JPC-50

- Heavy duty drop forged steel body for demanding applications
- Ideally suited for cutting steel and iron pipes
- Can also be used on copper, brass, and aluminum tubing and thin wall conduit
- Cuts **1/8 – 2"** (3 – 50 mm) tubing
- Hardened steel cutting wheel
- Large ergonomic feed handle
- Replacement cutter: **739195**



## TUBE BENDER

### 3-in-1 Tube Bender

739142 / JTB-90

- Bends **1/4, 5/16, and 3/8"** soft tubing
- Compact design for use in confined areas
- Aluminum construction is rust proof
- Bends tubing smoothly without kinking or crushing
- Calibrated for quick reference





H.S.S. Blades



H.S.S. Blades

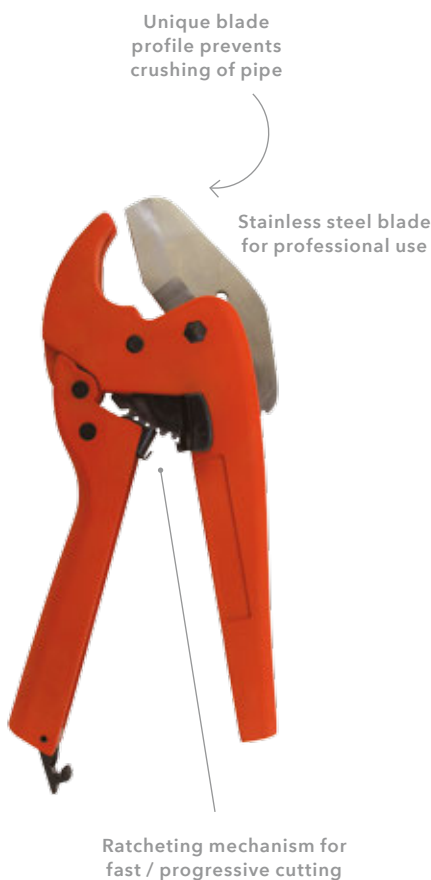

Unique blade profile prevents crushing of pipe

Stainless steel blade for professional use

Ratcheting mechanism for fast / progressive cutting

## DEBURRING TOOLS

### 6" Deburring Tool

739122 / JDT-100

- Large diameter contoured plastic handle
- High speed steel blades for cutting copper, brass, aluminum and stainless steel
- Spare blade is included and housed inside handle
- Push button blade release for fast blade changes
- Suitable for left and right hand cutting
- Overall length: 6"
- Replacement cutter: **739197**

### 6" Pocket Clip Deburring Tool

739125 / JDT-500

- Sleek aluminum body with pocket clip
- High speed steel blade for cutting copper, brass, aluminum and stainless steel
- Blade is easily replaceable
- Suitable for left and right hand cutting
- Overall length: 6"
- Replacement cutter: **739197**

## RATCHETING PVC PIPE CUTTER

### 1-5/8" PVC Pipe Cutter

739116 / JPPC-42

- Ratcheting action for easy progressive cutting
- Stainless steel blade
- Unique blade profile pierces pipe and prevents crushing
- Maximum capacity: 1-5/8" (42 mm)
- Replacement blade: **739198**

## For All Cutters

### Replacement Blades and Cutters

PROD. NO.	Application	Fits
739191	copper, brass, aluminum, steel	739109 (JMTC-30) 739102 (JTC-30) 739104 (JTTC-32)
739192	copper, brass, aluminum, steel	739105 (JTTC-42) 739107 (JQAC-50) 739108 (JRTC-28)
739193	stainless steel	739109 (JMTC-30) 739102 (JTC-30) 739104 (JTTC-32)
739194	stainless steel	739105 (JTTC-42) 739107 (JQAC-50) 739108 (JRTC-28)
739195	copper, brass, aluminum, steel, iron	739111 (JPC-50)
739197	copper, brass, aluminum, steel, iron, stainless steel	739122 (JDT-100) 739125 (JDT-500)
739198	PVC	739116 (JPPC-42)

## Flaring Tool

739132 / JFT-100

- Provides 45° flare or can be used with double flaring inserts
- Designed for use on **3/16, 1/4, 5/16, 3/8, 7/16, 1/2** and **5/8" tubing**
- Cast iron yoke
- Fully polished tubing clamp
- For soft copper, brass and aluminum tubing



## Flaring Tool - Heavy Duty

739133 / JFT-200

- Provides 45° flare or can be used with double flaring inserts
- Designed for use on **3/16, 1/4, 5/16, 3/8, 7/16, 1/2** and **5/8" tubing**
- Drop forged yoke and hardened steel tubing clamp for professional applications
- Ideal for automotive, HVAC, hydraulic and other heavy duty applications
- Can be used on copper, brass, aluminum and stainless steel tubing



## ISO Bubble Flaring Tool Kit

H1502

- Front wheel drive cars and light trucks, both foreign and domestic, are installing the ISO sized steel brake lines with the ISO flare. This is different from the standard double flare
- Accomplishes the ISO flare without removing the brake line from the vehicle, and has the strength to withstand the pressure necessary to flare mild steel tube (1.0 mm wall thickness) used on the front wheel drive brake line
- Yoke is made of a heat treated, alloy steel drop forging, with a special patented centre screw
- Bar assembly is hardened and will hold up under repeated use and produces a smooth, consistent flare
- Kit is complete with flaring tool, four special adapters, a chamfering tool and a combination wrench and height gauge

### Kit Includes:

- |  |                               |
|--|-------------------------------|
| • <b>H1502A</b> Adapter <b>4.75 mm</b> | • <b>H1502E</b> Bar Assembly  |
| • <b>H1502B</b> Adapter <b>6 mm</b>    | • <b>H1502F</b> Yoke Assembly |
| • <b>H1502C</b> Adapter <b>8 mm</b>    | • <b>H1502G</b> Reamer        |
| • <b>H1502D</b> Adapter <b>10 mm</b>   | • <b>H1502H</b> Wrench        |

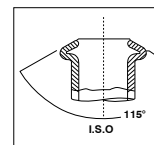



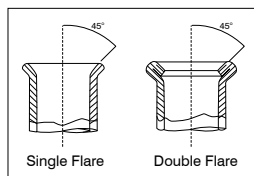

Kit includes tube cutter



## FLARING TOOLS

### Double Flaring Tool Kit - SAE

H1120

- Built to provide the necessary pressure to double flare steel brake tube
- Will double and single flare both copper and steel tube
- Double flare adapters provided for **3/16, 1/4, 5/16, 3/8 and 1/2"** tube
- Alloy steel swivel is heat-treated, ground, and chromed to reduce compression friction
- Yoke and bar is forged and tempered for added strength

#### Kit Includes:

<b>H1120A</b> Double Flare adapter <b>3/16"</b>	<b>H1120E</b> Double Flare adapter <b>1/2"</b>
<b>H1120B</b> Double Flare adapter <b>1/4"</b>	<b>H1120F</b> Bar Assembly
<b>H1120C</b> Double Flare adapter <b>5/16"</b>	<b>H1120G</b> Yoke and Bolt Assembly
<b>H1120D</b> Double Flare adapter <b>3/8"</b>	<b>H1120H</b> Wingnut

### Double Flaring Tool Kit - Metric

H1121

- Built to provide the necessary pressure to double flare steel brake tube
- Will double and single flare both copper and steel tube
- Double flare adapters provided for **3/16, 1/4, 5/16, 3/8 and 1/2"** tube
- Alloy steel swivel is heat-treated, ground, and chromed to reduce compression friction
- Yoke and bar is forged and tempered for added strength

#### Kit Includes:

<b>H1121A</b> Double Flare adapter <b>4.75 mm</b>	<b>H1121E</b> Double Flare adapter <b>10 mm</b>
<b>H1121B</b> Double Flare adapter <b>5 mm</b>	<b>H1121F</b> Bar Assembly
<b>H1121C</b> Double Flare adapter <b>6 mm</b>	<b>H1121G</b> Yoke and Bolt Assembly
<b>H1121D</b> Double Flare adapter <b>8 mm</b>	<b>H1120H</b> Wingnut

### Double Flaring and Cutting Tool Kit - SAE

739181 / JTFK-100

- Includes 739102 (JTC-30) Tubing Cutter, 739132 (JFT-100) Flaring Tool and Double Flaring Inserts for **3/16, 1/4, 5/16, 3/8, 7/16, 1/2 and 5/8"** tube
- Provides automotive type double flare or use without inserts for 45° flare
- Cuts up to 1-1/8" (30 mm) tube
- For soft copper, brass and aluminum tube
- Complete with blow mould storage case
- Replacement Double Flaring Dies:

<b>3/16" - H1120A</b>	<b>7/16" - H1120J</b>
<b>1/4" - H1120B</b>	<b>1/2" - H1120E</b>
<b>5/16" - H1120C</b>	<b>5/8" - H1120K</b>
<b>3/8" - H1120D</b>	



# STRIKING TOOLS





740307



740347



740348

## NAILING HAMMERS

### Hickory Handle - Heavy Duty

- American hickory handles
- Forged steel heads are hardened and tempered for professional use
- Meets ANSI specifications

PROD. NO.	MOD. NO.	Head Weight	Length (Overall)	Style
740307	CW16F	<b>16 oz</b>	13"	Claw

### Fibreglass Handle - Heavy Duty

- Highest fibreglass content for maximum strength
- Polymer jacketed to prevent splintering
- PVC grips for user comfort and safety
- Forged steel heads are hardened and tempered for professional use
- New improved bonding technology rated for use to -25°C
- Meets ANSI specifications

PROD. NO.	MOD. NO.	Head Weight	Length (Overall)	Style
740347	CF16F	<b>16 oz</b>	13"	Claw

### Fibreglass Handle - Super Heavy Duty

- Popular "California" style framing hammer
- 1045 medium carbon steel head hardened and tempered to prevent chipping or mushrooming
- Increased head weight designed to drive larger framing nails quickly
- Extra wide milled striking face reduces missed strikes
- Straight claws make removing nails easier
- Extra thick handle at head end for added strength and resistance to overstrikes
- Grips made of high quality thermoplastic elastomers for excellent comfort and non-slip use
- Meets ANSI specifications

PROD. NO.	MOD. NO.	Head Weight	Length (Overall)	Style
740348	CFH-21	<b>21 oz</b>	16-1/2"	Framing



## All Steel - Super Heavy Duty

- One piece steel handle is virtually immune to overstrikes
- 1055 medium carbon steel heads are hardened and tempered to prevent chipping or mushrooming
- Magnetic nail holder allows single hand use and accommodates different size nails (ripping hammer only)
- Milled face of ripping hammer minimizes slipping off the nail
- Claw hammer has smooth face for finishing work
- Grips made of high quality polypropylene and thermoplastic elastomers for excellent comfort and non-slip use
- Handle grip riveted to prevent separation
- Meets ANSI specifications

PROD. NO.	MOD. NO.	Head Weight	Length (Overall)	Style	Face
740321	CAS-16	<b>16 oz</b>	13"	Claw	Smooth
740331	RAS-22	<b>22 oz</b>	15-3/4"	Ripping	Milled



740331

## Anti-Shock All Steel - Super Heavy Duty

- One piece steel handle with "tuning fork" design absorbs and dissipates vibrations through the handle rather than transmitting them to the user's forearm and elbow
- Greatly reduces fatigue and stress
- 1055 medium carbon steel heads are hardened and tempered to prevent chipping or mushrooming
- Magnetic nail holder allows single hand use and accommodates different size nails
- D-face design allows nails to be driven when close to walls or other surfaces
- Milled face of ripping hammer minimizes slipping off the nail
- Claw hammer has smooth face for finishing work
- Grips made of high quality polypropylene and thermoplastic elastomers for excellent comfort and non-slip use
- Handle grips riveted to prevent separation
- Meets ANSI specifications

PROD. NO.	MOD. NO.	Head Weight	Length (Overall)	Style	Face
740381	CAV-16	<b>16 oz</b>	13"	Claw	Smooth
740386	RAV-20	<b>20 oz</b>	13-3/4"	Ripping	Milled



740381





740158



740166



740103

## BALL PEIN HAMMERS

### Hickory Handle - Heavy Duty

- American hickory handles
- Forged steel heads are hardened and tempered for professional use
- Meets ANSI specifications

PROD. NO.	MOD. NO.	Head Weight	Length (Overall)
740151	BP-8H	<b>8 oz</b>	11-1/2"
740153	BP-16H	<b>16 oz</b>	14"
740155	BP-24H	<b>24 oz</b>	15"
740157	BP-32H	<b>32 oz</b>	15"
740158	BP-40H	<b>40 oz</b>	15-3/4"

### Fibreglass Handle - Heavy Duty

- Highest fibreglass content for maximum strength
- Polymer jacketed to prevent splintering
- PVC grips for user comfort and safety
- Forged steel heads are hardened and tempered for professional use
- New improved bonding technology rated for use to -25°C
- Meets ANSI specifications

PROD. NO.	MOD. NO.	Head Weight	Length (Overall)
740161	BP-08F	<b>8 oz</b>	11"
740163	BP-16F	<b>16 oz</b>	13"
740164	BP-24F	<b>24 oz</b>	14-1/2"
740165	BP-32F	<b>32 oz</b>	15"
740166	BP-40F	<b>40 oz</b>	15-1/2"

### Steel Handle - Super Heavy Duty

- All steel handle is virtually immune to overstrikes
- 1055 medium carbon steel heads are hardened and tempered to prevent chipping or mushrooming
- Sand blast finish with fully polished striking faces
- TPR (Thermoplastic Rubber) handle grips absorb shock and provide excellent grip
- Handle grip riveted to prevent separation
- Meets ANSI specifications

PROD. NO.	MOD. NO.	Head Weight	Length (Overall)
740103	JSPB-16	<b>16 oz</b>	13"
740105	JSBP-24	<b>24 oz</b>	13-1/2"
740107	JSBP-32	<b>32 oz</b>	14-1/2"





## Indestructible Handle - Super Heavy Duty

- Spring steel rods encased in vulcanized rubber provide the ultimate striking tool handle
- Handle absorbs impact and vibration, reducing user fatigue
- Will not break, bend, or split even after repeated overstrikes
- Patented locking plate makes head separation impossible
- Provides unparalleled grip in all conditions and is resistant to most industrial chemicals
- Drop forged heads heat-treated to HRC 52-56
- Developed for the mining industry, these hammers are ideal for use in applications where a failure is more than just an inconvenience
- Lifetime Warranty
- Meets ANSI specifications

PROD. NO.	MOD. NO.	Head Weight	Product Weight	Length (Overall)
740174	UBP-2414	<b>24 oz</b>	<b>2.2 lb</b>	14"
740175	UBP-3214	<b>32 oz</b>	<b>2.7 lb</b>	14"
740176	UBP-4814	<b>48 oz</b>	<b>3.7 lb</b>	14"



## Deadblow - Super Heavy Duty

- One piece oven cured Polyurethane shell is much tougher than PVC, plastic, or rubber – up to 5 times the life
- Steel shot filled head directs full force of blow to the work, preventing rebound
- Precision tempered alloy steel striking face and ball pein hardened to HRC 48-54
- Beveled crown for accurate strikes
- Solid steel skeleton provides added strength and resists breaking on overstrike

PROD. NO.	MOD. NO.	Head Weight	Product Weight	Head Length	Face Diameter	Length (Overall)
740983	DBBP-16	<b>1 lb</b>	<b>16 oz</b>	4-1/4"	1-1/4"	12-3/4"
740984	DBBP-24	<b>1-1/2 lb</b>	<b>24 oz</b>	4-1/2"	1-1/2"	13"
740985	DPPB-32	<b>2 lb</b>	<b>32 oz</b>	4-7/8"	4-7/8"	16-1/4"



## CLUB HAMMER

- All steel handle is virtually immune to overstrikes
- 1055 medium carbon steel head hardened and tempered to prevent chipping or mushrooming
- Sand blast finish with fully polished striking faces
- TPR handle grip absorb shock and provide excellent grip
- Handle grip riveted to prevent separation
- Meets ANSI specifications

## Steel Club Hammer - Super Heavy Duty

PROD. NO.	MOD. NO.	Head Weight	Length (Overall)
740191	JSCH-25	<b>2-1/2 lb</b>	10-3/4"



STRIKING TOOLS  
**INDESTRUCTIBLE HANDLE**



740175



740983



740191



## STRIKING TOOLS

# INDESTRUCTIBLE HANDLE



### STEEL LOCKING PLATE

Makes head separation impossible

### HIGH VISIBILITY HEAD

Adds instant identification on any job site

### VULCANIZED RUBBER GRIP

Absorbs impact and vibration, reducing user fatigue; made from special grade ozone resistant rubber for use in tough environments

### DROP FORGED HEAD

With striking ends induction heat treated to HRC 52-56

### SPRING STEEL BARS

9/32" (7.1 mm) diameter spring steel bars resist overstrike without breaking

### TEXTURED NON-SLIP GRIP

### STEEL REINFORCED LANYARD HOLE



# INDESTRUCTIBLE HANDLE HAMMERS



- Spring steel rods encased in vulcanized rubber provide the ultimate striking tool handle
- Handle absorbs impact and vibration, reducing user fatigue
- Will not break, bend, or split even after repeated overstrikes
- Patented locking plate makes head separation impossible
- Provides unparalleled grip in all conditions and is resistant to most industrial chemicals
- Drop forged heads heat-treated to HRC 52-56
- Lifetime Warranty
- Meets ANSI specifications

## Steel Head

- Developed for the mining industry, these hammers are ideal for use in applications where a failure is more than just an inconvenience

PROD. NO.	MOD. NO.	Head Weight	Product Weight	Length (Overall)	Type
740174	UBP-2414	24 oz	2.2 lb	14"	Ball Pein
740175	UBP-3214	32 oz	2.7 lb	14"	Ball Pein
740176	UBP-4814	48 oz	3.7 lb	14"	Ball Pein
740178	UCP-216	2 lb	4.7 lb	16"	Cross Pein
740179	UCP-316	3 lb	5.7 lb	16"	Cross Pein
740580	USH-250	2.5 lb	3.85 lb	12"	Club
740581	USH-412	4 lb	5.50 lb	12"	Sledge
740582	USH-416	4 lb	5.8 lb	16"	Sledge
740593	USH-616	6 lb	8.7 lb	16"	Sledge
740583	USH-624	6 lb	9.1 lb	24"	Sledge
740584	USH-630	6 lb	10.0 lb	30"	Sledge
740585	USH-824	8 lb	11.1 lb	24"	Sledge
740586	USH-830	8 lb	12.0 lb	30"	Sledge
740596	USH-836	8 lb	13.0 lb	36"	Sledge
740587	USH-1030	10 lb	14.5 lb	30"	Sledge
740588	USH-1230	12 lb	16.5 lb	30"	Sledge
740598	USH-1236	12 lb	17.5 lb	36"	Sledge
740589	USH-1430	14 lb	18.5 lb	30"	Sledge



## Copper Head

- Heads drop forged from 99.9% pure copper for spark free use in explosive environments
- Softer copper heads will not mar struck objects
- Ideal for coal mining, oil and gas work and other potentially flammable or explosive applications

PROD. NO.	MOD. NO.	Head Weight	Product Weight	Length (Overall)	Type
740560	USH-250C	2-1/2 lb	3.75 lb	10-3/4"	Club
740565	USH-824C	8 lb	11.1 lb	24"	Sledge
740569	USH-1430C	14 lb	18.5 lb	30"	Sledge

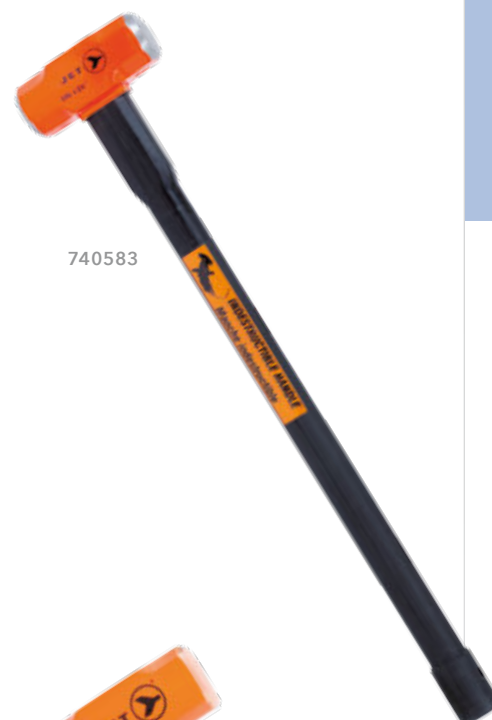



740522



740532



Smooth transition point between fiberglass and PVC handle for maximum comfort



740952

## SLEDGE HAMMERS

### Hickory Handle - Heavy Duty

- American hickory handles
- Forged steel heads are hardened and tempered for professional use
- Meets ANSI specifications

PROD. NO.	MOD. NO.	Product Weight	Length (Overall)
740522	SH-4H	<b>4 lb</b>	16"
740523	SH-6H	<b>6 lb</b>	32"
740524	SH-8H	<b>8 lb</b>	32"
740525	SH-10H	<b>10 lb</b>	32"
740526	SH-12H	<b>12 lb</b>	32"
740528	SH-16H	<b>16 lb</b>	36"

### Fibreglass Handle - Heavy Duty

- Highest fibreglass content for maximum strength
- Polymer jacketed to prevent splintering
- PVC grips for user comfort and safety
- Forged steel heads are hardened and tempered for professional use
- New improved bonding technology rated for use to -25°C
- Meets ANSI specifications

PROD. NO.	MOD. NO.	Product Weight	Length (Overall)
740532	SH-4F	<b>4 lb</b>	16"
740533	SH-6F	<b>6 lb</b>	30"
740534	SH-8F	<b>8 lb</b>	30"
740535	SH-10F	<b>10 lb</b>	36"
740536	SH-12F	<b>12 lb</b>	36"
740538	SH-16F	<b>16 lb</b>	36"

## DRILLING HAMMERS

### Fibreglass Handle - Heavy Duty

- Highest fibreglass content for maximum strength
- Polymer jacketed to prevent splintering
- PVC grips for user comfort and safety
- Forged steel heads are hardened and tempered for professional use
- New improved bonding technology rated for use to -25°C
- Meets ANSI specifications

PROD. NO.	MOD. NO.	Head Weight	Length (Overall)
740952	DH-48F	<b>3 lb</b>	10-1/2"
740953	DH-64F	<b>4 lb</b>	10-1/2"

## RUBBER MALLET



### Wooden Handle

PROD. NO.	MOD. NO.	Product Weight	Length (Overall)
740403	RM-16	<b>1 lb</b>	13-1/4"
740407	RM-32	<b>2 lb</b>	13-1/2"



740912

## WELDING HAMMER

### Chipping Hammer

740901/ FH-1

- Quickly removes welding flux



740901

## AXES AND MAULS

### Fibreglass Handle - Heavy Duty

- Highest fibreglass content for maximum strength
- Polymer jacketed to prevent splintering
- PVC grips for user comfort and safety
- Forged steel heads are hardened and tempered for professional use
- New improved bonding technology rated for use to -25°C

PROD. NO.	MOD. NO.	Head Weight	Length (Overall)	Type
741107	JH-150F	<b>1-1/2 lb</b>	16"	Hatchet
741121	JA-250F	<b>2-1/2 lb</b>	34"	Axe
741123	JA-350F	<b>3-1/2 lb</b>	34"	Axe
741141	SM-6F	<b>6 lb</b>	34"	Maul
741142	SM-8F	<b>8 lb</b>	34"	Maul



741107

741141

741121



**WARNING:** always wear safety goggles





740912



740926



740977

**5X** POLYURETHANE SHELL  
LIFE OF PVC

## SOFT FACE DEAD BLOW HAMMERS

### PVC Shell

- Single piece body made out of PVC, filled with steel shot
- Orange colour for high visibility

PROD. NO.	MOD. NO.	Head Weight	Length (Handle)
740912	DB-100	<b>1 lb</b>	11-1/2"
740913	DB-150	<b>1-1/2 lb</b>	12-1/2"
740914	DB-200	<b>2 lb</b>	13-1/2"
740915	DB-300	<b>3 lb</b>	16"

### Polyurethane / Fibreglass - Heavy Duty

- Polyurethane is much tougher and longer lasting than PVC – up to 5 times the life
- Steel shot filled head directs full force of blow to the work preventing rebound
- Soft face will not mar work
- Fibreglass handle with Polyurethane covered striking head
- TPR handle grip for superior control and user comfort
- Temperature range of -20°C to 90°C

PROD. NO.	MOD. NO.	Head Weight	Length (Overall)
740926	DB-400HD	<b>4 lb</b>	12"
740927	DB-600HD	<b>6 lb</b>	32"
740928	DB-800HD	<b>8 lb</b>	32"

### Polyurethane Shell - Super Heavy Duty

- One piece oven cured polyurethane shell is much tougher than PVC, plastic, or rubber – up to 5 times the life
- Superior resistance to cuts, splits, abrasions and many chemicals
- One piece seamless shell allows use in non-sparking environments
- Steel shot filled head directs full force of blow to the work, preventing rebound
- Soft face will not mar surfaces
- 6 lb and larger hammers feature flat head to allow hammer to stand upright
- Hardness Shore A 90 ±2

PROD. NO.	MOD. NO.	Head Weight	Head Length	Face Diameter	Length (Overall)
740971	DBHD-16	<b>1 lb</b>	3-1/2"	1-15/32"	11"
740972	DBHD-24	<b>1-1/2 lb</b>	4"	1-3/4"	12"
740974	DBHD-36	<b>2-1/4 lb</b>	4-1/2"	2-3/16"	13-1/2"
740975	DBHD-48	<b>3 lb</b>	4-13/16"	2-3/8"	16-3/4"
740977	DBHD-96	<b>6 lb</b>	7-3/32"	2-3/4"	20"
740978	DBHD-168	<b>10 lb</b>	7-3/32"	2-3/4"	30"
740979	DBHD-190	<b>12 lb</b>	8"	3-5/32"	36-1/2"



## Replaceable Tip Dead Blow - Heavy Duty

- Steel shot filled head directs full force of blow to the work preventing rebound
- Soft face will not mar work
- Welded steel construction
- Hard and soft plastic faces available separately
- TPR handle grip for superior control and user comfort

PROD. NO.	MOD. NO.	Head Weight	Handle Length	Face Diameter
740932	SFH-125	<b>20 oz</b>	10-1/4"	1-3/8"
740933	SFH-175	<b>29 oz</b>	10-1/4"	1-1/2"
740934	SFH-225	<b>38 oz</b>	10-1/4"	1-3/4"

## Replaceable Tips - Dead Blow

PROD. NO.	MOD. NO.	Description	Face Diameter
740994	RTMW-35	Medium Tip for 740932	1-3/8"
740995	RTMW-40	Medium Tip for 740933	1-1/2"
740996	RTMW-45	Medium Tip for 740934	1-3/4"
740997	RTSB-35	Soft Tip for 740932	1-3/8"
740998	RTSB-40	Soft Tip for 740933	1-1/2"
740999	RTSB-45	Soft Tip for 740934	1-3/4"



740933



## PUNCH AND CHISEL - SETS

- Made of the highest grade carbon steel, accurately hardened and tempered preventing splintering and extending life
- Powder coated shank protects against rust
- Edges accurately tempered to stay sharp
- Extra-thick hexagonal shanks minimize roll away
- Working ends accurately ground and hardened to HRC 52-58 for maximum service
- Striking end hardened to HRC-42 maximum – won't chip or mushroom
- Meets Canadian Government Specifications CDA39GP-43a

**WARNING:** Always use punches and chisels on materials softer than the hardness of the punch itself



### 6 PC Pin Punch Set

775509 / PP-6S

- Pin Punch: 3/32, 1/8, 5/32, 3/16, 1/4, 5/16"
- Terylene Pouch



### 6 PC Roll Pin Punch Set

775526 / RPP-6S

- Roll Pin Punch: 3/32, 1/8, 5/32, 3/16, 1/4, 5/16"
- Terylene Pouch



### 6 PC Cold Chisel Set

775531 / CC-6S

- Cold Chisel: 1/4, 5/16, 3/8, 1/2, 5/8, 3/4"
- Terylene Pouch



**WARNING:** Always wear safety goggles

**8 PC Punch and Chisel Set** 775507 / PC8-1S

- Cold Chisel: **1/2, 5/8, 3/4"**
- Centre Punch: **5/32"**
- Solid Punch: **3/16"**
- Pin Punch: **1/8, 3/16, 1/4"**
- **Terylene Pouch**



**14 PC Punch and Chisel Set** 775511 / PC-14S

- Cold Chisel: **3/8, 1/2, 5/8, 3/4, 7/8"**
- Centre Punch: **5/32, 1/4"**
- Solid Punch: **1/8, 5/16"**
- Drift Punch: **1/8, 5/32"**
- Pin Punch: **1/16, 1/8, 3/16"**
- **Terylene Pouch**



**16 PC Punch and Chisel Set** 775508 / PC16-1S

- Cold Chisel: **5/16, 1/2, 5/8, 3/4, 7/8"**
- Centre Punch: **1/8, 5/32, 1/4"**
- Solid Punch: **1/8, 3/16, 1/4"**
- Drift Punch: **3/16, 1/4"**
- Pin Punch: **1/8, 3/16, 1/4"**
- **Terylene Pouch**



**24 PC Punch and Chisel Set** 775513 / PC24S

- Cold Chisel: **1/4, 5/16, 3/8, 1/2, 5/8, 3/4, 7/8"**
- Centre Punch: **5/64, 5/32, 1/4", ACP-2 Auto**
- Solid Punch: **1/16, 1/8, 5/32, 3/16, 1/4, 5/16"**
- Pin Punch: **1/16, 3/32, 1/8, 5/32, 3/16, 1/4, 5/16"**
- **Terylene Pouch**



**WARNING:** Always wear safety goggles



## PUNCH AND CHISEL - OPEN STOCK

- Made of the highest grade carbon steel, accurately hardened and tempered preventing splintering and extending life
- Powder coated shank protects against rust
- Edges accurately tempered to stay sharp
- Extra-thick Hexagonal shanks minimize roll away
- Working ends accurately ground and hardened to HRC 52-58 for maximum service
- Striking end hardened to HRC-42 maximum – won't chip or mushroom
- Meets Canadian Government Specifications CDA39GP-43a

**WARNING:** Always use punches and chisels on materials softer than the hardness of the punch itself

### Pin Punches

- Ideal for driving out and removing already loosened pins and keys after initial movement by a solid punch

PROD. NO.	MOD. NO.	Point	Shank	Length
775400	PP232	<b>1/16"</b>	1/4"	4"
775401	PP332	<b>3/32"</b>	1/4"	4-1/4"
775402	PP432	<b>1/8"</b>	5/16"	4-3/4"
775403	PP532	<b>5/32"</b>	5/16"	5"
775404	PP632	<b>3/16"</b>	5/16"	5-1/4"
775405	PP832	<b>1/4"</b>	3/8"	5-3/4"
775406	PP1032	<b>5/16"</b>	7/16"	6"

### Roll Pin Punches

- Specifically designed for removing roll pins and spring pins
- Ball end keeps punch centered and allows maximum contact between pin and punch shoulder

PROD. NO.	MOD. NO.	Point	Shank	Length
775452	RPP332	<b>3/32"</b>	1/4"	3-1/2"
775453	RPP432	<b>1/8"</b>	1/4"	3-3/4"
775454	RPP532	<b>5/32"</b>	5/16"	4-1/2"
775455	RPP632	<b>3/16"</b>	5/16"	4-1/2"
775456	RPP832	<b>1/4"</b>	3/8"	5-1/2"
775457	RPP1032	<b>5/16"</b>	3/8"	6"



**WARNING:** Always wear safety goggles



## Solid (Starting) Punches

- Solid (or starting) punches are used prior to using a pin punch and are useful for loosening frozen or tight pins and keys

PROD. NO.	MOD. NO.	Point	Shank	Length
775420	SP116	<b>1/16"</b>	3/8"	5"
775421	SP216	<b>1/8"</b>	5/16"	5"
775422	SP316	<b>3/16"</b>	3/8"	5"
775423	SP416	<b>1/4"</b>	1/2"	5"
775424	SP516	<b>5/16"</b>	1/2"	6"
775425	SP532	<b>5/32"</b>	3/8"	5"

## Centre Punches

- Ideal for clearly marking metal in work layout and making indentations in a workpiece before drilling
- Working tips are centered and ground to a correct 90° included angle

PROD. NO.	MOD. NO.	Point	Shank	Length
775440	CP416	<b>5/64"</b>	1/4"	3-1/2"
775441	CP516	<b>1/8"</b>	5/16"	4-1/2"
775442	CP616	<b>5/32"</b>	5/16"	5-1/2"
775443	CP816	<b>1/4"</b>	3/8"	6"

## Drift (Aligning) Punches

- Ideal for lining up holes in two or more pieces of metal and for drawing pins through various assemblies
- Often referred to as aligning punches. Pry or twist both parts into alignment and then tap gently to ensure perfect alignment

PROD. NO.	MOD. NO.	Point	Shank	Length
775410	AP532	<b>5/32"</b>	3/8"	9"
775411	AP216	<b>1/8"</b>	5/16"	8"
775412	AP316	<b>3/16"</b>	5/16"	10"
775413	AP416	<b>1/4"</b>	3/8"	10"



**WARNING:** always wear safety goggles



## PUNCH AND CHISEL - OPEN STOCK

### Cold Chisels

- Designed for cutting, shaping or removing metals softer than the chisel itself such as wrought iron, unhardened steel, aluminum, brass and copper. Can also be used on some building materials

PROD. NO.	MOD. NO.	Shank	Length	Blade Width
775430	CC430	1/4"	5"	1/4"
775431	CC516	1/4"	5"	5/16"
775437	CC616	5/16"	5-1/2"	3/8"
775432	CC816	7/16"	6"	1/2"
775433	CC1016	1/2"	6-1/2"	5/8"
775434	CC1216	5/8"	7"	3/4"
775435	CC1416	5/8"	8"	7/8"
775436	CC1616	3/4"	8-1/2"	1"

### Cold Chisels - with Safety Grips

- Safety grip protects hand from overstrikes

PROD. NO.	MOD. NO.	Length	Blade Width
775461	CCG-110	10"	1"
775462	CCG-112	12"	1"

### Automatic Centre Punch

- Adjustable tension controls depth of impression

PROD. NO.	MOD. NO.	Length	Diameter
775592	ACP-2	5"	1/2"



**WARNING:** Always wear safety goggles

- Manufactured from high quality steel and induction hardened for durability and extended life
- Stamping end hardened to 58-62 HRC – striking end hardened to 38-43 HRC to prevent splintering
- Striking ends are beveled to prevent breakage and to increase operator safety
- Sets contain: Numbers: 0 - 9 (6 and 9 are interchangeable)
- Letters: A - Z and & (ampersand)



### LS Series - Letter Stamp Sets

PROD. NO.	MOD. NO.	Pieces	Characters	Size
391104	LS-030	27	Letters	<b>3 mm (1/8")</b>
391107	LS-050	27	Letters	<b>5 mm (3/16")</b>
391110	LS-060	27	Letters	<b>6 mm (1/4")</b>

### NS Series - Number Stamp Sets

PROD. NO.	MOD. NO.	Pieces	Characters	Size
391103	NS-030	9	Numbers	<b>3 mm (1/8")</b>
391106	NS-050	9	Numbers	<b>5 mm (3/16")</b>
391109	NS-060	9	Numbers	<b>6 mm (1/4")</b>



**WARNING:** Always wear safety goggles









# CONSTRUCTION TOOLS







# POWER CLAW™



## BARS - POWERCLAW™ SERIES

- Canada's premier super heavy duty wrecking bars are designed for the toughest jobs
- Made of tough heat treated alloy steel rather than carbon steel
- Precision ground claws are sharper and stronger than competitive products
- Electrostatic powder coated for corrosion resistance

### Wrecking Bars - Super Heavy Duty

- Heavy duty extra thick profiled bar stock for maximum strength and leverage
- Extra wide face and unique curve radius allows greater leverage with less operator effort

PROD. NO.	MOD. NO.	Length	Material
779201	JPWB-14	14"	Alloy
779203	JPWB-24	24"	Alloy
779205	JPWB-36	36"	Alloy
779256	JPWB-48	48"	Alloy



779203 Extra wide face and unique curve design provides more leverage with less effort

### Wrecking Bars - Notched Style - Super Heavy Duty

- Extra tight radius on curved end for increased leverage
- Nail notches on both ends for maximum versatility
- Smooth finished oval cross section shaft for maximum comfort and pulling power



PROD. NO.	MOD. NO.	Length	Material
779252	JPNB-18	18"	Alloy
779253	JPNB-24	24"	Alloy
779255	JPNB-36	36"	Alloy



779252 Nail puller notches on both ends

- Canada's premier super heavy duty wrecking bars are designed for the toughest jobs
- Made of tough heat treated alloy steel rather than carbon steel
- Precision ground claws are sharper and stronger than competitive products
- Electrostatic powder coated for corrosion resistance



**Pinch Bars - Hex Shank - Super Heavy Duty**

- Hex shaft bars for maximum comfort
- Pencil and chisel points for a variety of tasks

PROD. NO.	MOD. NO.	Length	Shank Size	Material
779211	JPPB-18	<b>18"</b>	3/4"	Alloy
779212	JPPB-24	<b>24"</b>	3/4"	Alloy
779213	JPPB-30	<b>30"</b>	3/4"	Alloy
779214	JPPB-36	<b>36"</b>	3/4"	Alloy
779215	JPPB-48	<b>48"</b>	1"	Alloy
779216	JPPB-60	<b>60"</b>	1"	Alloy



779211 - 779216 Hex Shank Pinch Bar

**Ironworker's Pinch Bars - Round Shank - Super Heavy Duty**

- Drop forged chrome alloy steel bars for professional use
- Individually magnetic particle tested to ensure complete material integrity
- Entirely heat treated, not just at the working ends, for maximum endurance
- Smooth taper assists in lining up bolt holes
- Fully chrome plated to resist corrosion

PROD. NO.	MOD. NO.	Length	Shank Size	Material
779231	JIWB-18	<b>18"</b>	5/8"	Chrome Alloy
779232	JIWB-24	<b>24"</b>	3/4"	Chrome Alloy
779233	JIWB-30	<b>30"</b>	7/8"	Chrome Alloy
779234	JIWB-36	<b>36"</b>	7/8"	Chrome Alloy



779231 - 779234 Round Shank Pinch Bar

**Crow Bar - Super Heavy Duty**

- Massive bar stock provides maximum strength for heavy prying and lifting jobs

PROD. NO.	MOD. NO.	Length	Weight	Material
779218	JPCB-1860	<b>60"</b>	18 lb	Alloy

**Digging Bar - Super Heavy Duty**

- Pencil point and chisel point for breaking hard packed ground
- Heavy duty bar stock provides maximum leverage for moving rocks

PROD. NO.	MOD. NO.	Length	Shank Size	Weight	Material
779258	JPDB-1772	<b>72"</b>	1"	17 lb	Alloy



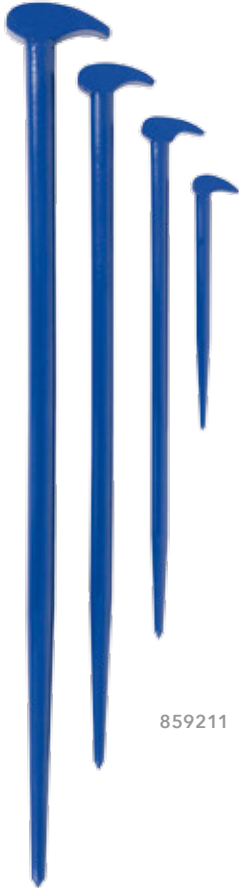

859211

Tapered point

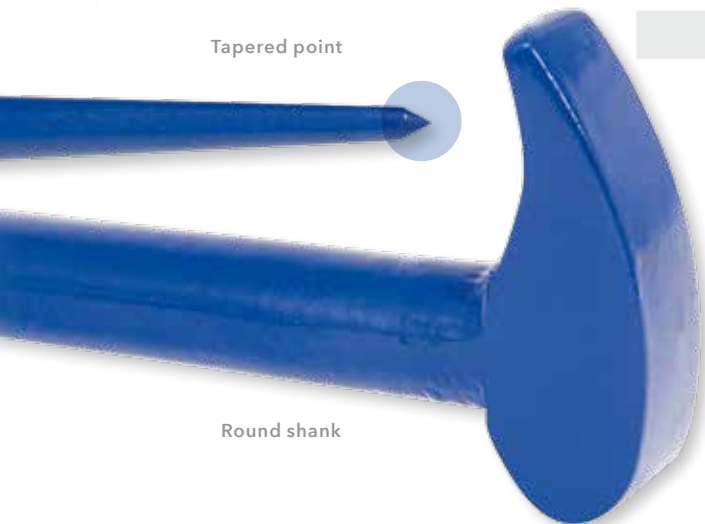

Round shank



779112

**Utility Bar**

PROD. NO.	MOD. NO.	Length	Material
779112	PB-15	15"	Alloy

**Nail Puller**

PROD. NO.	MOD. NO.	Length	Material
779113	JPNP-11	11"	Alloy



779113

**4 PC Rolling Head Pry Bar Set**

859211 / JROE-4S

- Rounded head acts as a fulcrum to provide extra leverage
- Tapered point and round stock ideal for aligning parts through bolt holes
- Heat treated Chrome Vanadium steel for professional use
- Magnetic particle tested to ensure complete material integrity
- Electrostatic powder coat paint protects against corrosion
- Includes: **6, 12, 16, 20"**



**Rolling Head Pry Bars - Open Stock**

PROD. NO.	Length	Contained in Set
859212	6"	859211
859213	12"	859211
859214	16"	859211
859215	20"	859211



Rounded head

## Bolt Cutters - Heavy Duty

- JET bolt cutters are designed to cut soft and medium grade bolts, rods, rivets, bar and chain
- Serrated cutting edges cut with less hand force and prevent material from slipping
- **Chrome Molybdenum** steel blades
- Blades hardened to HRC 55 - 61
- Maximum hardness of material to be cut: HRC 40

PROD. NO.	MOD. NO.	Length	Capacity HRC30	Capacity HRC40	Replacement Head
731108	BC-8	8"	-	-	-
731112	BC-12	12"	3/16"	5/32"	731162
731114	BC-14	14"	1/4"	3/16"	731164
731118	BC-18	18"	5/16"	1/4"	731168
731124	BC-24	24"	3/8"	5/16"	731174
731130	BC-30	30"	1/2"	5/16"	731180
731136	BC-36	36"	5/8"	3/8"	731186
731142	BC-42	42"	3/4"	7/16"	731192



731108

731118

## High Tensile Bolt Cutters - Super Heavy Duty

- Drop forged Chrome Vanadium steel blades specially hardened for use on high tensile steel bolts, rod, and chain
- Induction hardened and quenched cutting edges are suitable for cutting materials up to HRC 48
- Cutting head painted red to designate high tensile cutting ability
- Drop forged adapter and heat treated handles for maximum strength
- Powder coated for resistance to corrosion
- Meets US Federal Government Specification GGG-C-740d Type II Class 3 & 4

PROD. NO.	MOD. NO.	Length	Capacity HRC30	Capacity HRC40	Capacity HRC48	Replacement Head
731238	BCR-18	18"	5/16"	1/4"	7/32"	731278
731244	BCR-24	24"	3/8"	5/16"	9/32"	731284
731256	BCR-36	36"	5/8"	15/32"	11/32"	731296



731238



**BOLT & ROD CUTTERS**



Serrated Cutting Edge

Hardened drop forged Chrome Vanadium blades for long life

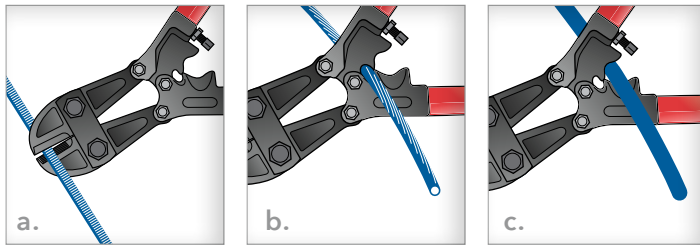

Bolt

Wire Rope

Cable



731204

**3-in-1 Bolt Cutters**

- Unique design cuts bolts, rods, wire and cable
- Hardened drop forged Chrome Vanadium blades for long life
- Serrated cutting edges cut with less hand force and prevent material from slipping
- Bolt cutter blades are easily adjustable and replaceable
- Blade hardness HRC55 – 60
- Maximum material hardness HRC 42

PROD. NO.	MOD. NO.	Size	Bolt	Rebar	Wire Rope	Cable	Replacement Head
731204	BCW-18	<b>18"</b>	5/16"	1/4"	3/16"	3/8"	731214
731205	BCW-24	<b>24"</b>	13/32"	5/16"	9/32"	1/2"	731215



**Rod Cutter and Bender**

- A premium industrial quality rod cutter / bender for heavy duty construction applications
- Bends 5/8" rebar up to 180°

PROD. NO.	MOD. NO.	Capacity	Replacement Head
735403	RC-16	<b>5/8"</b>	731453





## Tape Measures - Heavy Duty

- Extra wide tape provides 8' standout
- High contrast blade for easy reading
- 1/16" increments on SAE scale
- Integral rubber inserts provide maximum grip and protection
- Built-in bumper cushions recoil impact
- Easy slide lock
- Meets GS / TUV and CE standards
- Available individually carded or in display case of 12 carded tapes

PROD. NO.	MOD. NO.	Scale	Width	Overall Length
775921	JTM-416SM	SAE/Metric	1"	16' / 5m
775928	JTM-425S	SAE	1"	25'
775929	JTM-425SM	SAE/Metric	1"	25' / 7.5m



## Extra Long Steel Tape Measure

775936 / JSTM-100SM

- Two sided tape features SAE measurements on one side, metric on the other
- Fast rewind provided by fold-away handle
- High contrast blade for easy reading
- 0 point inside ring
- Meets GS / TUV and CE standards
- 3/8" width
- 100' / 30m length



## Open Reel Fibreglass Tape Measure

775910 / JFTM-165SM

- Two sided tape features SAE measurements on one side, Metric on the other
- Fast rewind provided by fold-away handle
- 0 point inside ring
- PVC coating prevents rot, facilitates cleaning - can be rewound when wet
- Ergonomic case with sure grip
- Tape can be removed and rewound to show either scale face up
- Meets GS / TUV and CE standards
- 1/2" width
- 165' / 50 m length



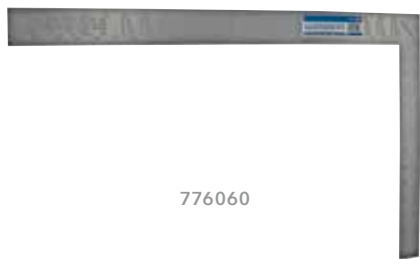

776060



## MEASURING TOOLS

### Framing and Layout Square

- Lacquer coated steel squares resist rust
- Clear permanently etched graduations
- 1/8" increments on all edges
- Rafter square has brace scale and rafter table

PROD. NO.	MOD. NO.	Scale	Blade	Tongue
776055	JSCS-812	SAE	1-1/2" x 12"	1" x 8"
776060	JSRS-1624	SAE	2" x 24"	1-1/2" x 16"

### Rafter Angle Square

776061 / JRAS-710

- Extra thick aluminum extrusion is stronger than brittle die casts
- Will not rust
- Clear permanently etched graduations
- Measures hip, valley and common rafter angles
- Most versatile square – combines rafter and framing square, protractor, try square, mitre square and saw guide
- **7" x 7" x 10"**
- Scale SAE

### Combination Square

776065 / JCS-12

- Die cast aluminum head for accuracy and durability
- Stainless steel blade with etched graduations
- SAE scale on all edges allows marking on both sides of blade
- Built in level for improved accuracy and versatility
- Convenient scratch awl
- Meets GS / TUV and CE standards
- Blade: **1" x 12"**

### T-Bevel Square

776070 / JTB-8

- Use to measure and transfer angles
- SAE and Metric graduations
- Built in level for improved accuracy and versatility
- Large knurled locking wheel will not jam
- Steel blade with ABS handle
- Meets GS / TUV and CE standards
- Blade: **2" x 8"**

## Aluminum Box Levels

- Box beam construction with reinforcing ribs prevents twisting and bending under normal use
- Precision milled on both surfaces for maximum accuracy
- 3 shatter-resistant acrylic block vials read horizontal, plumb and 45°
- Top read centre vial provides 300° viewing for easy readability
- Oversized hand holes for sure grip
- Shock absorbing beveled end caps
- Bright yellow finish for improved visibility
- Meets GS / TUV and CE standards

PROD. NO.	MOD. NO.	Overall Length	Vials
776001	JBL-9924B	24"	3
776002	JBL-9948B	48"	3
776004	JBL-9972B	72"	3

Top read centre vial



776001

## Aluminum Box Levels - Heavy Duty

- Extra thick aluminum stock extruded into a unique profile offers the ultimate in strength and resistance to twisting
- Precision milled on both surfaces for maximum accuracy
- V-groove on bottom surface for use on pipe
- Hidden magnets in bottom surface hold level securely to metal objects
- 3 shatter-resistant mono block acrylic vials (1 horizontal, 2 plumb)
- Top read centre vial provides 300° visibility
- Double layer rubber and plastic end caps offer superior shock absorption
- Meets GS/TUV and CE standards

PROD. NO.	MOD. NO.	Overall Length	Vials
776021	JPBL-24	24"	3
776022	JPBL-48	48"	3

Top read centre vial



Magnetic V-grooved base

776021

Double layer end cap for superior shock absorption



779161



## MEASURING TOOLS

### Torpedo Level

776006 / JTL-9B

- 9" aluminum frame for improved accuracy and durability
- Top read centre vial for easy readability, provides 300° viewing
- 3 vials read horizontal, plumb and 45°
- White frame around vials for improved readability
- Magnetic strip holds level securely to metal objects
- Meets GS / TUV and CE standards

### Chalk Line Set

779161 / JACL-100S

- Aluminum case for maximum durability
- Holds 100' of line
- Can be used as a plumb bob
- Includes 3" line level and 4 oz. chalk

### Replacement Chalk

779162 / JBPC-4

- 4 oz. fine blue layout chalk
- For use with any chalk line reel

### Plumb Bob - Brass

779171 / JBPB-12

- 12 oz. solid machined brass
- Hardened steel replaceable tip
- Extra tip included
- Top unscrews for easy line centering

## STAPLERS AND TACKERS

- JET staplers and hammer tackers are designed for professional use
- Durable all steel or aluminum construction
- Nickel plated finish resists corrosion
- Low staple viewing window
- Handle lock allows compact storage

## STAPLE GUNS

### Standard Duty

849403 / JSG-103

- Exclusive swing-away channel for easy clearing of jammed staples
- Perfect for light to medium duty applications
- Uses **1/4" - 5/16" Standard Duty JET staples** or equivalent

### Heavy Duty

849411 / JSG-101HD

- Comfortable PVC hand grip
- For upholstery, fencing, carpeting, ceiling tile, insulation and many other uses
- Uses **1/4" - 9/16" Heavy Duty JET staples** or equivalent

### Staple / Nail Gun - Heavy Duty

849412 / JSG-102HD

- Die cast aluminum alloy housing will not rust
- Ergonomic design allows application of maximum pressure without fatigue
- 2 position adjustment lever provides the ideal power for use on soft or hard materials
- Bi-material hand grip for increased comfort
- Bottom loading design for fast refills and easy clearing of jammed staples
- For upholstery, fencing, carpeting, ceiling tile, insulation and many other uses
- Unique lock allows compact storage
- Uses **1/4" - 9/16" Heavy Duty JET staples** or equivalents and **18 gauge brad nails**
- Low staple viewing window



849403



849411





## STAPLERS AND TACKERS

### Hammer Tackers

#### Standard Duty

849409 / JHT-102

- Perfect for light to medium applications
- Large PVC grip for maximum comfort
- Uses **1/4" - 5/16" Standard Duty JET staples** or equivalent

#### Heavy Duty

849416 / JHT-101HD

- 32 oz total weight provides maximum hitting power
- Ideal for carpet and underlay, roofing felt, plastic sheeting etc.
- Comfortable rubber handle for maximum grip
- Rear loading magazine
- Uses **1/4" - 3/8" Heavy Duty JET staples** or equivalent

#### Staples

- Designed for use with JET staplers or any brand compatible with Arrow® T-50 or JT-21 staplers
- 1,000 staples per box
- Available in various lengths from 1/4" to 9/16"
- Available for standard duty and heavy duty applications

PROD. NO.	MOD. NO.	Description	Use With Models
849481	JS-1006	<b>1/4" SD Staples</b>	849403 (JSG-103) 849407 (JHT-102)
849482	JS-1008	<b>5/16" SD Staples</b>	849403 (JSG-103)
849491	JS-1006HD	<b>1/4" HD Staples</b>	849411 (JSG-101HD) 849412 (JSG-102HD) 849416 (JHT101HD)
849492	JS-1008HD	<b>5/16" HD Staples</b>	849411 (JSG-101HD) 849412 (JSG-102HD) 849416 (JHT101HD)
849493	JS-1010HD	<b>3/8" HD Staples</b>	849411 (JSG-101HD) 849412 (JSG-102HD) 849416 (JHT101HD)
849494	JS-1012HD	<b>1/2" HD Staples</b>	849416 (JSG-101HD) 849412 (JSG-102HD)
849495	JS-1014HD	<b>9/16" HD Staples</b>	849411 (JSG-101HD) 849412 (JSG-102HD)

- Cast aluminum frames combine high strength with light weight
- TPR grip on handle for comfort and secure grip
- Blade can be angle mounted for special applications
- Powder coated for added resistance to corrosion

### 12" Ergonomic Frame

775306 / 525A

- Heavy ergonomic frame accepts 12" blades
- Front frame with contoured grip for better control
- Convenient in handle blade storage



12" Blades

### 12" Oval Tube Style - Heavy Duty

775307 / JHS-5012

- Oval tube provides greater strength than square tube saws
- Extra thick cast aluminum frame components for heavy duty professional applications
- Easy to use wing nut provides up to 3,000 PSI tension on blade
- Blade can be mounted at 45° for special applications
- Unique blade storage compartment holds up to 6 spare blades



12" Blades

### 12" Aluminum I-Beam Style

775308 / JHS-3012

- One piece cast aluminum I-beam frame for rigidity
- Easy to use wing nut provides up to 2,500 PSI tension on blade
- Blade can be mounted at 45° for special applications



12" Blades

### JET-KUT® Bi-Metal Hacksaw Blades

- Bi-metal construction with carbon steel core and high speed steel teeth thermally treated under high vacuum
- Flexible and shatterproof safety blades
- An excellent performing, long lasting blade for a wide range of applications

PROD. NO.	Size (inches) L x W x T	Teeth TPI	Pkg Qty
566231	12 x 1/2 x 0.25	18	10 / 100
566232	12 x 1/2 x 0.25	24	10 / 100
566233	12 x 1/2 x 0.25	32	10 / 100



566231



566232



566233







# SHOP EQUIPMENT





# C-CLAMPS



Mini Size Clamps



## CCJ - Series Junior C-Clamps

- Drop forged steel frames for maximum strength in a minimum size
- Powder coated frames and zinc plated screws resist corrosion
- Narrow frames allow use in the most confined spaces
- Swivel pads adopt correct angle for maximum pressure

PROD. NO.	MOD. NO.	Maximum Opening	Throat Depth	Clamping Pressure (lb)
390151	CCJ-100	1"	1"	500
390153	CCJ-150	1-1/2"	1-1/2"	850
390155	CCJ-200	2"	1-1/4"	875
390157	CCJ-300	3"	1-3/8"	850

## CSG Series - Cast Iron Clamps

- SG Cast Iron clamps with Spheroidal Graphite structure produces 60,000 PSI tensile strength - twice the tensile strength of ductile iron clamps!
- Guaranteed unbreakable during normal use
- Reinforced frame corners
- Cross handle designed to bend before the frame can be over stressed
- Acme threaded screw for smooth operation and even clamping pressure
- Black oxide coated screw and handle resists weld and corrosion

PROD. NO.	MOD. NO.	Maximum Opening	Throat Depth	Clamping Pressure (lb)
390142	CSG-4	4"	2-11/32"	2,640
390143	CSG-6	6"	3"	2,860
390144	CSG-8	8"	3-1/8"	2,640
390145	CSG-10	10"	3-1/2"	2,530
390146	CSG-12	12"	4"	2,530



## CC Series - Regular Throat Clamps - Heavy Duty

- Industrial quality drop forged heat treated steel C-clamps
- Heavy duty swivel pads are secured by a special retaining clip that is superior to crimped pads
- Acme threaded screw for smooth operation and even clamping pressure
- Black oxide screw resists welding spatter

PROD. NO.	MOD. NO.	Maximum Opening	Throat Depth	Clamping Pressure (lb)
390102	CC-2	<b>2-3/16"</b>	1"	3,300
390103	CC-3	<b>2-5/8"</b>	1-1/2"	4,350
390104	CC-4	<b>4"</b>	1-3/4"	5,300
390105	CC-5	<b>4-5/8"</b>	2-1/16"	5,900
390106	CC-6	<b>6-1/4"</b>	2-1/2"	7,650
390108	CC-8	<b>7-1/2"</b>	3-1/4"	8,850
390110	CC-10	<b>9-1/2"</b>	4-1/4"	9,000
390112	CC-12	<b>11-9/16"</b>	4-1/2"	13,000



390102



390106

## CC-D Series - Deep Throat Clamps - Heavy Duty

- Industrial quality drop forged heat treated steel C-clamps
- Extra deep throat depths for maximum versatility
- Smooth acting Acme threaded screws for maximum clamping force
- Black oxide coated screw and pads minimize splatter adhesion
- Special pad retaining clips are superior to crimped pads
- Unique clamp profile provides incredible strength yet is lighter than most competing models
- Ideal for all welding and clamping applications

PROD. NO.	MOD. NO.	Maximum Opening	Throat Depth	Clamping Pressure (lb)
390122	CC-2D	<b>2-1/8"</b>	2-1/4"	3,500
390123	CC-3D	<b>3"</b>	2-1/2"	3,500
390124	CC-4D	<b>4-1/4"</b>	3-1/4"	6,200
390125	CC-6D	<b>6-1/16"</b>	4-1/8"	6,600
390126	CC-8D	<b>8-1/4"</b>	5"	6,900
390127	CC-10D	<b>10-1/8"</b>	6"	8,000
390129	CC-12D	<b>12-1/4"</b>	6-5/16"	9,300

Extra Deep Throats



390124



390125



## L-CLAMPS

- Tempered drop forged sliding arm reduces clamping set up time – ideal for high volume production work
- Nickel-chrome plated rails are heat formed from cold drawn profiled steel
- Extra deep throats for maximum versatility
- High carbon Acme threaded spindle is spatter resistant
- Rails, sliding arms, and spindles 100% heat treated
- Replaceable spindle and pads
- Specialized pads available for JLHD and JLSJ Series



390202



390224

### JLRD Series - L-Clamps

- Generous clamping pressure and throat depth for a wider range of applications
- Standard swivel pads

PROD. NO.	MOD. NO.	Opening	Throat Depth	Rail Size	Clamping Pressure (lb)
390202	JLRD-6	<b>6"</b>	4-3/4"	1-3/16 x 9/16"	2,640
390204	JLRD-8	<b>8"</b>	4-3/4"	1-3/16 x 9/16"	2,640
390206	JLRD-10	<b>10"</b>	4-3/4"	1-3/16 x 9/16"	2,640
390208	JLRD-12	<b>12"</b>	5-1/2"	1-3/16 x 9/16"	2,640
390210	JLRD-16	<b>16"</b>	4-3/4"	1-3/16 x 9/16"	2,640
390212	JLRD-20	<b>20"</b>	4-3/4"	1-3/16 x 9/16"	2,640

### JLHD Series Deep Throat Clamps - Heavy Duty

- Increased throat depth and heavy duty cold forged swivel pads
- Pads tilt to 35°
- Serrated and V-Pads available for special applications

PROD. NO.	MOD. NO.	Opening	Throat Depth	Rail Size	Clamping Pressure (lb)
390224	JLHD-8	<b>8"</b>	5-1/2"	1-3/16 x 9/16"	2,640
390226	JLHD-10	<b>10"</b>	5-1/2"	1-3/16 x 9/16"	2,640
390228	JLHD-12	<b>12"</b>	5-1/2"	1-3/16 x 9/16"	2,640
390230	JLHD-16	<b>16"</b>	5-1/2"	1-3/16 x 9/16"	2,640
390232	JLHD-20	<b>20"</b>	5-1/2"	1-3/16 x 9/16"	2,640
390233	JLHD-24	<b>24"</b>	5-1/2"	1-3/16" x 9/16"	2,640

## JLSD Series - Deep Throat Clamps - Super Heavy Duty

- The ultimate in depth and strength
- 45% greater clamping pressure than our heavy duty clamps
- Serrated and V-pads available for special applications

PROD. NO.	MOD. NO.	Opening	Throat Depth	Rail Size	Clamping Pressure (lb)
390248	JLSD-12	12"	6-3/4"	1-9/16 x 3/4"	4,840
390250	JLSD-16	16"	6-3/4"	1-9/16 x 3/4"	4,840
390252	JLSD-20	20"	6-3/4"	1-9/16 x 3/4"	4,840
390254	JLSD-24	24"	6-3/4"	1-9/16 x 3/4"	4,840



## L-Clamp Accessories

- Replacement parts for L-Clamps

PROD. NO.	Description	PROD. NO.	Description
390292	Plain Pad for JLHD/JLSD L-Clamp	390296	Screw & Handle for JLHD L-Clamp
390293	Serrated Pad for JLHD/JLSD L-Clamp	390297	Screw & Handle for JLSD L-Clamp
390294	V Pad for JLHD/JLSD L-Clamp	390298	Nut for JLHD/JLSD L-Clamp
390295	Screw & Handle for JLRD L-Clamp	390299	Ball Joint for JLHD/JLSD L-Clamp





## PIPE CLAMP

### JPC Series - Pipe - Heavy Duty

390482 / JPC-7500

- Uses standard 3/4" threaded pipe (not included)
- Flat base allows clamp to stand on work bench for stable support
- Clamp height allows full turn of handle without contacting work surface
- Non-marring pads protect work from damage

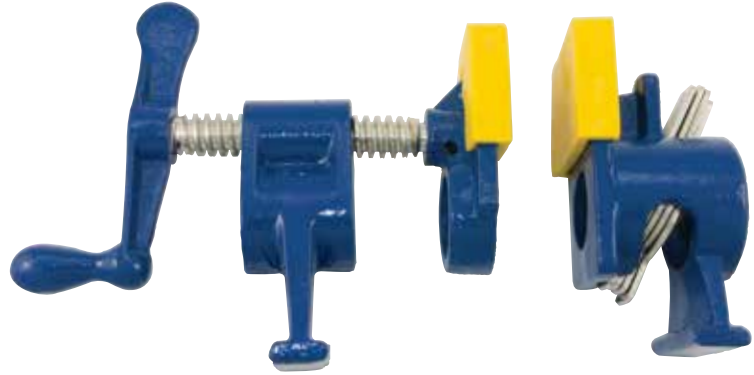

Flat base allows stable support on work bench and allows handle to turn without contacting surface

## SPRING HAND CLAMPS

### JSSC Series - Steel / Woodworking

- Nickel plated to resist corrosion
- Vinyl grips for sure hold
- Use anywhere moderate clamping pressure is required

PROD. NO.	MOD. NO.	Nominal Opening	Overall Length
390457	JSSC-4	1"	4"
390458	JSSC-6	2"	6"

# VICES

Precision machined  
hardened steel jaws

## JSV Series - Swivel Vise - Heavy Duty

- Class 30 iron, 30,000 lb tensile strength castings
- Precision machined hardened steel jaws (replaceable)
- Built-in pipe jaws
- Machine ground anvil surface
- 360° swivel base with dual lock down handles
- Shot blast finish powder coat paint for protection from corrosion

PROD. NO.	MOD. NO.	Jaw Width	Maximum Opening	Throat Depth	Pipe Capacity	Product Weight
320151	JSV-4HD	4"	4"	2-3/4"	1-1/2"	23 lb (10 kg)
320152	JSV-5HD	5"	5"	3-3/4"	2"	31 lb (14 kg)
320153	JSV-6HD	6"	6"	4"	2-1/2"	45 lb (20 kg)
320154	JSV-8HD	8"	8"	4"	3-1/2"	70 lb (31.5 kg)



320154





320312



320316

## VICES

### SG Iron Series - Super Heavy Duty

- Strongest cast vise on the market
- Massive casting made of superior quality 80,000 PSI tensile strength SG iron for maximum strength and impact resistance
- Spheroidal graphite (SG) iron forms a much stronger molecular structure than regular cast iron
- Up to 30% higher tensile strength than competing ductile iron vises
- Precision machined hardened steel jaws
- Polished ACME threaded screw for smooth operation and maximum strength
- Sliding beam is accurately machined on all sides for smooth operation
- Enclosed at the back to protect screw from dirt and debris
- Shot blast finish powder coat paint for protection from corrosion
- Optional 360° swivel base with dual lock down handles

PROD. NO.	MOD. NO.	Jaw Width	Maximum Opening	Throat Depth	Product Weight
320312	JVSG-4	4"	4-5/8"	2-3/4"	31 lb (14 kg)
320313	JVSG-5	5"	7-1/16"	3-11/32"	51 lb (23 kg)
320314	JVSG-6	6"	7-7/8"	3-1/2"	73 lb (33 kg)
320315	JVSG-8	8"	8-7/8"	4-3/32"	88 lb (39-1/2 kg)



### Swivel Base for SG Iron Vise - Super Heavy Duty

- Swivel base converts standard JVSG vises to swivel operation for added versatility
- Powerful dual locking handles keep vise in place
- Made of the same SG ductile cast iron as the vise for maximum strength

PROD. NO.	MOD. NO.	Size	Product Weight
320316	JVSG-4	4"	6 lb (2.7 kg)
320317	JVSG-5	5"	9.9 lb (4.45 kg)
320318	JVSG-6	6"	13.8 lb (6.21 kg)
320319	JVSG-8	8"	17.4 lb (7.83 kg)



### MPV Series Multi-Purpose Vise - Heavy Duty

- Class 30 iron, 30,000 lb tensile strength castings
- Precision machined heavy duty steel jaws (replaceable)
- Jaws can be locked at any angle
- Index scale allows accurate adjustment of jaw angle
- 360° swivel base with dual lock down handles

PROD. NO.	MOD. NO.	Jaw Width	Maximum Opening	Throat Depth	Pipe Capacity	Product Weight
321336	MPV-125S	5"	4-11/16"	3"	3"	46 lb (20 kg)

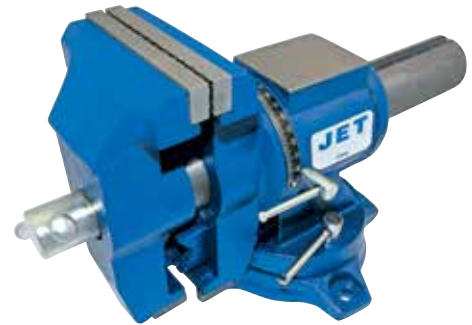

### DPV Series Drill Press Vise - Heavy Duty

- Accurately ground base and slides
- Uni-grip mechanism allows powerful clamping force with minimal effort
- Eliminates need for crossbars or drop away handles
- Replaceable jaws hold round objects securely

PROD. NO.	MOD. NO.	Jaw Width	Maximum Opening	Jaw Depth
321124	DPV-4U	4"	3-1/2"	1-3/16"

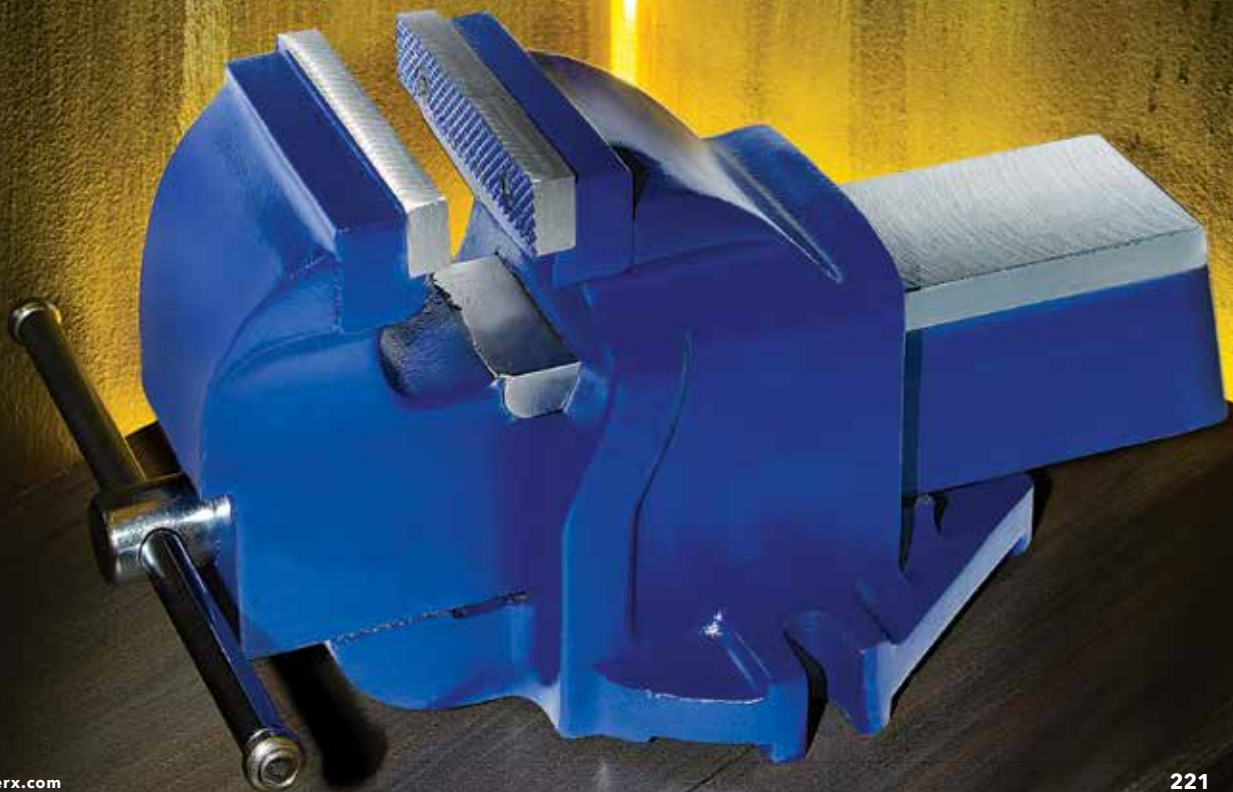
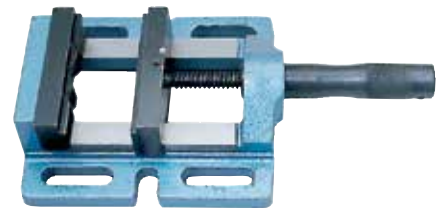



# PALLET TRUCK

## PT Series – Heavy Duty

- High quality 5,500 lb capacity
- High tensile steel frame and one piece "C" section forks with welded reinforcement for superior strength
- 3 position control lever automatically returns to neutral position
- Handle operates from rear and sides and returns to upright position when released
- Ergonomic handle grip for operator comfort and positive control
- Entry rollers in front of load rollers allow easy entry and exit from pallets
- Totally sealed hydraulic pump for reliable leak-free operation
- Built-in overload protection and top of stroke bypass valve prevents damage
- Slow lowering hand control valve for optimum control
- Large diameter polyurethane coated steel steer wheels and polyurethane load rollers for maximum maneuverability and smooth transport of heavy loads
- Steering column swivels 202°
- Fully adjustable push rods for fork height adjustment
- 27" x 48" forks are extra wide for maximum strength
- Grease fittings at all key points

Heavy lifting  
See our Material Handling section  
for similar products

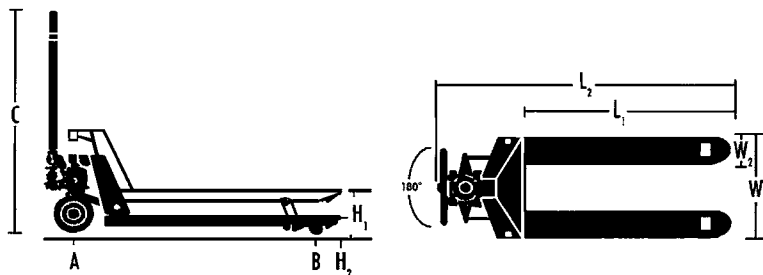

PROD. NO.	MOD. NO.	Rated Lifting Capacity (lb)	Skid Quantity	W1	W2	L1	L2	H1	H2	A	B	Product Weight (lb/kg)
190918	PT-5500	5,500	6	27"	7"	48"	61-1/2"	7-1/4"	2-31/32"	7-7/8" x 2-1/2"	2-29/32" x 3-55/64"	209 lb (95 kg)



Totally sealed H.D. hydraulic unit.



Three position control lever for operator convenience.



Heavy duty single front wheel with entry, exit roller wheel.



Fully adjustable push rods.

# SCISSOR LIFT HAND CART



## SLC Series – Heavy Duty

- Hydraulic table designed for lifting and lowering
- Foot pedal for easy table lifting
- Wire control for convenient operation is superior to knob control
- Large table size
- Wheel stops for positioning cart
- Polyurethane casters for smooth travel
- Industrial quality



PROD. NO.	MOD. NO.	Rated Lifting Capacity (lb)	Minimum Table Height	Maximum Table Height	Handle Height	Table Dimensions	Wheel Diameter	Foot Pedal Cycles to Max. Height
190968	SLC-1100	1,100	11-1/2"	35-3/4"	38-7/8"	33-1/2 x 19-3/4"	5"	27





## PARTS WASHERS

### 20 Gallon - Heavy Duty

- Lid hinge equipped with fusible link for added fire safety
- 45 litre working capacity tank includes basket and work shelf
- Flexible delivery spigot
- Screened inlet protects pump from foreign material
- cUL approved pump
- For use with water-based cleaning solutions with a pH of 7-8

PROD. NO.	MOD. NO.	Motor	Tank Dimensions
355002	JPW-634	<b>115 Volt / 60 Hz. 0.5 Amp</b>	30" W. x 21" D. x 36" H.

### 40 Gallon - Heavy Duty

- Lid hinge equipped with fusible link for added fire safety
- Extra large (70-83 litre) working capacity
- Comes with ground fault interrupt plug
- cUL approved pump
- For use with water-based cleaning solutions with a pH of 7-8

PROD. NO.	MOD. NO.	Motor	Tank Dimensions
355008	JPW-40	<b>115 Volt / 60 Hz. 0.5 Amp</b>	43-1/4" W. x 10-5/8" D. x 20-1/2" H.

### Flo-Thru Parts Brush

- Reduce parts cleaning time by 50%
- 4" long bristles suitable for use with water based (aqueous) cleaner
- Easy attachment fitting fits most parts washers

PROD. NO.	MOD. NO.	Product Dimension
355091	JPWB-6356	10" L. x 1-1/2" W.



**37" Fixed Head 6 Wheel Creeper**

- Creepers make repairs faster and easier
- Full length padded centre panel
- Six double post swivel casters for easy maneuverability and even distribution of weight to prevent creeper from bowing
- Creeper bed is only 3-1/2" high

PROD. NO.	MOD. NO.	Length x Width x Height	Clearance	Maximum Capacity	Wheel Size
355105	JFHC-640	37" x 18" x 3-1/2"	3-1/2"	300 lb	2-1/2"



Double post casters for maximum strength

**42" Adjustable Head Creeper**

- Adjustable headrest reduces stress on neck muscles
- Drop shoulder for ease of movement
- Six double post casters for easy maneuverability and even distribution of weight to prevent creeper from bowing

PROD. NO.	MOD. NO.	Length x Width x Height	Clearance	Maximum Capacity	Wheel Size
355115	JAHC-643	42" x 15" x 3-1/2"	3-1/2"	300 lb	2-1/2"



**6 Wheel Mechanic's Creeper**

- Unique closed cell construction provides unparalleled strength and rigidity
- Designed for unrestricted arm movement
- 6 large double post casters with ball bearings for easy maneuverability
- Dual parts trays
- Large padded head rest
- Can be hung out of the way using convenient handle
- Made of high quality chemical resistant HDPE for long life
- Easily recyclable where facilities exist



PROD. NO.	MOD. NO.	Length x Width x Height	Clearance	Maximum Capacity	Wheel Size
355130	JBMC-620	39-1/2" x 18-1/2" x 4-5/16"	7/8"	400 lb	3"





## ROLLER SEATS

### Mechanic's Roller Seat

- Padded seat rolls on ball bearing casters
- Reinforced vinyl over 1-3/4" thick foam
- Convenient under seat tray keeps tools and parts in easy reaching distance
- Frame is constructed of 1" steel tubing

PROD. NO.	MOD. NO.	Width x Depth x Height	Maximum Capacity	Casters (4)
355153	JMS-641	<b>14" x 17-1/2" x 14-1/4"</b>	300 lb (135 kg)	2-1/2"



### Mechanic's Adjustable Height Roller Seat

- Air piston allows for height adjustment
- Padded seat rolls on ball bearing casters
- Convenient under seat tray keeps tools and parts in easy reaching distance

PROD. NO.	MOD. NO.	Height	Maximum Capacity	Casters (5)
355158	JMS-642	18"	300 lb (135 kg)	2-1/2"

## Anti-Fatigue Mats

- Thick closed cell EVA foam pads protect workers from hard, rough surfaces
- Resists absorption of water, oil and many chemicals, is non-conductive and easy to clean
- Ultra-light weight for portability, with convenient hand hole for easy carrying and storage
- Can be used as an anti-fatigue mat, kneeling pad, under car mat, or anywhere a worker needs to be kept off the ground
- Ideal for service vehicles, roofers, installers, mechanics, shippers, production line workers, store clerks etc.
- Due to the nature of this product no warranty is offered

PROD. NO.	MOD. NO.	Product Dimension (Width x Depth x Height)
355191	JAFM-500	19-1/4" x 11-3/4" x 1-3/16"
355193	JAFM-1100	43" x 19-5/8" x 1-3/16"









# METAL / WOODWORKING MACHINERY

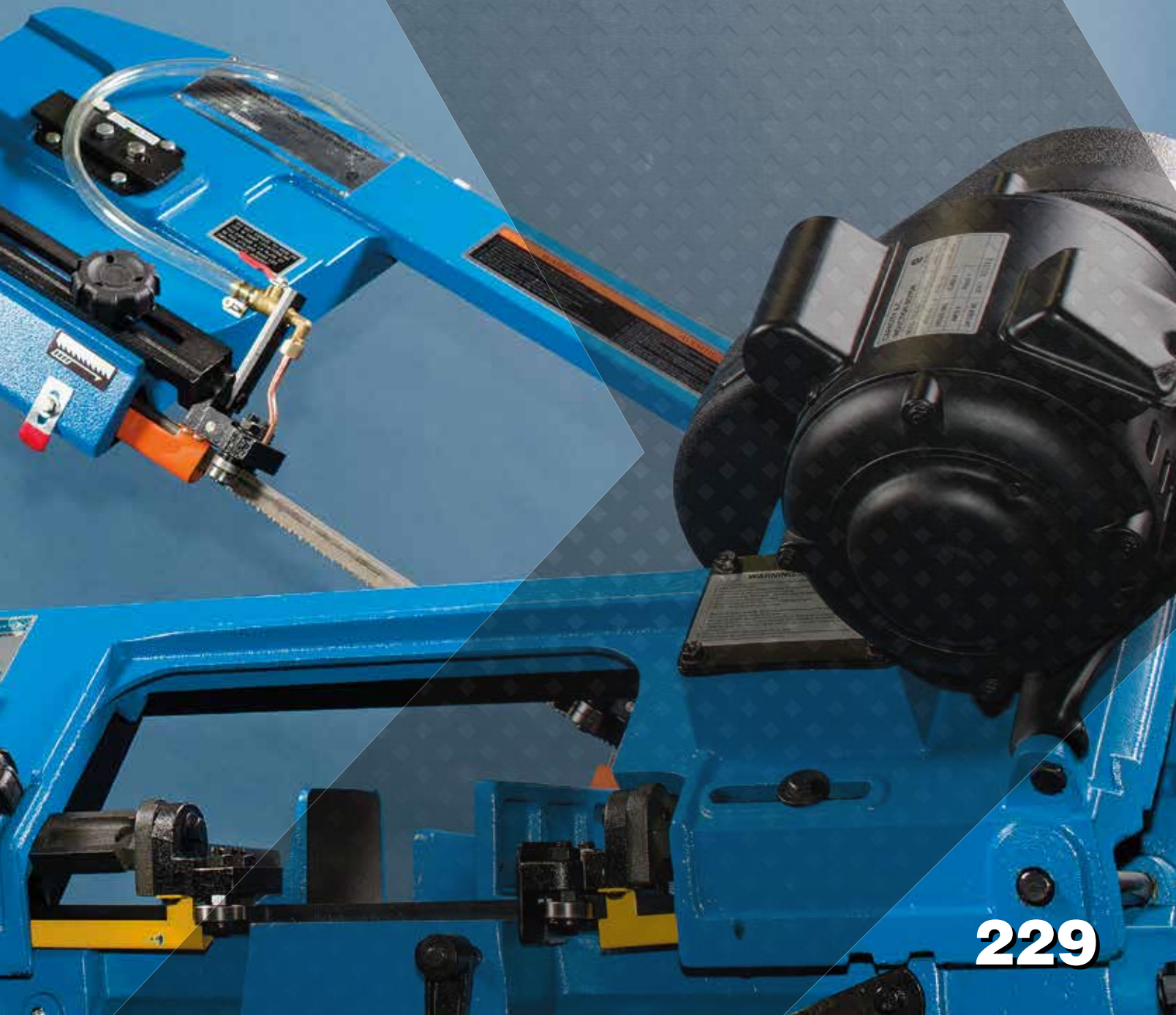

**229**





**2** YEAR WARRANTY

## BENCH GRINDERS

- Heavy duty construction for maximum service life
- CSA electrics for safety and reliability
- All ball bearing construction
- Steel wheel covers with rear dust exhaust ports
- Easy to adjust steel tool rests
- Eye shields and spark guards for operator safety
- Rubber feet on base for reduced vibration
- Includes coarse and medium grinding wheels

### Heavy Duty

PROD. NO. MOD. NO.	240153 BGC-6	240154 BGC-8
Motor	1/3HP, 1Ph, 115V	1/2HP, 1Ph, 115V
Amperage	3.5, 60Hz	5, 60Hz
R.P.M.	3,450	3,600
Arbor Size	1/2"	5/8"
Wheel Size	6" x 3/4" x 1/2"	8" x 1" x 5/8"
Product Weight	26 lb	39 lb
Shipping Weight	28 lb	42 lb

## OPTIONAL ACCESSORIES

See our Abrasives Section

### JET High Performance Wire Brushes

PROD. NO.	MOD. NO.	Dia.	Min Face Width	Centre Hole	Maximum RPM	Wire Dia. & Type
550121	101F-2M	6"	7/8"	1/2" - 5/8" - 2"	6,000	.014" <b>M</b>
550123	101F-2F	6"	7/8"	1/2" - 5/8" - 2"	6,000	.007" <b>F</b>
550124	101F-3C	6"	1"	1/2" - 5/8" - 2"	6,000	.020" <b>C</b>
550125	101F-3M	6"	1"	1/2" - 5/8" - 2"	6,000	.014" <b>M</b>
550141	101G-2C	8"	7/8"	1/2" - 5/8" - 2"	4,500	.020" <b>C</b>
550142	101G-2M	8"	7/8"	1/2" - 5/8" - 2"	4,500	.014" <b>M</b>
550143	101G-2F	8"	7/8"	1/2" - 5/8" - 2"	4,500	.007" <b>F</b>

**F** = Fine      **M** = Medium      **C** = Coarse

550125

522263



### General Purpose Grinding Wheels

PROD. NO.	MOD. NO.	Size	Grade	Maximum RPM
522163	A675C	6" x 3/4" x 1"	<b>36</b>	4,138
522164	A675M	6" x 3/4" x 1"	<b>46</b>	4,138
522165	A675F	6" x 3/4" x 1"	<b>60</b>	4,138
522173	A610C	6" x 1" x 1"	<b>36</b>	4,138
522174	A610M	6" x 1" x 1"	<b>46</b>	4,138
522175	A610F	6" x 1" x 1"	<b>60</b>	4,138
522176	A610EF	6" x 1" x 1"	<b>80</b>	4,138
522263	A875C	8" x 3/4" x 1"	<b>36</b>	3,600
522264	A875M	8" x 3/4" x 1"	<b>46</b>	3,600
522265	A875F	8" x 3/4" x 1"	<b>60</b>	3,600
522273	A810C	8" x 1" x 1"	<b>36</b>	3,600
522274	A810M	8" x 1" x 1"	<b>46</b>	3,600
522275	A810F	8" x 1" x 1"	<b>60</b>	3,600

36 Grade = **Coarse**    46 Grade = **Medium**    60 Grade = **Fine**    80 Grade = **Extra Fine**

## 13-1/2" 3/4 HP 12 Speed Drill Presses

- Powerful 3/4 horse power motor
- 12 speed capability allows for a broad assortment of drilling applications
- Safety on/off switch
- Fully hinged belt and pulley cover and fully adjustable motor mount permit fast changes of spindle speed
- Worktable with quick release clamp rotates and tilts to 45° right and left
- Slots in worktable permit easy clamping of the work piece
- Positive depth setting mechanism uses a threaded rod and two lock nuts for accuracy
- Built-in work lamp with separate switch (bulb not included)

**Standard Equipment:** Drill chuck and key



PROD. NO. MOD. NO.	200225 JDP-13	200275 JDP-13F
<b>Swing</b>	<b>13-1/4"</b>	<b>13-1/4"</b>
<b>Type</b>	Bench Top	Floor Model
<b>Chuck Size</b>	5/8"	5/8"
<b>Drilling Capacity</b>	5/8"	5/8"
<b>Spindle Travel</b>	3-1/8"	3-1/8"
<b>Spindle Distance to Base</b>	24"	48-3/4"
<b>Spindle Distance to Table (Maximum)</b>	17-1/2"	31-1/2"
<b>Table Size (Diameter)</b>	11-3/8"	11-3/8"
<b>Table Tilt (Right and Left)</b>	0° - 45°	0° - 45°
<b>Spindle Taper</b>	MT2	MT2
<b>Column Diameter</b>	2-7/8"	2-7/8"
<b>Number of Spindle Speeds</b>	12	12
<b>Range of Spindle Speeds</b>	280-3,000 RPM	280-3,000 RPM
<b>Overall Height</b>	38-1/2"	61-5/8"
<b>Base size</b>	10" x 16-1/2"	10" x 16-1/2"
<b>Motor</b>	3/4HP, 1PH, 115/230V 5.2/2.6 Amps, Pre-wired 115V	3/4HP, 1PH, 115/230V 5.2/2.6 Amps, Pre-wired 115V
<b>Product Weight</b>	94 lb	107 lb
<b>Shipping Weight</b>	99 lb	112 lb





## DRILL PRESSES

### 17" 1 HP 16 Speed Drill Press

- Powerful 1 horse power motor
- Full 17" swing for easy drilling of larger work pieces
- 16 speed capability allows for a broad assortment of drilling applications
- Magnetic switch
- Fully hinged belt and pulley cover and quick adjust motor mount permit fast changes of spindle speed
- Worktable with quick release clamp rotates and tilts to 45° right and left
- Slots in worktable permit easy clamping of the work piece
- Positive depth setting mechanism uses a threaded rod and two lock nuts for accuracy
- Built-in work lamp with separate switch (bulb not included)

**Standard Equipment:** Drill chuck and key



**2** YEAR  
WARRANTY

PROD. NO.  
MOD. NO.

**200278**  
JDP-17F

Swing	<b>17"</b>
Type	Floor Model
Chuck Size	5/8"
Drilling Capacity	5/8"
Spindle Travel	3-1/4"
Spindle Distance to Base	48-3/8"
Spindle Distance to Table (Maximum)	28"
Table Size (Diameter)	13-3/4"
Table Tilt (Right and Left)	0° - 45°
Spindle Taper	MT2
Column Diameter	3-1/8"
Number of Spindle Speeds	16
Range of Spindle Speeds	220-3,380 RPM
Overall Height	64-1/2"
Base size	12" x 19-3/4"
Motor	1HP, 1Ph, 115/230V 8.5/4.25 Amps, Pre-wired 115V
Product Weight	176 lb
Shipping Weight	184 lb

## 22" 1-1/2 HP 12 Speed Drill Press

- Powerful 1-1/2 horse power motor
- Full 22" swing for easy drilling of larger work pieces
- 12 speed capability allows for a broad assortment of drilling applications
- Magnetic switch
- Fully hinged belt and pulley cover and quick adjust motor mount permit fast changes of spindle speed
- Worktable with quick release clamp rotates and tilts to 45° right and left
- Slots in worktable permit easy clamping of the work piece
- Positive depth setting mechanism uses a threaded rod and two lock nuts for accuracy
- Built-in work lamp with separate switch (use outdoor rated bulb, not included)

**Standard Equipment:** Drill chuck and key



PROD. NO.  
MOD. NO.

**200357**  
JDP-22F

Swing	<b>22"</b>
Type	Floor Model
Chuck Size	3/4"
Drilling Capacity	1-1/4"
Spindle Travel	4-1/2"
Spindle Distance to Base	49"
Spindle Distance to Table (Maximum)	29"
Table Size (Diameter)	16-1/2" x 18-3/4"
Table Tilt (Right and Left)	0° - 45°
Spindle Taper	MT3
Column Diameter	3-5/8"
Number of Spindle Speeds	12
Range of Spindle Speeds	180-4,200 RPM
Overall Height	69-1/4"
Base size	19-5/8" x 22-1/2"
Motor	1.5HP, 1Ph, 115/230V 10.0/5.0 Amps, Pre-wired 115V
Product Weight	353 lb
Shipping Weight	373 lb





2 YEAR WARRANTY

3 speed mechanical gearbox



2 YEAR WARRANTY

## METAL CUTTING BANDSAWS

### 4" x 6" 1/3 HP 3 Speed Belt Drive Bandsaw

- Sturdy cast iron saw frame and base
- 1/3 HP motor shuts off automatically when the workpiece is cut through
- Three speeds permit cutting of most materials including metal, plastic and wood
- Designed for horizontal and vertical cutting
- Vise permits mitre cuts to 45° and features a scale for accuracy
- Two wheels and handle permit easy movement
- Convenient shelf mounts under base

**Standard Equipment:** Blade; stand; wheels; shelf; vertical work table; material stop; vise

PROD. NO.	<b>222326</b>
MOD. NO.	JHVB-46
Capacity 90°	4-1/2" ● 4" x 6" ■
Blade Size	1/2" x 0.025" x 64-1/2"
Vertical Work Table	7" x 8"
Vise Tilts	45°
Blade Speeds (SFPM)	80, 120, 220
Motor	1/3 HP, 1Ph, 115 Volt, 1,725 RPM
Shipping Dimensions	40-1/2" x 12-3/4" x 15-3/4"
Net Weight (approx.)	134 lb
Shipping Weight (approx.)	140 lb

### 7" x 12" 1 HP 3 Speed Gearbox Bandsaw

- Heavy duty cast iron construction for accuracy and durability
- Three speed gear box replaces less efficient belt drive systems found on most comparable machines
- Horizontal cutting feed rate controlled by a fully adjustable hydraulic ram
- Coolant delivery system provides fast cutting while extending the service life of the blade and the saw
- Quiet cutting, rated within 70 decibels
- Easy cleaning with removable filter screen
- Automatic shut-off system stops the machine when the stock is cut through
- Quick action vise adjusts from 90° to 45° for mitre cutting
- Cuts up to 7" round stock and up to 7" by 12" rectangular stock
- Full 1HP, single phase motor
- Complete with four wheels for mobility

**Standard Equipment:** Blade; coolant system; material stop system; 4 wheels; vertical work table; enclosed stand; blade chip brush; quick action vise

PROD. NO.	<b>222332</b>
MOD. NO.	JHVG-712
Capacity 90°	7" ● 7" x 12" ■
Capacity 45°	4" ● 5" x 6" ■
Throat Depth	7"
Blade Size	3/4" x 0.032" x 93"
Vertical Work Table	9-1/2" x 10"
Vise Tilts	45°
Blade Speeds (SFPM)	125, 215, 270
Floor Space Required	49-1/2" x 17-1/2"
Motor	1 HP, 1Ph, 115/230 Volt Pre-wired 115V; 1,720 RPM
Shipping Dimensions	51" x 18" x 40"
Net Weight (approx.)	318 lb
Shipping Weight (approx.)	345 lb



## 9" x 16" 1-1/2 HP 4 Speed Belt Drive Bandsaw

- Designed for industrial use, this saw features a heavy duty steel and cast iron saw frame
- One piece cast iron saw bed
- Enclosed base, welded for strength
- Precision cast 13" blade wheels
- Coolant system includes: pump and reservoir; fully adjustable delivery nozzles at front and rear blade guides; coolant pick-up port in the drive wheel housing; quick-check gauge for coolant level
- Removable chip tray for easy cleaning
- Totally enclosed 1-1/2 HP fan cooled motor with 24 volt controls
- Four speed belt drive system
- Hydraulically controlled feed rate with micro adjust switch
- Automatic shut-off limit switch
- Blade guide system consists of ball bearing thrust roller, ball bearing blade guides and tungsten carbide slides
- Moveable left blade guide arm adjusts from 16" to 7" capacity
- Quick set vise adjusts for 90° to 45° angle cuts
- Material stop with 24" capacity
- Each machine factory tested and set

**Standard Equipment:** Variable pitch blade; blade chip brush; coolant system; tool kit; quick set vise and material stop

PROD. NO. MOD. NO.	222335 JHBS-916
Capacity 90°	9" ● 4" x 16" - 9" X 12" ■
Capacity 45°	6-1/2" ● 9" X 6-1/8" ■
Throat Depth	9"
Blade Size	1" x 0.032 x 119-1/2"
Blade Speeds (SFPM)	82, 132, 170, 235
Bed Height	25"
Floor Space Required	65" x 28"
Motor (TEFC)	1-1/2HP, 1PH, 230V complete with 24V control panel
Vise Swivels	45°
Wheel Diameter	13"
Net Weight (approx.)	627 lb
Shipping Weight	704 lb







# PULLERS







# GEAR PULLERS - HEAVY DUTY

Made of the highest quality drop forged  
Chrome Vanadium steel for professional use



770134



770135

## 2 or 3 Jaw Combination Gear Pullers

- Assemble with 3 jaws for maximum stability, or with 2 jaws where access is limited – 2 pullers in 1
- Jaws, yokes and forcing screw made of heat treated Chrome Vanadium steel for ultimate strength
- Reversible jaw design allows internal and external pulling
- Jaws grip tighter as pulling force increases
- All components hardened to HRC 42~45 for professional use
- Fine-threaded 440 CrV forcing screw allows precise control for damage free pulling
- Can be used with bearing separators

PROD. NO.	MOD. NO.	Reach	Spread	Capacity	Screw Length	Pitch	Jaw Thickness	Jaw Width
770132	JGP-3HD	<b>3-1/4"</b>	<b>4-3/4"</b>	2 tons	4.9"	3/8"-24 tpi	1/8, 1/4"	1/4, 7/16"
770133	JGP-4HD	<b>3-1/2"</b>	<b>7"</b>	5 tons	7"	9/16"-20 tpi	3/8, 3/4"	1/4, 5/16"
770134	JGP-6HD	<b>5-1/2"</b>	<b>7"</b>	5 tons	7"	9/16"-20 tpi	1/4, 5/16"	3/8, 3/4"
770135	JGP-8HD	<b>5-1/2"</b>	<b>9-1/2"</b>	5 tons	9"	11/16"-18 tpi	5/16, 11/32"	7/8"

CrV

## Hydraulic Gear Puller Set

770152 / JHGP-10S

- Jaws, yokes, bearing separator and ram made of heat treated Chrome Vanadium steel for ultimate strength
- Hydraulic ram requires no power - develops up to 10 tons of pressure with hand power only
- All components hardened to HRC 42~45 for professional use
- Includes twin and triple heads for assembling 2 jaw and 3 jaw pullers
- Includes 4-1/2" bearing separator
- Comes in a convenient blow mould storage case

Reach	Spread	Capacity	Pieces (total)
4"	10"	10 tons	22

**Contents:** Hydraulic Ram (1), 4" Puller Legs (3), 6" Puller Legs (3), 8" Puller Legs (3), Collar (1), Twin Head (1) Triple Head (1), End Cap (1), 2" Ram Extension (1), Yoke (1), 4-1/2" Bearing Separator (1), Main Rods (2), Extension Rods (2)



770152

## BEARING SEPARATORS - HEAVY DUTY

- Separator bodies made of heat treated Chrome Vanadium steel for maximum strength
- All components hardened to HRC 42~45 for professional use
- Separators have knife like edges to get behind bearings where regular gear puller jaws are too thick to grip
- Can be used with push or pull type gear pullers

### 12 Piece Set

770302 / JBS-12

Maximum Reach	Capacity	Forcing Screw	Hole Size
3"	5 tons	7", 9/16" x 10 tpi	3/8" x 16 tpi

**Contents:** 2-1/4" Bearing Separator (1), 3-1/2" Bearing Separator (1), Yoke (1), Forcing Screw (1), Main Rods (4), Extension Rods (4)



770302

### Open Stock

PROD. NO.	MOD. NO.	Capacity	Hole Size
770312	JBS-225	1-3/16" - 2-1/4"	3/8" x 16 tpi
770313	JBS-350	2-1/4" - 3-1/2"	3/8" x 16 tpi
770314	JBS-450	3" - 4-1/2"	1/2" x 16 tpi



### GEAR PULLERS

See page 291 in the Specialty Auto section for similar products





# SPECIALTY PULLERS

JET carries a complete line of Specialty Automotive pullers for every need.



H3341



H1921



H1901



H1903



H1905



H3560



H3565



H3566



H3562



# LUBRICATION & FLUID TRANSFER



**241**



## GREASE GUNS

### Lever Action

350151 / JLGG-14S



- Uses standard 14 oz. grease cartridge or can be bulk filled
- Rugged electro-static epoxy coated finish resists corrosion
- Deep knurling for non-slip grip
- Heavy duty steel barrel for long life
- Machined steel head protects hardened steel plunger
- V-handle posi-lock follower rod for sure grip and easy filling in any position
- Ideal for home, farm, maintenance and shop use
- Complete with 6" rigid pipe extension and coupler
- Delivers 1 gm/stroke or 1 oz./28 strokes
- Produces up to 6,000 PSI

### Lever Action – Heavy Duty

350152 / JLGG-14HD



Comes with rigid extension

- A premium, heavy duty grease gun built tough for the professional, industrial markets
- Added filler nipple allows three way loading; bulk, filler pump or standard 14 oz. cartridge
- Air bleeder valve easily purges unwanted air
- Variable stroke for working in confined areas
- Rugged electro-static epoxy coated finish resists corrosion
- Deep knurling for non-slip grip
- Heavy duty steel barrel for long life
- Die cast head protects hardened steel plunger
- T-handle posi-lock follower rod for sure grip and easy filling in any position
- Comfortable sure grip rubber handle makes pumping easy and convenient
- Complete with 6" rigid extension and heavy duty coupler
- A must for heavy maintenance, industrial, automotive and farm use
- Delivers 1 gm/stroke or 1oz./28 strokes
- Produces up to 10,000 PSI

### Pistol Grip – Heavy Duty

350155 / JPGG-14HD



Comes with rigid and flex extension

- Pistol grip design offers convenient one-handed operation
- Die cast head protects hardened steel plunger
- Uses standard 14 oz. grease cartridge or can be bulk filled
- Rugged electro-static epoxy coated finish resists corrosion
- Deep knurling for non-slip grip
- T-handle posi-lock follower rod for sure grip and easy filling in any position
- Includes 4" rigid pipe extension, 18" flexible hose and heavy duty coupler
- Delivers 0.50 gm/stroke or 0.70 oz./40 strokes
- Produces up to 5,000 PSI



### High Pressure / High Volume - Heavy Duty

350156 / JPGG-14HPHV

- Convenient lever mounted switch converts gun for high pressure or high volume use while maintaining one-hand operation
- Threadless barrel with quick connect lever allows for super-fast reloading with no danger of crossing threads
- Uses standard 14 oz. grease cartridge or can be bulk filled
- Complete with air bleeder and bulk loader valves
- Deep knurling for non-slip grip
- T-handle posi-lock follower rod for sure grip and easy filling in any position
- Includes 12" Heavy Duty flexible hose and coupler
- Delivers 0.90 gm/stroke or 1 oz./31 strokes
- Produces up to 7,000 PSI



### All-Weather Pistol Grip Grease Gun – Heavy Duty

350165 / JPPGG-14AW

- Specially designed to outperform in cold weather
- Large grease inlet with bleeder valve helps retain prime
- Double-lipped follower allows use with grease cartridge or bulk loading
- Pistol grip with compression spring for greasing with minimal effort
- Complete with 18" high pressure hose and professional 4-jaw coupler
- Delivers 1oz/40 strokes
- Produces up to 7,500 PSI



**NEW**

### 18 V Cordless Grease Gun – Heavy Duty

350166 / JCGG18

- Includes 2 long-life rechargeable 18 V batteries and 1 hour charger
- Complete with 42" high pressure flex hose and professional 4-jaw coupler
- Specs: 10 000 PSI; dispenses 2 oz/min
- Accepts standard 14oz cartridge, or can be bulk filled
- Includes durable plastic storage case and shoulder strap

**NEW**





Die cast head

Comes with rigid and flex extension



Pre-loaded with NLGI Grade 2 grease

## GREASE GUNS

### Single Shot Air Powered – Heavy Duty

350161 / JAGG-14P

- A premium heavy duty air powered grease gun for the most demanding professional user
- Intermittent action delivers one shot of grease for every pull of the trigger
- Added filler nipple allows 3 way loading; bulk, filler pump, or standard 14 oz. cartridge
- Heavy duty die cast aluminum head
- Precision honed barrel for fast action
- Air pressure 40-120 PSI at 1 cfm or greater
- T-handle posi-lock follower rod for sure grip and easy filling in any position
- Complete with male quick coupler air fitting
- Delivers 0.90 gm / shot or 1.30 oz./40 shots
- Produces up to 4,800 PSI
- Includes 6" rigid extension, 12" flexible hose and heavy duty coupler

### Continuous Flow Air Powered – Heavy Duty

350162 / CFAGG-14HD

- Automatic continuous flow of grease while trigger is depressed
- 40:1 Pump Ratio
- Minimum inlet air pressure 40 PSI to Maximum 120 PSI (2.7 to 10.3 bar)
- Develops up to 4,800 PSI pressure
- Added filler nipple allows 3 way loading; bulk, filler pump, or standard 14 oz. cartridge
- Air vent valve included for releasing air pockets
- Output per stroke 14 oz. per minute
- Lubricant up to NLGI #2 Grease
- Air Inlet 1/4-18 NPT
- Grease Outlet 1/8-27 UNPT
- Includes 6" rigid extension, 12" flexible hose and heavy duty coupler

### Pistol Grip - Mini Style - Heavy Duty

350171 / JMPG-16

- Convenient pull type trigger for easy one hand operation
- Die cast head
- Textured zinc plated finish for non slip grip
- Uses standard 3 oz. grease cartridges or can be bulk filled (grease not included)
- T-handle posi-lock follower rod for sure grip
- Complete with 4" rigid pipe extension and professional coupler
- Produces up to 3,500 PSI
- Delivers 0.40 gm/stroke or 0.60 oz./40 strokes

### Push Type - Mini Tool Box Style

350173 / JPTG-1

- Perfect tool box companion for lubrication of tools on the job
- Universal connector fits all standard fittings
- Comes pre loaded with NLGI grade 2 grease
- Can be re-filled
- Transparent barrel provides clear view of remaining grease
- Sealed design to prevent leakage



- Replacement whip hoses
- Polyimide inner tube with polyurethane outer tube, reinforced with highly tear resistant polyester

### High Pressure - Regular Style

- Heavy duty high pressure (11,600 PSI burst pressure)
- Working pressure 3,500 PSI

PROD. NO.	MOD. NO.	Length	Type	Thread
350181	JFH-12	<b>12"</b>	Flexible	1/8" NPT
350182	JFH-18	<b>18"</b>	Flexible	1/8" NPT

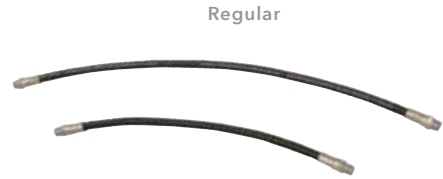

### High Pressure - Spring Style

- Fitted with heavy duty spring for added safety, strength and life
- Heavy duty high pressure (11,600 PSI burst pressure)
- Working pressure 3,500 PSI

PROD. NO.	MOD. NO.	Length	Type	Thread
350201	JFH-12SP	<b>12"</b>	Flexible	1/8" NPT
350202	JFH-18SP	<b>18"</b>	Flexible	1/8" NPT



### High Pressure - Super Heavy Duty

- Two layer construction consisting of polyamide inner tube with a tough polyurethane sheath, reinforced diagonally with high tear resistant polyester
- Extra large inner diameter is ideal for cold weather use
- Spring guard adds strength and safety
- For hand and air operated grease guns and control valves
- Working pressure 5,800 PSI
- Burst pressure 13,775 PSI

PROD. NO.	MOD. NO.	Length	Type	Thread
350215	JFH-12HP	<b>12"</b>	Flexible	1/8" NPT
350216	JFH-18HP	<b>18"</b>	Flexible	1/8" NPT





## GREASE GUN ACCESSORIES QUICK CHANGE COUPLER ADAPTERS

### 7 PC Quick Change Coupler Set

350213 / JQCC-7S

- Quick change feature snaps directly onto jaw type couplers - no need to remove hydraulic coupler to change accessories
- Instantly converts jaw type couplers for fine line greasing for access to confined areas
- Protective sleeve secures connection
- Ideal for applications where fittings are in hard-to-reach areas
- For hand operated grease guns
- **Set contains one of each depicted (except 350205)**

### Recessed Lube Adapter

350208 / JRLA-1

- 4" length, tip diameter 0.22"
- For push on greasing of fittings where obstruction will not allow use of regular coupler

### Right Angle Coupler

350211 / JRAC-2

- Working pressure 1,00 PSI
- Particularly useful in low height applications
- Polyurethane seal fits perfectly on grease fitting

### Needle Nose Adapter

350210 / JNND-2

- 1-1/2" needle length, diameter 0.156"

### Grease Injector Needle

350206 / JGIN-15

- Lubricates in extremely tight places including U-joints and sealed bearings
- Fits directly on jaw type couplers
- 18 gauge stainless steel
- 1-1/2" long
- With protective plastic cover

### Seal-Off Dispenser

350212 / JSOD-1

- Used for lubricating cars with grease plugs
- Oil and grease resistant rubber tip

### 90° Angle Lube Adapter

350209 / JALA-1

- 0.19" diameter

### Needle Nose Dispenser

350205 / JNND-1

- For dispensing fine line of grease
- Allows contact with flush or hard-to-reach fittings in inaccessible areas
- 1-1/2" needle length, diameter 0.156"
- 1/8" NPT threads

## GREASE GUN COUPLERS



- For hand operated grease guns
- Professional industrial quality

### 4 Jaw - Heavy Duty

350203 / JPDC-4

- Hardened body withstands high pressure without deformation
- Working pressure 6,000 PSI
- 1/8" NPT threads



350203

### Button Head - Heavy Duty

- Specifically designed to fit 5/8" and 7/8" button head fittings found on heavy machinery
- Metal seal resists wear

PROD. NO.	MOD. NO.	Threads	Working Pressure
350217	JBHC-58	1/8" NPT	6,000 PSI
350218	JBHC-78	1/8" NPT	7,500 PSI



350218



350217

### Right Angle - Heavy Duty

350204 / JRAC-1

- Unique design for greasing fittings in hard-to-reach areas
- Particularly useful in low height applications
- Polyurethane seal fits perfectly on grease fitting
- Working pressure 1,000 PSI
- 1/8" NPT thread



350204

### Swivel Type - Heavy Duty

350207 / JSGC-360

- Built in 360° swivel locks in eight positions
- Working pressure 7,000 PSI
- 1/8" NPT threads
- Fully hardened 3-jaw construction



350207

## GREASE GUN HOLDERS

### Grease Gun Holder

350185 / JGGH-1

- Conveniently mounts any 2-1/4" O.D. grease gun to almost any surface



350185

### Grease Gun Holder - Heavy Duty

350189 / JGGH-2HD

- Designed specifically for mounting on construction equipment, farm vehicles, tractor trailers and other vehicles subject to high vibration
- Heavy duty spring retains gun securely and allows easy removal and replacement
- Four mounting bolts for secure attachment
- Fits 2-1/4" and 2-1/2" barrel diameters



350189



## GREASE FITTINGS

- Conforms to SAE, DIN, BS and JIS standards
- EN-1A steel with zinc plating
- Heat treated to a minimum of HRC83



350259 / 350260



350263



350264

### Sets - Heavy Duty

PROD. NO.	MOD. NO.	Type	Pieces	Contents
350257	JGF-8S	SAE	8	2 each: 1/4" - 28 Straight, 1/8" - 27 Straight, 1/8" - 27 45°, 1/8" - 27 90°
350258	JGF-8M	Metric	8	2 each: M6 x 1 Straight, M6 x 1 45°, M6 x 90°, M8 x 1
350259	JGF-80S	SAE	80	15 x 1/4" - 28 Straight, 10 x 1/4" - 28 45°, 10 x 1/4" - 28 90°, 25 x 1/8" - 27 Straight, 10 x 1/8" - 27 45°, 10 x 1/8" - 27 90°
350260	JGF-80M	Metric	80	20 x M6 x 1 Straight, 10 x M6 x 1 90°, 15 x M8 x 1 Straight, 10 x M8 x 1 90°, 15 x M10 x 1 Straight, 10 x M10 x 1 90°
350263	JGFK-101	SAE	101	1/8"-27 NPT: 22 Straight, 5 x 30°, 10 x 45°, 10 x 65°, 10 x 90° 1/4"-28 SAE-LT: 22 Straight, 10 x 45°, 10 x 90° <b>350261</b> (JGFT-14) and <b>350262</b> (JGFT-18) fitting tools



350257 / 350258

### 40 PC SAE Stainless Steel Grease Fitting Set - Heavy Duty 350264 / JGFK-40SS

- Stainless steel fittings for use in marine and other corrosive environments
- CONTENTS:**
- 1/8"-27 NPT: 10 straight, 5x45°, 5x90°
  - 1/4"-28 SAE-LT: 10 straight, 5x45°, 5x90°



STRAIGHT  
350251 / 350254



45°  
350252 / 350255



90°  
350253 / 350256



**10 Packs - Heavy Duty**

PROD. NO.	MOD. NO.	Type	Pieces	Thread	Hex Size
350251	JGF-142800	Straight Fittings	10	1/4" - 28 SAE	5/16"
350252	JGF-142845	45° Fittings	10	1/4" - 28 SAE	3/8"
350253	JGF-142890	90° Fittings	10	1/4" - 28 SAE	3/8"
350254	JGF-182700	Straight Fittings	10	1/8" - 27 NPT	7/16"
350255	JGF-182745	45° Fittings	10	1/8" - 27 NPT	7/16"
350256	JGF-182790	90° Fittings	10	1/8" - 27 NPT	7/16"

**Grease Fitting Unblocker** 350265 / JFUT-100

- Opens clogged grease fittings and loosens hardened grease joints
- Tapping tool with a hammer forces a light viscosity oil into the fitting, breaking up and removing dirt and debris
- Excellent for maintaining bearings, control arms, king pins etc.
- Built-in hand guard for operator protection
- Complete with coupler and flex hose for reaching recessed fittings
- Includes 2 spare piston seals



350265

**4 Way Fitting Tools**

- Handy multi-purpose fitting tools
- Wrench, tap and extractor in one
- Removes worn and broken fittings, re-taps threaded holes, installs new fittings
- Works with straight and angled fittings

PROD. NO.	MOD. NO.	Application
350261	JGFT-14	<ul style="list-style-type: none"> <li>• Tap repairs 1/4"-28 SAE threaded holes</li> <li>• Wrench removes and installs 5/16" and 3/8" hex fittings</li> </ul>
350262	JGFT-18	<ul style="list-style-type: none"> <li>• Tap repairs 1/8"-27 NPT threaded holes</li> <li>• Wrench removes and installs 7/16" and 3/8" hex fittings</li> </ul>



350262



350261





## GREASE PUMPS

### Grease Gun Filler Pump

350158 / JGFP-03

- Zinc die cast head and adjusting flange
- 18" zinc plated pump body
- Epoxy coated, corrosion resistant 12" drum cover
- All steel foot valve
- Fits 25 - 50 lb / 5 gallon pails
- Designed to load bulk or combination grease guns
- Delivers 28 gms on 1oz./stroke
- Suitable for use with light and medium density grease

### 50:1 GREASE PUMPS

- Designed for everyday use in shops, factories and maintenance departments for quick and efficient dispensing of grease
- All units dispense 27 ounces per minute. Simply connect to your air system, pull the trigger and let these powerful pumps do the work
- Each unit comes with 18" whip hose/coupler, control valve, 4 meters of hose, drum cover and follower plate



### 50 lb Air Operated Grease Pump Kit - Heavy Duty

350306 / JAGP-25

- 50:1 Air Operated Grease Pump (25-50 lb container)
- Requires 70-115 PSI operating pressure
- Pumps up to 1.76 lb per minute (27 ounces)
- 82 dB noise level
- 13' delivery hose
- 12-13/64" drum cover
- 10-3/8" follower plate
- Control valve
- Shipping Weight: 23 lb (10kg)



### 120 lb Air Operated Grease Pump Kit - Heavy Duty

350307 / JAGP-120

- 50:1 Air Operated Grease Pump (120 lb container)
- Requires 70-115 PSI operating pressure
- Pumps up to 1.76 lb per minute (27 ounces)
- Comes with 4 wheel roll around cart
- 82 dB noise level
- 13' delivery hose
- 15" drum cover
- 14-1/2" follower plate
- Control valve
- Shipping Weight: 38 lb (17 kg)



## Control Valve

350311 / JAPG-CV

- Premium quality, top of the line grease control valve for use with air operated equipment
- Provides continuous grease flow with trigger fully depressed
- Inlet thread: 1/4" NPTF



## Booster Grease Control Valve

350312 / BGCV-1

- Heavy duty grease control valve with built-in pressure boost mechanism
- Repeated actuation of handle boosts line pressure from 6,000 PSI up to 10,000 PSI
- Provides continuous flow with handle fully depressed
- Extremely useful for unblocking clogged fittings
- Complete with 6" rigid extension and 4 jaw heavy duty coupler
- Inlet thread 1/4" NPTF



## 360° Swivel

350391 / JAGP-SW

- 1/4"(M) x 1/2"-27(M)
- Installed between the delivery hose and grease control valve allowing greater mobility and control of the grease control valve
- Heavy duty steel construction with ball bearings for smooth operation and unrestricted movement
- Swivel joints are hardened for durability and greater wear resistance
- Maximum working pressure - 6,000 PSI





## WATER, CHEMICAL AND OIL PUMPS

### Polyethylene Siphon Pumps

- Easy to use pumps siphon liquids to lower levels automatically once started
- 6 to 7 strokes of the bellows primes pump requiring no further operation
- Vent cap stops siphoning when opened
- Bellows can be continuously operated to pump liquids to higher levels than pump is installed
- Complete with flexible discharge hose
- **Recommended use:** water-based fluids, detergents, waxes, soaps, antifreeze, mild acid solutions, and other lightweight non-flammable liquids
- **Do not use with:** concentrated acids, acetone, benzene, fuels, fluids incompatible with wetted components, or liquids above 60°C (140°F)
- Wetted components: polyethylene

PROD. NO.	MOD. NO.	Discharge	Bung Size	Fits	Wetted Components	Discharge Hose Length
350110	JPSP-2	2 GPM (6.5 LPM)	1-1/2"	5 gal / 5-20 l pails	Polyethylene	21-1/2"
350111	JPSP-5	5 GPM (17.5 LPM)	2"	55 gal / 205 l drums	Polyethylene and Polypropylene	46-1/2"
350112	JPSP-7	7 GPM (21 LPM)	2"	55 gal / 205 l drums	Polyethylene and PVC	47-3/4"



### Chemical Pump - Nylon Body

350109 / JNCP-14

- Self-priming vertical lift pump
- Fits 15 - 55 gallon drums
- Delivers 14 oz. per stroke
- **Recommended use:** lacquer thinners, acetone, MEK, antifreeze, detergents, windshield washer fluids, mild acids, weed killer, water and glycerine
- **Do not use with:** strong acids or gasoline
- Wetted components: nylon, polypropylene, stainless steel and PTFE

### Chemical Pump - Polypropylene Body

350108 / JPCP-14

- Self-priming vertical lift pump
- Fits 15 - 55 gallon drums
- Delivers 14 oz. per stroke
- **Recommended use:** antifreeze, detergents, windshield washer fluid, mild acids and glycerine
- **Do not use with:** water, strong acids, lacquers, acetone and gasoline
- Wetted components: polypropylene, steel, Viton<sup>®</sup>

## Plastic Lever Pump

350113 / JPLP-100

- Lever action barrel pump designed for use with high viscosity fluids
- Special design makes pumping thick liquids easier reducing operator fatigue
- Built in 2" bung adapter with lock nut allows pump handle to be positioned conveniently
- Air vent cap stops siphon action
- Delivers 500 ml per stroke
- For use on 15 - 55 gallon (50 - 205 litre) drums
- Complete with 6' corrugated discharge hose
- **Recommended use:** water-based fluids, detergents, waxes, soaps, antifreeze, windshield washer fluid, hydraulic oils, lubricants, pesticides and herbicides, Adblue®, Urea, DEF and other non-flammable liquids
- **Do not use with:** concentrated acids, acetone, benzene, fuels, thinners, solvents or fluids incompatible with wetted components
- Wetted components: polyacetal, polypropylene, polyethylene, PVC, Viton®



## OIL AND FUEL PUMPS

### Oil Cans

- Industrial quality
- Brass pump
- Electro-static, corrosion resistant epoxy coating
- Complete with flex hose and rigid spout

### Brass Pump Oil Cans

PROD. NO.	MOD. NO.	Capacity
350121	JOC-180	6 oz. / 180 ml
350122	JOC-300	10 oz. / 300 ml
350124	JOC-500	16 oz. / 500 ml
350125	JOC-700	24 oz. / 700 ml

350125



All models complete with both flex and rigid spouts



## OIL AND FUEL PUMPS

### Barrel Pump - Lever Action - Heavy Duty

350105 / JLBP-01

- Suitable for use with all oil based fluids
- Fits 15 - 55 gallon drums
- Rugged epoxy coated pump assembly
- Tough all steel foot valve and piston valve
- Delivers 300 ml or 10 oz. / stroke
- Complete with 2 piece draw tube

### Bucket Pump - Lever action - Heavy Duty

350106 / JLBP-02

- Suitable for transfer of transmission, differential and heavier oils
- Delivers 16 oz. / stroke
- Zinc die cast head and adjustable flange
- Fits 25 - 50 lb / 5 gallon pails
- Epoxy coated, corrosion resistant 12" drum cover
- 18" zinc plated pump body
- Complete with 48" fuel resistant soft PVC hose with nozzle

### Suction Gun

350157 / JSGG-18

- Rugged 18 oz. capacity suction gun for draining and filling differentials, clutches and transmissions
- Does not require priming
- Heavy duty steel barrel for long life
- Electro-static epoxy coated finish resists corrosion
- Deep knurling for non-slip grip
- T-handle posi-lock follower rod for sure grip
- Complete with flexible vinyl hose
- For use with any non-corrosive lubricants

### Brass Transfer Pump

350159 / JBTP-100

- Portable hand pump for quick and easy transferring or evacuating of a wide variety of media
- Non-corroding premium brass construction
- Self-priming
- Complete with 24" of 1/2" discharge hose and 40" of 1/4" suction hose
- Can be used to drain oil or transmission fluids through the dipstick hole - ideal for boats
- Transfer fluids from one container to another without lifting either
- Pumps 3.2 oz. (100ml) per stroke
- Wetted components: brass, neoprene



## Barrel Pump - Rotary - Heavy Duty

350103 / HRP-25

- Sturdy cast iron body with precisely machined cast iron vanes for better draw and smoother delivery
- Hi-Nitrile rubber pump seals
- Delivers 5 litres or 1.30 gallons per 20 revolutions
- Dual directional operation – pumps in either direction
- **Recommended use:** diesel, kerosene, heating oils, motor oils, lubrication oils (up to SAE 90) and other non-corrosive media
- **Do not use with:** gasoline, antifreeze, solvents, acids or water based media
- Comes with suction tube, 2" cast iron bung nut and steel discharge spout

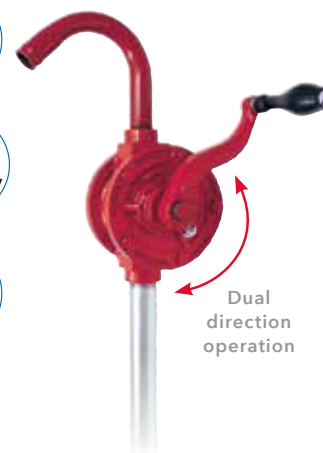

Dual direction operation

## Plastic Rotary Pump

350114 / JPRP-200

- Rotary barrel pump designed for use with media which cannot be pumped with cast iron or steel pumps
- Glass filled polypropylene body with Ryton® vanes, Viton® seals and stainless steel hardware for maximum resistance to chemicals
- Strainer fitted on suction tube prevents contaminants from entering pump
- Delivers 1 litre per 4 turns
- Includes 2" threaded bung adapter
- For use on 15 - 55 gallon (50 - 205 litre) drums
- **Recommended use:** water-based fluids, antifreeze, Adblue®, urea, DEF, benzene, detergents, glycerine, acids, chemicals, oils, diesel, kerosene
- **Do not use with:** acetone, lacquer, mineral oils, solvents, turpentine, gasoline or fluids incompatible with wetted components
- Wetted components: polypropylene, Ryton®, Viton®, stainless steel



## Litre Stroke Pump

350115 / JLSP-100

- Designed to dispense exact amounts of petroleum based fluids
- Adjustment screw allows pump to be set to deliver 1 litre or 1 quart per stroke
- Rack and pinion mechanism is very precise; ideal for applications requiring metered delivery
- Spring loaded drain-back tube returns overflow to the drum via the suction tube
- Handle can be padlocked for security
- Lock nut allows outlet to be positioned in any direction
- Complete with 2" bung adapter
- For use on 15 - 55 gallon (50 - 205 litre) drums
- **Recommended for:** gear and lube oils, petroleum based fluids, diesel fuel, kerosene
- **Do not use with:** water based, corrosive fluid, gasoline or liquids incompatible with wetted components
- Wetted components: steel, aluminum, nitrile rubber and acetal





## FUEL AND GASOLINE PUMPS



### Rotary Fuel Pump

350116 / JRF-10

- Industry standard for rotary pumps
- Designed for severe use in extreme weather conditions
- Solid cast iron body CNC machined to exacting tolerances
- High quality sintered powder metal 3 vane rotor operates in a highly finished pumping chamber
- Non-wearing graphite vanes and graphite seal allows pumping of a wide variety of fluids including those with up to 15% ethanol
- Discharges up to 10 GPM (38 LPM)
- Complete with 2" bung adapter and telescopic suction tube with strainer
- For use on 15 - 55 gallon (50 - 205 litre) drums
- **Recommended use:** gear and lube oils, petroleum based fluids, diesel fuel, kerosene and gasoline
- **Do not use with:** water based, corrosive fluids or fluids incompatible with wetted components
- Wetted components: cast iron, steel, graphite, paper, polypropylene

### Rotary Fuel Pump Kit

350117 / JRF-10K

- Industry standard for rotary pumps
- Designed for severe use in extreme weather conditions
- Complete with 8' anti-static discharge hose and non-sparking aluminum nozzle and nozzle holder for re-fueling operations
- Solid cast iron body CNC machined to exacting tolerances
- High quality sintered powder metal 3 vane rotor operates in a highly finished pumping chamber
- Non-wearing graphite vanes and graphite seal allows pumping of a wide variety of fluids including those with up to 15% ethanol
- Discharges up to 10 GPM (38 LPM)
- Complete with 2" bung adapter and telescopic suction tube with strainer
- For use on 15 - 55 gallon (50 - 205 litre) drums
- **Recommended for:** gear and lube oils, petroleum based fluids, diesel fuel, kerosene and gasoline
- **Do not use with:** water based, corrosive fluid, or fluids incompatible with wetted components
- Wetted components: cast iron, steel, graphite, paper, polypropylene

### 3:1 High Volume Rotary Fuel Pump

350118 / JRFP-300

- Geared rotary barrel pump turns rotor 3 times for each turn of the handle
- Dispenses up to 55 gallons (205 litres) in just 3 minutes
- Ideal for use where volume fuel dispensing is required
- Die cast aluminum pump body with die cast zinc rotor and vanes
- Built-in nozzle holder
- Handle can be locked for security
- Complete with 6' fuel resistant discharge hose
- Complete with 2" bung adapter and 3 piece threaded tube
- For use on 15 - 55 gallon (50 - 205 litre) drums
- **Recommended use:** gasoline, diesel fuel, and kerosene
- **Do not use with:** water based or corrosive liquids, solvents, acids, alkalis or fluids incompatible with wetted components
- Wetted components: aluminum, zinc, steel, NBR and PVC Nitrile

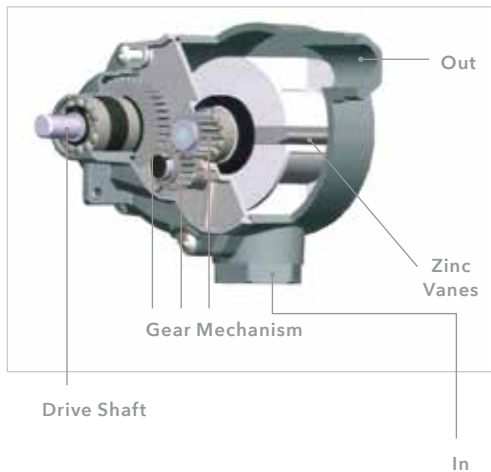

### Diaphragm - Litre Stroke - Heavy Duty

350107 / JDDP-1000

- High volume double action pump delivers on both strokes for fast fuelling
- Delivers 1 litre per cycle or 1 gallon / 5 strokes
- Fits 15 - 55 gallon drums
- Die cast aluminum construction
- Stainless steel piston and fuel resistant diaphragm
- Extra heavy duty steel handle with security locking latch
- Complete with 2" bung adapter, 8' discharge hose and telescoping suction tube
- **Recommended use:** gasoline, diesel fuels, fuel oil, motor oil
- **Do not use with:** corrosive liquids, solvents, alkalis, or fluids incompatible with wetted components
- Wetted components: aluminum, steel, stainless steel, polyacetal, NBR



# OIL DRAINS



## 24 US Gallon (90 Litre) Waste Oil Drain - Heavy Duty

350511 / JOIDR90

- Large 90 litre steel recovery tank
- 78" long drainage hose
- Tank mounted oil-level sight gauge
- Convenient tool tray
- 16" diameter collection funnel holds 18 litres of oil
- 23" diameter collection funnel adapter included to expand oil catch area
- Shut off valve between collection funnel and tank allows fluid inspection prior to draining oil
- Uses air to pressurize tank, allowing quick and easy fluid evacuation (maximum 7 PSI)
- Pressure regulator included
- Adjustable bowl height from 40" to 79" high
- Uses gravity to drain waste oil from engines, gear boxes, and differentials
- Shipping weight: 60 lb (27 kg)



## 18 US Gallon (68 Litre) Waste Oil Drain

350512 / JOIDR68GD

- 68 litre steel recovery tank
- 8' drainage hose doubles as an oil level sight gauge
- 14" metal collection funnel holds 10 litres of oil
- Shut off valve between funnel and tank allows fluid inspection prior to draining oil
- Uses air to pressurize tank, allowing quick and easy fluid evacuation (maximum 10 PSI)
- Pressure regulator included
- Adjustable bowl height from 46 to 75"
- Uses gravity to drain waste oil from engines, gear boxes and differentials
- Shipping weight: 58 lb (26 kg)



**17 US Gallon (64 Litre) Low Profile Polypropylene Oil Drain** 350514 / JOIDRLP

- Ideal for draining oil where a pit or hoist is not available
- 17 US Gallon tank with integrated baffle captures oil and minimizes spillage during transport
- Convenient rotary hand pump for fast evacuation to large oil collection tanks
- Large metal screen keeps foreign matter out of recovery tank
- Long steel handle eases moving and positioning of drain
- Shipping Weight: 46 lb (21 kg)



**15 US Gallon (56 Litre) Low Profile Steel Tank Oil Drain** 350515 / JOIDRLPM

- Ideal for draining oil where a pit or hoist is not available
- 15 US Gallon tank with integrated baffle captures oil and minimizes spillage during transport
- Convenient rotary hand pump for fast evacuation to large oil collection tanks
- Large metal screen keeps foreign matter out of recovery tank
- Long steel handle eases moving and positioning of drain
- Shipping Weight: 46 lb (21 kg)



**17 US Gallon (64 Litre) Low Profile Polypropylene Antifreeze Drain** 350520 / JOIDRLPAF

- Ideal for draining antifreeze where a pit or hoist is not available
- 17 US Gallon tank with integrated baffle captures antifreeze and minimizes spillage during transport
- Convenient rotary hand pump for fast evacuation to large collection tanks
- Aluminum pump body specifically designed to pump corrosive antifreeze
- Large metal screen keeps foreign matter out of recovery tank
- Long steel handle eases moving and positioning of drain
- Shipping Weight: 46 lb (21 kg)



**9L Manual Fluid Extraction Pump** 350551 / JMPE-9

- Quickly and efficiently evacuates a multitude of fluids, including engine oil, transmission fluids, gear oil, and brake fluid
- Includes one brake line flex hose, two dipstick hoses, and a line clearing tool
- Features a durable rust and corrosion resistant polyethylene construction
- Quick-drain pour spout

**NEW**







## DRUM HANDLING



### Drum Wrench - Aluminum Handle

350214 / JADW-1

- Designed to fit perfectly onto most 2" and 3/4" drum plugs
- Made of cast aluminum for strength and safety
- Will not cause sparks
- Hardened and tempered



351003

### Drum Dollies

- Heavy gauge steel for professional use
- Powder coated finish
- 5 and 16 gallon models with adjustable clamp bolt
- 16 and 55 gallon models complete with cast iron casters

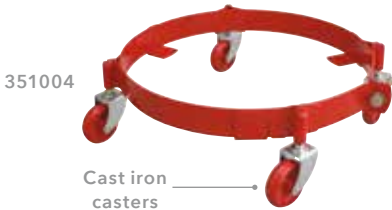

351004

Cast iron  
casters

PROD. NO.	MOD. NO.	Application	Wheels	Load Limit	Diameter
351003	JDD-5	<b>5 gallon drums</b>	Resin	200 lb	10-1/4 - 11-1/4"
351004	JDD-16	<b>16 gallon drums</b>	Super Heavy Duty Cast Iron	200 lb	13-1/2 - 14-1/4"
351005	JDD-55	<b>55 gallon drums</b>	Super Heavy Duty Cast Iron	450 lb	23"

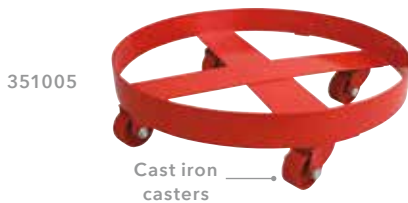

351005

Cast iron  
casters



### Drum Cradle

351011 / JDC-55

- Tilting drum cradle moves, rotates, tips and stores 55 gallon drums with ease
- Self storing lever bar
- Powder coated finish
- Flat packed for easy shipping
- 2-1/2" non-sparking wheels
- Load limit: 600 lb (270 kg)

**JET**



# SPECIALTY AUTOMOTIVE





## BRAKE REPAIR TOOLS

### Brake Adjusting Tool - Universal

H1085

- Ground and tapered for easy access to most applications
- Lustre plated for rust protection
- Blade width: **5/8"**
- Overall Length: **9"**

### Brake Adjusting Tool - Short

H1107

- This short length tool is popular as it gets into many tight spots found on today's cars
- Curved and ground for universal use
- Lustre plated for rust protection
- Blade width: **1/2"**
- Overall Length: **7"**

### Brake Shoe Retaining Spring Tool

H1096

- Dual size for dish type washers
- Used for removing the dish type washer on brake shoe hold down spring
- Knurled cup securely grips washer
- Notched for washer with ears
- Fits many imports with smaller hold down springs
- Plastic handle
- Bright lustre plated
- Range: **5/8 - 7/8" diameter washers**

### Brake Spring Pliers

H1103

- Removes and installs brake springs on majority of cars and trucks
- Forged from alloy steel and heat-treated for long wear
- Designed with narrow points for inline pull on the springs
- Equipped with special Bendix® socket on one end
- Overall length: **13"**

### Rear Disc Brake Piston Tool

H3070

- Designed to rotate the rear parking brake piston back into the caliper cylinder when replacing worn brake pads on vehicles equipped with four wheel disc brakes
- Will work on most Ford®, Chrysler®, some GM® models, and some imports



## Tube Bender - Heavy Duty

H1278

- Bend thin wall tubing 360° with this heavy duty bender
- For use in automotive, plumbing, heating, refrigeration and marine applications
- Range: **1/8" - 1/2" O.D. tubing**



## Pliers Type Tube Bender - Heavy Duty

H3342

- Bends copper or steel tubing without kinking or collapsing
- Comes with two roller adapters
- Bends **3/16", 1/4", 5/16", 3/8"** tubing

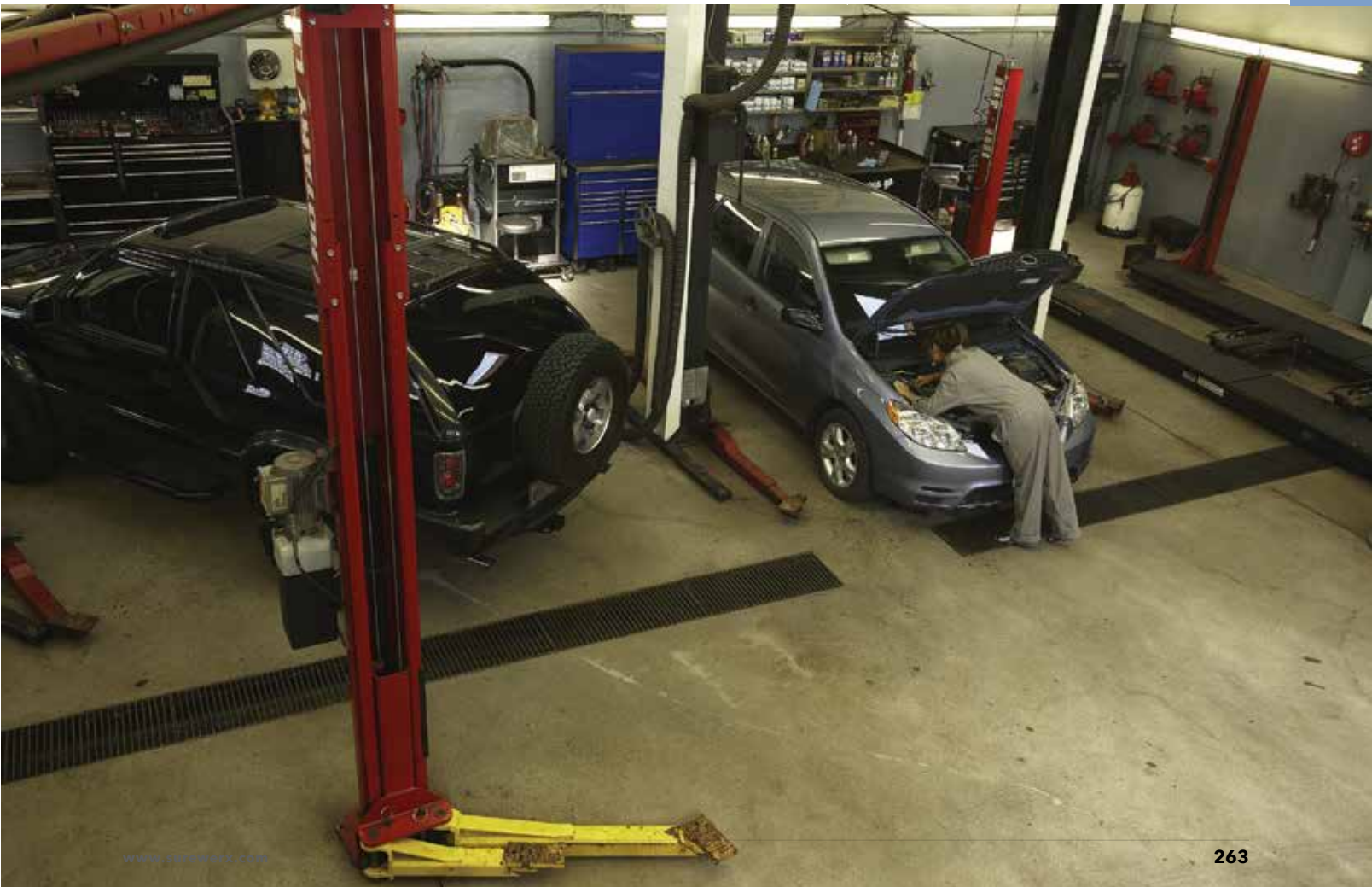

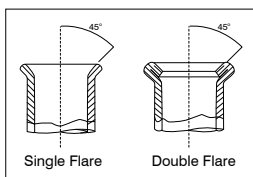

## FLARING TOOL KITS

### Double Flaring Tool Kit SAE

H1120

- Built to provide the necessary pressure to double flare steel brake tubing
- Will double and single flare both copper and steel tubing
- Double flare adapters provide for 3/16, 1/4, 5/16, 3/8 and 1/2" tubing
- Alloy steel swivel is heat treated, ground, and chromed to reduce compression friction
- Yoke and bar is forged and tempered for added strength

#### Kit Includes:

**H1120A** Double flare adapter 3/16"

**H1120E** Double flare adapter 1/2"

**H1120B** Double Flare adapter 1/4"

**H1120F** Bar assembly

**H1120C** Double Flare adapter 5/16"

**H1120G** Yoke and bolt assembly

**H1120D** Double flare adapter 3/8"

**H1120H** Wingnut

### Double Flaring Tool Kit - Metric

H1121

- Built to provide the necessary pressure to double flare steel brake tubing
- Will double and single flare both copper and steel tubing
- Double flare adapters provide for 4.75, 5, 6, 8, 10 mm tubing
- Alloy steel swivel is heat treated, ground, and chromed to reduce compression friction
- Yoke and bar is forged and tempered for added strength

#### Kit Includes:

**H1121A** Double flare adapter 4.75 mm

**H1121E** Double flare adapter 10 mm

**H1121B** Double flare adapter 5 mm

**H1121F** Bar assembly

**H1121C** Double flare adapter 6 mm

**H1121G** Yoke and bolt assembly

**H1121D** Double flare adapter 8 mm

**H1121H** Wingnut

### Double Flaring and Cutting Tool Kit

739181 / JTFK-100

- Includes JTC Tubing Cutter, JFT-100 Tool and Double Flaring Inserts for 3/16, 1/4, 5/16, 3/8, 7/16, 1/2 and 5/8" tube
- Provides automotive type double flare or use without inserts for 45° flare
- Cuts up to 1-1/8" (30 mm) tube
- Complete with blow mould storage case
- Replacement Double Flaring Dies:

**3/16" - H1120A**

**7/16" - H1120J**

**1/4" - H1120B**

**1/2" - H1120E**

**5/16" - H1120C**

**5/8" - H1120K**

**3/8" - H1120D**



## ISO Bubble Flaring Tool Kit

H1502

- Front wheel drive cars and light trucks, both foreign and domestic, are installing ISO sized steel brake lines with the ISO flare. This is different from the standard double flare
- Accomplishes the ISO flare without removing the brake line from the vehicle, and it has the strength to withstand the pressure necessary fo flare mild steel tubing (1.0 mm wall thickness) used on the front wheel drive brake line
- Yoke is made of a heat treated, alloy steel drop forging, with a special patented center screw
- Bar assembly is hardened and will hold up under repeated use and produces a smooth, consistent flare
- Kit is complete with flaring tool, four special adapters, a chamfering tool and a combination wrench and height gauge

### Kit Includes:

<b>H1502A</b> Adapter 4.75 mm	<b>H1502E</b> Bar assembly
<b>H1502B</b> Adapter 6 mm	<b>H1502F</b> Yoke assembly
<b>H1502C</b> Adapter 8 mm	<b>H1502G</b> Reamer
<b>H1502D</b> Adapter 10 mm	<b>H1502H</b> Wrench

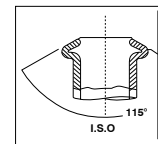

## BRAKE REPAIR TOOLS

### Deluxe Vacuum Pump with Bleeder Kit

H3502

- Checks vacuum operated components on all vehicles including distributor advance mechanism, heater and air conditioning baffles, PCV and EGR valves, headlight cover doors, transmission modulators and more
- Allows you to bleed brake fluid by yourself
- **Kit Includes:** Fluid resistant valve pump, easy reading gauge head, reservoir jar, transfer and storage lids, rubber cup adapter, two 2' lengths of tube, brake bleeding adapters for most vehicles
- Replacement Parts:

<b>H3502-10</b> Gauge head	<b>H3502-12</b> Adapter kit
<b>H3502-11</b> Bleeder cup and caps	<b>H3502-13</b> Pump seal kit



### 11 PC Disc Brake Caliper Tool Set

H3444

- Used to install new rear brake pads by winding the piston back into the caliper
- May be used on or off the vehicle
- Piston retraction is completed smoothly without damaging the piston or boot
- Includes 9 adapters for use on 2 and 4 wheel rear disc brake assemblies
- Designed for use with Mercedes®, BMW®, Volkswagen®, GM®, Audi®, Ford®, Honda®, Subaru®, Mazda®, Nissan®, Mitsubishi®, Toyota®, Land Rover®, and 4 wheel drive vehicles
- Comes in convenient blow mould storage case





## CYLINDER HONES – ABRASIVE



### Small Brake Cylinder Hone (1/2" – 2-1/2" Range)

H1841

- For sub-compact cars, including imports
  - For cylinder bores 1/2" to 2-1/2" diameter
  - Offers fast, easy cutting with high or low speed drill
  - Self-aligning, self-centering flex joint drive
  - Adjustable tension
- Replacement Stones:
- **H1841A** Set of 2 : Medium, **220 Grit**, Stone Length 1-1/8"



### Brake Cylinder Hone (3/4" – 2-1/2" Range)

H1844

- Designed for fast accurate deglazing of cylinders
  - Operated by any 1/4" - 1/2" electric drill
  - Powerful arm design keeps the abrasives accurately in line
  - Spring tension adjusting nut for positive cutting action at all speeds
  - Full range **3/4" - 2-1/2"** capacity equipped with three 220 grit stones recommended for ring seating
- Replacement Stones:
- **H1844B** Set of 3 : Medium, **220 Grit**, Stone Length 1-1/8"



### Small Engine Hone (1" – 3" Range)

H1864

- Flexible drive shaft permits easy access to all cylinders
- Cone expansion adjusts hone to cylinder wall with uniform pressure
- Adjustable spring tension to select desired pressure
- Fits standard 1/4" or 3/8" drill
- Range: **1" - 3"** cylinder diameter
- No extensions required
- Supplied with 180 grit 2" stones recommended for quick, positive seating of all piston rings
- Replacement Stone Kit: **H1864C** Set of 3 : **180 Grit**, 2" Long
- Optional Stone Kit: **H1844E** Set of 3 : **220 Grit**, 2" Long



### Engine Hone (2 – 7" Range)

H1843

- Designed for fast accurate deglazing of cylinders
  - Operated by any 1/4" - 1/2" electric drill
  - Powerful arm design keeps the abrasives accurately in line
  - Spring tension adjusting nut for positive cutting action at all speeds
  - Full range **2" - 7"** (51-178mm) capacity equipped with three 220 grit stones recommended for ring seating
- Replacement Parts:
- **H1843A** Replacement Stones Set of 3 : Medium, **220 Grit**, 4" Long
- Accessory Stone Sets:
- **H1843E** Set of 3: Coarse, **100 Grit**, 4" Long
  - **H1843F** Set of 3: Fine, **400 Grit**, 4" Long

**Wheel Bearing Packer** **H3047**

- For use with grease guns
- Works on all wheel bearings having a minimum I.D. of 1/2" to a maximum O.D. of 5"
- Height of 1/4" - 2"
- Place bearing between cones and tighten. Old grease is forced out as new grease is pumped in under pressure
- Use hand or power equipment



**10 PC Bearing Race and Seal Driver Set** **H3437**

- Inserts bearing race and seals quickly, straight and without damaging both race and axle housings on the first try
  - Collars fit most standard wheel bearing sizes
  - Comes in convenient blow mould storage case
- Set includes:**
- 9 Disc Sizes: **1.565, 1.750, 1.965, 2.325, 2.470, 2.555, 2.830, 2.995, 3.180"**
  - 1 heavy duty driver handle



**18 PC Universal Driver Set** **H3538**

- Includes most popular size drivers for proper installation of seals, bearings, bushings
  - Ensures even distribution of force to all areas and prevents cocking
  - Comes in convenient blow mould storage case
- Set includes:**
- 12 Drivers: **5/8, 3/4, 7/8, 1, 1-1/8, 1-1/4, 1-3/8, 1-1/2, 1-5/8, 1-3/4, 1-7/8, 2"**
  - 1 handle, 4 cap screws, 1 hex key





## FRONT WHEEL DRIVE AXLE NUT TOOLS

### 7 PC Axle Nut Socket Set

H3533

- Sockets made of high quality Chrome Molybdenum steel for best performance and life
- Sockets are 1/2" drive and are extra long in order to adequately access FWD spindle nuts
- May be used with air and electric impact wrenches, ratchets, flex and breaker bars and with torque wrenches
- Comes in convenient blow mould storage case
- Includes: **29, 30, 32, 34, 35, 36 and 38 mm**



### Axle Nut Sockets - Open Stock

H3149	<b>29 mm</b>	Serves late model GM*, Ford* and Asian imports including the Escort* and Fiesta*
H3150	<b>30 mm</b>	Serves GM* "A", "J", "N" and "X" body cars and some Asian imports
H3151	<b>32 mm</b>	Serves late model Honda* and Chrysler* cars
H3152	<b>34 mm</b>	Serves late model GM*, Buick*, Cadillac*, Chevy*, Oldsmobile* and Pontiac* cars
H3308	<b>35 mm</b>	Serves many late model GM* cars
H3153	<b>36 mm</b>	Serves GM* "E" style cars
H3309	<b>38 mm</b>	Serves a variety of full size vehicles including many SUV's

## TRUCK WHEEL BEARING LOCKNUT SOCKETS

- Specially designed sockets used for the quick and easy removal of truck wheel bearing locknuts
- Made from high quality steel which resists "round out"
- Available in 6 point hexagon, 8 point octagon and special "rounded" shape for Dana® axles
- All sockets are 3/4" drive
- For use with manual ratchets, flex and breaker bars, and torque wrenches

### 6 Point Hexagon Style

H2150	<b>2-3/32"</b>	H2179	<b>2-7/8"</b>
H2169	<b>2-1/4"</b>	H2155	<b>3"</b>
H2151	<b>2-3/8"</b>	H2157	<b>3-1/4"</b>
H2170	<b>2-1/2"</b>	H2159	<b>3-1/2"</b>
H2171	<b>2-5/8"</b>	H2186	<b>3-3/4"</b>
H2153	<b>2-9/16"</b>	H2161	<b>3-7/8"</b>
H2172	<b>2-3/4"</b>	H2163	<b>4"</b>
		H2164	<b>4-1/8"</b>

### Special Rounded Hexagon Style

H2177

- This special "rounded" hex truck wheel bearing locknut socket is used on Dana® axles
- **2-9/16"**

### 8 Point Octagon Style

H2158	<b>3-1/4"</b>	H2176	<b>3-13/16"</b>	H2166	<b>4-3/8"</b>
H2188	<b>3-3/4"</b>	H2162	<b>3-7/8"</b>	H2168	<b>4-7/8"</b>



**Caution:** Do not use with any air or electric impact tools

## 6 Pin 2-5/8" Outer Style Locknut Socket

H1486

- 1978 to current Ford® 3/4 ton vehicles
- 1973 to 1981 GM® 3/4 ton vehicles



## 4 Pin 2-1/4" Inner Style Locknut Socket

H3406

- 1978 to current 1/2 ton Chevrolet® and GMC®
- 1966 to current Bronco®, Blazer® and Scout®
- 1959 to current Ford® F150-250 series
- 1969 to current Dodge® 1/2 ton vehicles



## 4 Pin 2-3/4" Outer x 1-9/16" Style Locknut Socket

H3405

- 1985 to late Ford® F250-350 truck rear axle with Hi-Shear rotating nut and Ford® Dana® 80 truck rear axels



## 3 Step Spindle Remover Tool

H3604

- Pulls out 4WD spindles for lubricating the inner needle bearing and front wheel alignment
- Fits common 1/2 and 3/4 ton 4WD pickup spindles
- 3 step design fits 1-1/2", 1-5/8" and 2" spindles
- Use with 1/2" - 20 or 5/8 thread slide hammer







## FOUR WHEEL DRIVE SPINDLE LOCKNUT TOOLS

### 4 Pin 2-3/8" Outer Style Locknut Socket

H3107

- 1986 to current Ford®, Bronco® and Ranger® with Dana® axles
- 1960 to current 1/2 ton Chevrolet® and GMC®
- 1966 to current Bronco®, Blazer® and Scout®
- 1959 to current Ford® F100-F250 series
- 1969 to current Dodge® 1/2 ton vehicles

### 4 Pin Toyota® Style Locknut Socket

H3601

- Toyota® 1995 and newer Tacoma, 1996 and newer T100 and 4-Runner

### 4 Pin 1-1/2" Inner Style Locknut Socket

H3407

- Used on 1/2 and 1 ton 4WD vehicles

## FRONT END SERVICE TOOLS

### 5 PC Front End Service Kit

H3540

- Complete front end service tool kit for easy removal of most pitman arms, tie rods and ball joints
- Includes a press type separator for ball joint removal without damage to boots and other parts
- An absolute must for all front end service shops
- Comes in convenient blow mould storage case

#### Kit includes:

- **H1926** Pitman Arm/Tie Rod End Puller
- **H3609** Pitman Arm Puller
- **H3612** Tie Rod/Inner Bearing Race Puller
- **H3614** Ball Joint Separator
- **H3616** Ball Joint/Tie Rod End Remover

**5 PC Pickle Fork Kit****H3448**

- A multi-purpose kit that features all the tools required to separate most ball joints, tie rods, pitman arms and shock absorber links
- 3 heavy duty forks are made from drop forged, heat treated steel
- 2 drive handles are made from alloy steel - one handle for use with regular hammers, the other features a .401 shank for use with most popular air hammers
- Forks can be used with either drive handle
- Pilot head designed handles absorb shock and protect threads from distortion

**Kit includes:**

- Tie Rod Separator Opening **11/16"**
- Ball Joint Separator Opening **15/16"**
- Pitman Arm Separator Opening **1-1/8"**
- Alloy Handle - for use with regular hammers length 8"

**Pitman Arm Puller – Heavy Duty****H3609**

- Specially designed jaws fit the job and ensures firm grip
- Extra wide opening of **1-3/8"**
- Pull **3-1/2"**

**Pitman Arm/Tie Rod End Puller****H1926**

- For use on small cars having smaller pitman arms and tie rod ends
- Can also be used for rack and pinion steering removal
- Opening: **1-1/16"**
- Pull: **1-3/4"**

**Ball Joint/Tie Rod Remover****H3612**

- Swivel centering pin ensures a strong, positive pull
- Tool directly attaches to stud for easy and convenient use
- Fits most front wheel drive vehicles and light trucks
- Opening: **3/4"**
- Pull: **1-1/2"**

**Ball Joint Separator - Universal Application****H3614**

- Heavy duty "scissor" design suits most cars and light trucks
- Easily separates press fit ball joints
- 2-stage height adjustment feature uses a heat treated steel pin thrust bolt and steel ball insert, allowing quick and easy height adjustment changes
- The combination of the "scissor" design and the 2-stage height adjustment offers maximum versatility
- Can be used on most press fit ball joint applications





## FRONT END SERVICE TOOLS

### Dual Socket Inner Tie Rod Tool

H3060

- Features a double ended "stepped" socket
- **1-3/16" hex** fits primarily Ford® (FWD) and Renault®
- **1-5/16" hex** fits primarily GM®, AMC®, Chrysler® and Ford® (RWD)
- 1/2" Square Drive

### 4 PC Inner Tie Rod Removal Kit

H3061

- The tool kit contains everything necessary to directly remove and install the inner tie rod without the hassles of removing the steering gear
- Works on most inner tie rod structures
- Made of heavy duty alloy steel, black oxide finish
- Comes in convenient blow mould storage case

### Dual Inner Tie Rod Adapter For H3060/H3061 (1-7/16")

H3071

- **1-7/16" adapter** for GM® and Chrysler® cars with Saginaw® steering gear
- Use with H3060 Dual Inner Tie Rod Tool

H3071A

**1-3/16"** Adapter for H3060 and H3061

H3071B

**1-5/16"** Adapter for H3060 and H3061

### Ball Joint Separator (15/16" Opening)

H1902

- Removes ball joints from connecting links
- Just a few sharp blows with a hammer and the tapered prongs easily separate the parts
- Opening: **15/16"**
- Length: **12"**

### Tie Rod End Separator (21/32" Opening)

H1907

- Removes tie rod ends from connecting links
- Just a few sharp blow with a hammer and the tapered prongs easily separate the parts
- Opening: **21/32"**
- Overall Length: **16"**

### Outer Tie Rod Remover

H3616

- The adjustable jaw can spread to match tie rods of various sizes
- Removes the outer tie rod from the steering knuckle
- The custom designed jaw tips ensure maximum grip and withstands up to 5 tons of pulling force!
- The use of this mechanical screw puller ensures an evenly distributed pulling force, eliminating damage to existing parts
- Ideal for use on import and domestic cars with front and rear wheel drives with stamped or cast steel steering knuckles
- Opening: **0 to about 7"**
- Pull: **4"**

**Ball Joint Master Service Kit**

H3536

- This master kit covers most press-fit vehicle joint components
- Used to service the removal/installation of ball joints, universal joints, truck brake anchor pins and 4WD ball joints
- C-frame alone can be used to remove/replace universal joints
- Tool can remove rusted and corroded parts
- Comes in convenient blow mould storage case

**Kit includes:**

- Heavy duty C-frame and forcing screw (1.106" x 7 threads per inch)
- Receiver tubes and receiving/installation adapters to work on press fit upper and lower ball joints on most Dodge® Ram, Ford®, GM®, IHC® and Jeep® 2 and 4 wheel drive pick-up trucks, SUV's and vans (autos with Dana® front axles)

**MacPherson® Strut Coil Spring Compressor Kit**

H1560

- Allows you to quickly compress the coil spring to replace shock absorbers, spring sets, repair bent strut or strut tube and repair damaged spindle
- Designed to be used on virtually all modern domestic and imported vehicles that use MacPherson® struts
- Do not use on GM® "A", "J", or "X" body cars or coil springs that exceed a 6" outside diameter

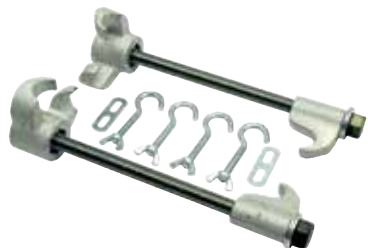
**C.V. Boot Clamp Pliers - Earless**

H1084

- For earless type clamps
- Ratchet will lock for easy use

**Ball Joint 4-in-1 Service Kit**

H3537

- For press-fit vehicle joint components
- Heavy duty, four function kit to service the removal/installation of ball joints, universal joints, truck brake anchor pins and 4WD ball joints
- Both ball joint and 4WD ball joint service can be done without taking the control arm off
- U-joint service can be performed on needle type U-joint bearings
- Truck anchor pin service can be performed with pins up to 1-1/4" diameter
- Services 4WD ball joint equipped vehicles including those vehicles with Dana® 44 front axles such as 1967 to current 1/2 ton and 3/4 ton Dodge®, GM®, Ford®, IHC®, Jeep®
- Tool will even remove rusted and corroded parts
- C-frame alone can be used to remove/replace universal joints
- Comes in convenient blow mould storage case

**Kit Includes:**

- Heavy Duty C-frame and forcing screw (1.106" x 7 threads per inch)
- Installation and removal adapters
- Installation cup adapter
- Receiving and installation cups
- 3 Receiver tubes: 2-3/4" x 2-1/4", 2-1/4" x 1-3/4", 1-3/4" x 1-3/4"

**MacPherson® Strut Deluxe Coil Spring Compressor Kit**

H3315

- Built-in detent pins to help lock the coil in place eliminating the need for extra safety hooks. Set up is faster and easier
- Comes in convenient blow mould storage case

**C.V. Boot Clamp Pliers - Eared**

H1088

- For eared type clamps
- Unique design allows user to clamp ring and then use a torque wrench in 1/2" square drive holes in handle to accurately set clamp
- Plunger can be deactivated





#### 1/4" Drive Flexible Radiator Hose Clamp Driver

H3319

- Multi-use, flexible-shaft, 1/4" drive socket driver
- 12" Overall length shaft will tighten or loosen hex head screws on gear type hose clamps and other applications in even the most hard to get at places
- 1/4" drive end allows operator to attach any 1/4" drive socket to fit the job



#### Hose Clamp Pliers - Flexible Flat Band Type

H3290

- Designed to access the flat-type hose clamps located in hard-to-reach areas
- Pliers have locking mechanism to hold clamp in the open position - for easy removal and installation of clamp
- Spring loaded handles
- Heavy-duty 24" cable flexes to almost any position
- Range: **0-2-1/16" (0-53 mm)**
- Length: **33"**
- Replacement Part: **H3290-10** Cable Assembly



#### 3 PC Hose Pinch-Off Pliers Set

H3318

- For use on all brake and fuel hose lines
- Special rounded edges ensure no damage to lines or internal reinforcements
- Lightweight and non-conductive
- Three sizes for use on most jobs

#### Set includes:

- **H3140** Capacity **1/4" - 7/16" (6 - 12 mm)**
- **H3316** Capacity **1/2" - 3/4" (13 - 19 mm)**
- **H3317** Capacity **3/4" - 2-1/4" (19 - 57 mm)**



### Small Hose Pinch Off Pliers (1" Capacity)

H3128

- No need to drain system when changing thermostats. Save coolant - save time
- Heat treated jaws swivel for parallel clamping
- Steel arms automatically lock with ratchet
- May also be used to pinch off vacuum lines
- Overall Length: **10"**
- Capacity: **Up to 1"**
- Note: Not for use on wire reinforced radiator hose



### Small Hose Pinch Off Pliers (1-3/8" Capacity)

H3129

- No need to drain system when changing thermostats. Save coolant - save time
- Heat treated jaws swivel for parallel clamping
- Steel arms automatically lock with ratchet
- May also be used to pinch off vacuum lines
- Overall Length: **12"**
- Capacity: **Up to 1-3/8"**
- Squeezes wire reinforced radiator hose



# DRIVE BELT TOOLS

### 14 PC Deluxe Serpentine Belt Tool Kit

H3529

- Enables rapid and easy removal and installation of belts on serpentine belt equipped vehicles
- Connect the tool to the spring loaded idler pulley to release the tension
- Fits most vehicles

#### Kit includes:

- Serpentine belt tool with cushion grip
- Extension Bars: **6"** and **10"** - for versatility and leverage
- Sockets: **13, 14, 15, 16, 18 mm** - with custom 16 mm drive end to fit bars
- 3/8" and 1/2" Drive adapters - with custom 16 mm drive end to fit bar
- 3/8" Drive Crowfoot Wrenches **13, 14, 15 mm** - use with 3/8" adapter above
- 3/8" - 16 UNC Bolt - to attach extension bars to long handle
- Comes in convenient blow mould storage case





## FAN CLUTCH WRENCHES

### 10 PC Fan Clutch / Water Pump Wrench Kit

H3530

- Removes and installs fan clutches and water pumps on most Chrysler®, Ford® and GM® vehicles
- Holding wrench immobilizes the fan clutch. The nut wrench turns the nut on or off
- Works in tight spaces where conventional wrenches won't reach
- Heat-treated for strength and durability
- Use with 1/2" drive ratchet or breaker bar for more torque

#### Kit includes:

- Fan Pulley Holding Tool: **2-1/4"** and **3-1/4"**
- Fan Clutch Bolt Holding Tool: **2-3/8"**
- Fan Clutch Pulley Holding Tool: **2-1/8"** and **3"**
- Fan Clutch Nut Wrench: **1-7/16"**
- Fan Clutch Wrench: **1-7/16"** and **1-9/16"**
- Fan Hub Wrench: **2-13/16"**
- Clutch Nut Wrench (left hand): **1-7/8"**
- Comes in convenient blow mould storage case



### 4 PC Fan Clutch Wrench Kit

H3531

- Designed for removing and installing fan clutch assemblies on most Ford® engines
- Holding wrench immobilizes the fan clutch. The nut wrench turns the nut on or off
- Works in tight spaces where conventional wrenches won't reach
- Heat treated for strength and durability
- Use with 1/2" drive ratchet or breaker bar for more torque
- The small double-ended wrnech is for 2.8, 2.9, 3.0, 4.0 and 4.9 litre engines
- The large single-ended wrenches and large holding wrnech are for 6.9 and 7.3 litre diesel engines

#### Kit includes:

- Double-ended Fan Clutch Wrench: **36mm and 1-9/16"**
- Fan Clutch Holding Wrench: **58mm**
- Fan Clutch Holding Wrench: **1-7/8"**
- Fan Clutch Holding Wrench: **3-1/4"**
- Comes in convenient blow mould storage case

## Compression Tester Gas Engines

H1730

- Quick disconnect flexible hose
- This quality, accurate tester has an angle construction tip to permit easy reading on back cylinders
- The most popular type in use today
- The heavy duty neoprene hose bends in all directions for hard-to-reach cylinders



H1730

## Compression Tester Gas Engines

H1731

- Same features as H1730 without quick disconnect flexible hose
- Handy side release valve allows multiple readings on the same cylinder without removing the tester from the cylinder
- Hose assembly will disconnect easily from the gauge head to allow more flexibility and easier installation into spark plug holes



H1731

## Accessories - Replacement Parts

H1730B	Quick Coupler - H1730
H1730C	Hose Assembly Fits - H1730/H1731
H1730D	Long 14 mm Adapter - H1730/H1731
H1730E	10 mm Adapter - H1730/H1731
H1730F	12 mm Adapter - H1730/H1731
H1730H	16 mm Adapter - H1730/H1731

## Cylinder Leak Down Tester

H3042

- Tests for worn or broken rings, defective intake and exhaust valves, scored or cracked cylinders, leaky head gaskets and worn or stripped spark plug threads by measuring the amount of compressed air held in an engine cylinder
- Easy to use on all 2 and 4 cycle gasoline and diesel engines
- Dual gauges allow you to monitor input air line pressure up to 100 PSI
- Unit has precision pressure regulator to adjust pressure in cylinder to "set" area on regulator gauge
- Regulator gauge will read percentage of leak down in cylinder while the input pressure gauge assures that input pressure is steady



H3042

## Replacement Parts

H3042A	Gauge Head - H3042
H3042B	Regulator - H3042
H3042C	Leakage Gauge - H3042
H3042D	11-1/4" Hose Assembly with 14 and 18mm Adapters
H3042K	Diesel Hose Adapter for H3042

## Accessories

H1730E	10 mm Adapter - H1730/H1731
H1730F	12 mm Adapter - H1730/H1731
H1730H	16 mm Adapter - H1730/H1731

**Compression Tester for Diesel Engines**

H1845

- For most diesel trucks and cars
- Supplied with three popular adapter numbers **H1845D, H1845E and H1845J**
- Easy-to-read 2-1/2" diameter gauge head
- Flex hose with swivel head eliminates the need to remove auxiliary equipment such as power brakes and steering, air conditioning and manifold
- Quick side release valve to reset gauge without removal of adapter
- Gauge Range: 0 - 1,000 PSI, 0 - 70 kg/cm<sup>2</sup>

**Adapters Available:**

- Listed by vehicle make
- See illustrations

**Replacement Parts:**

- **H1845A** Hose Assembly 24-1/4"
- **H1845B** Gauge Head
- **H1845C** Quick Coupler
- **H1845G** Valve Core



**Accessories - Adapters - Replacement Parts - H1845 Diesel Tester**

Manufacturer	Engine	Type	Thread (in)	Adapter
Allis Chalmers	6000, 7000, 10,000, 11,000	Injector		H1845P
Allix		Injector		H1845P
Audi	All	Injector	24 x 2.0	H1845E*
Audi	1.5, 1.6, 2.0, 2.6 LITRE	Glow Plug	12 x 1.25	H1845H
BedFord™	200, 220, 300, 330, 466	Injector		H1845P
BMW	2.4L	Glow Plug	12 x 1.25	H1845H
Case		Injector		H1845P
Caterpillar	3208, 110 Pencil Type	Injector		H1845FF
Caterpillar	D336, 1674, 1676,	Injector	7/8 x 14	H1845GG
Caterpillar	3406, 3408, 3412	Injector	7/8 x 14	H1845GG
Continental	W/Volvo Engines	Glow Plug	10 x 1.25	H1845M
Cummins	V-185, V-210, V225	Injector		H1845Q
Cummins	V-555, VT-255, VT-555	Injector		H1845Q
Cummins	H, HR, NH, NVH, V6, V8,	Injector		H1845Q
Cummins	V12, All 5.5 Bore	Injector		H1845Q
Cummins	NH and 903 V8 Cylindrical PTB	Injector		H1845Q
Cummins / Case "B"	2.9L, 3.9L, 5.9L	Injector	24 x 1.5	H1845Y
Cummins / Case "C"	8.3L	Injector		H1845DD
Datsun		Injector	24 x 2.0	H1845N
Detroit Diesel	53, 71, 92, 110, 149, V53, V71	Injector		H1845R
Dodge / Cummins	5.9L	Injector	24 x 1.5	H1845Y
Dodge / Cummins	Late model 5.9L ISB & QSB 24 valve	Injector		H1845-3
Flat Allis	8035-02-300, 8035-02-301	Injector		H1845P
Flat Allis	8035-02-302, 8045-02, 8045-03	Injector		H1845P
Ford™	2.0L	Glow Plug	10 x 1.25	H1845M
Ford™ / Escort		Glow Plug	10 x 1.25	H1845M
Ford™ / Lynx		Glow Plug	10 x 1.25	H1845M
Ford™ / Mazda	2.0L	Glow Plug	10 x 1.25	H1845M
Ford™ / Navistar	6.9, 7.3L	Glow Plug	10 x 1.0	H1845D*
Ford™ / Navistar	7.3L Turbo Diesel	Glow Plug	10 x 1.0	H1845KK
Ford™ / Navistar	7.3L Turbo Diesel	Glow Plug	10 x 1.0	H1845-2
Ford™ / Powerstroke	6.0L, 6.4L	Glow Plug	14 x 1.25	H1845-4
Ford™ Ranger	2.2L	Glow Plug	10 x 1.25	H1845M
Ford™ Tempo		Glow Plug	10 x 1.25	H1845M
Ford™ Topaz		Glow Plug	10 x 1.25	H1845M
Ford™ Toyo Kogyo	2.2L	Glow Plug	10 x 1.25	H1845L
Ford™ Tractors	21mm Bosch	Injector		H1845P
Ford™/ Mazda	2.0L	Glow Plug	10 x 1.25	H1845L
General Motors	4.3L V6 & V8, 5.7L V8	Glow Plug	10 x 1.0	H1845D*
General Motors	6.2L & 6.5L V8 True Diesel	Glow Plug	10 x 1.0	H1845J*
GMC® Truck	W4, W7, W7HV	Glow Plug	12 x 1.25	H1845H
GMC® Truck	6.6L	Glow Plug	10 x 1.25	H1845K
Hino	Medium	Glow Plug	12 x 1.25	H1845H
Int'l Harvester	6.9 L	Glow Plug	10 x 1.0	H1845D*
Int'l Harvester	D/DT361, D/DT429, DV462	Injector		H1845P
Int'l Harvester	DV/DVT550, DT/DV/DVT573	Injector		H1845P
Int'l Harvester	361, 407	Injector		H1845P
Isuzu Chevette	1.8L	Glow Plug	10 x 1.25	H1845K
Isuzu GM	1.8L, 2.2L	Glow Plug	10 x 1.25	H1845K
Isuzu/Luv	2.2L	Glow Plug	10 x 1.25	H1845K
Isuzu Truck	NPR, KS	Glow Plug	12 x 1.25	H1845H
J.I. Case	All Models Except Pencil Type	Injector		H1845P
J.I. Case	188, 207, CID, Pencil Nozzle	Injector		H1845FF



H1845D



H1845F



H1845J



H1845N



H1845V



H1845DD



H1845FF



H1845K



H1845P



H1845W



H1845E



H1845GG



H1845KK



H1845Q

Manufacturer	Engine	Type	Thread (in)	Adapter
John Deere	Early 300, 400, 500 276	Injector		H1845FF
John Deere	Early 404, 532 CID	Injector		H1845FF
John Deere	404, 466, 531, 619	Injector		H1845P
Kubota	Some models	Glow Plug	10 x 1.25	H1845M
Kubota	Some models	Glow Plug	8 x 1.0	H1845-5
Land Rover		Glow Plug	14 x 1.25	H1845V
Lealand British		Glow Plug	14 x 1.25	H1845V
Lincoln, Mark VII	2.4L 1984 & 1985 cars	Glow Plug	12 x 1.25	H1845H
Mack Truck		Injector		H1845P
Mack Truck	END 405, 457, 475, 510, 519	Injector		H1845P
Mack Truck	605, 672, 673, 674, 711, 864	Injector		H1845P
Mack Truck	END T673, 675, 676, 865, 866	Injector		H1845P
Massey Ferguson		Injector		H1845P
Massey Ferguson	4.203, 4.236, 4.248, 6.354, 8.540	Injector		H1845P
Mercedes	All with 24mm	Injector	24 x 2.0	H1845E*
Mercedes	All with 12mm	Glow Plug	12 x 1.25	H1845H
Mercedes	All with 18mm	Glow Plug	18 x 1.5	H1845F
Mercedes	All with 22mm	Injector	22 x 1.5	H1845HH
Mitsubishi	2 & 3 cylinder engines	Glow Plug	10 x 1.25	H1845M
Mitsubishi-Fuso	Medium	Glow Plug	10 x 1.25	H1845M
Mitsubishi-Fuso	Medium	Injector		H1845P
Navistar	DT360, DT466, 9.0L	Injector		H1845EE
Navistar	312, 360, 414, 436, and 466 C.I.D.	Injector		H1845EE
Navistar	6.9L, 7.3L	Glow Plug	10 x 1.0	H1845D*
Nissan	2.2L	Glow Plug	10 x 1.25	H1845M
Onan	DSL, MDSL	Injector		H1845P
Opel		Injector	22 x 1.5	H1845X
Peugeot	All 2.0 & 2.3L	Glow Plug	12 x 1.25	H1845H
Peugeot		Glow Plug	18 x 1.5	H1845F
Renault		Injector	24 x 2.0	H1845W
Renault		Injector	22 x 1.5	H1845X
Scania	DN11 & DS11	Injector		H1845P
Toyo Kogyo	2.2L	Glow Plug	10 x 1.25	H1845M
Toyota	1.8L	Glow Plug	10 x 1.25	H1845K
Toyota	2.2L	Glow Plug	10 x 1.25	H1845M
UD-Nissan Truck	Medium	Glow Plug	10 x 1.25	H1845M
Volvo	All	Injector	24 x 2.0	H1845E*
Volvo		Glow Plug	12 x 1.25	H1845H
VW	All	Injector	24 x 2.0	H1845E
VW		Glow Plug	10 x 1.0	H1845Z
VW		Glow Plug	12 x 1.25	H1845H
Waukesha	All	Injector		H1845P
White Farm	66, 77, 88, 99, 166, 177, 188, 199	Injector		H1845P
White Farm	550, 660, 770, 880, 950, 1550	Injector		H1845P
White Farm	1555, 1600, 1650, 1655, 1750	Injector		H1845P
White Farm	1755, 1800, D2000, 2300, 3000	Injector		H1845P
Wisconsin	340, 350, 430, 660, 670, 750	Injector		H1845P
Wisconsin	860, 1000	Injector		H1845P



H1845X



H1845EE



H1845H



H1845L



H1845R



H1845Y



H1845ET



H1845HH



H1845M



H1845S



H1845Z



H1845-2



H1845-3



H1845-4

For applications not listed above: H1845S - 1/8" N.P.T. Male Quick Coupler.

This adapter along with 1- H1845G Valve Core (thread size 12-36) can be used to make your required adapter for engines not listed above. Remove internal mechanism from an old injector or glow plug from that engine, drill and tap to accept the quick coupler and valve core.

\*Included in Kit





## COMPRESSION AND PRESSURE TESTERS

### Vacuum and Pressure Tester

H1728

- 2-1/2" Chrome plated vacuum tester aids diagnosis of engine problems such as sticky valves, timing, carburetion, faulty fuel pump, and other vacuum-operated devices
- Brass adapter fitting provided
- Pressure Range: **0 - 15 PSI, 0 - 1 kg/cm**
- Vacuum Range: **0 - 30 in, 0 - 76 cm HG**

#### Replacement Parts:

- **H1728A** Gauge Head

**CAUTION:** Do not use on fuel injected vehicles

### Oil Pressure Tester

H3041

- Check oil pressure in automatic transmissions and engines
- Adapters used on most domestic and imported cars and light trucks including late models
- Supplied with two gauges:
  - High Pressure Gauge - Calibrated from **0 - 300 PSI, (0 - 21.0 kg/cm<sup>2</sup>)**
  - Low Pressure Gauge - Calibrated from **0 - 100 PSI, (0 - 7.0 kg/cm<sup>2</sup>)**
- Use high pressure gauge for all applications
- Use low pressure gauge for more accurate reading of engine oil pressure where maximum oil pressure does not exceed 100 PSI (7.0 kg/sq.cm)
- Comes in a durable vinyl pouch
- Full instructions provided
- **Note:** Do not use low pressure gauge to test automatic transmission pressure

#### Replacement Parts:

- **H1734X** gauge head (H1730, H1731, H3041)
- **H3041B** gauge head 100 PSI
- **H3041C** hose assembly (6' oil proof hose)
- **H3041D** 11 piece adapter kit
  - 1 ea. Bushing, 3/8" NPT Male
  - 1 ea. Bushing, 1/4" NPT Male
  - 2 ea. 90 degree elbow 1/8" M to F
  - 1 ea. 1/8" M to 1/4" M adapter
  - 1 ea. 1/8" F to 1/8" F Coupling
  - 1 ea. 2" extension, 1/8" M to 1/8" M
  - 1 ea. 10 mm adapter
  - 1 ea. 1/8" BSP adapter
  - 2 ea. 8mm adapter

**Piston Ring Compressor Kit - Ring-O-Matic Series** H1670

- Quick change design speeds piston ring installation and increases production
- The Ring-O-Matic pliers and bands are designed to operate in all positions, not just vertically or horizontally
- Pliers incorporates precision locking action for exact holding and quick release

**Kit Includes:**

- **H1670A** Ring-O-Matic Pliers
- **H1670B** for Pistons **2-7/8" - 3-1/8"**
- **H1670C** for Pistons **3-1/8" - 3-3/8"**
- **H1670D** for Pistons **3-3/8" - 3-5/8"**
- **H1670E** for Pistons **3-5/8" - 3-7/8"**
- **H1670F** for Pistons **3-7/8" - 4-1/8"**
- **H1670G** for Pistons **4-1/8" - 4-3/8"**

**Larger bands available:**

- **H1670H** for Pistons **4-1/2" - 4-3/4"**
- **H1670I** for Pistons **4-3/4" - 5"**
- **H1670J** for Pistons **5" - 5-1/4"**
- **H1670K** for Pistons **5-1/4" - 5-1/2"**
- **H1670L** for Pistons **5-1/2" - 5-3/4"**
- **H1670M** for Pistons **5-3/4" - 6"**



## HEAD AND VALVE REPAIR TOOLS

**Deluxe Overhead Valve Spring Compressor** H3456

- Designed to service most cars with overhead valves and newer vehicles with confined areas under the hood
- The knob is removable exposing a 5/8" hex post allowing the technician to operate the tool with a 5/8" wrench or socket
- The components are heat treated for added strength and long service life
- Not to be used with impact tools
- Use on or off the car



**Valve Spring Compressor** H3183

- Vertical lift design
- Equipped for 1" - 2" spring diameters. Height: 10" Width: 8"
- Prevents bending of valve stem. Sure, one hand control lock and release is powerful enough to compress the strongest spring with ease
- Quickly adjusts for any valve stem length. One simple adjustment with the pin-operated screw on the first set of valves sets clamp for the balance of springs.
- Replacement Jaws (included with tool): H3183A Straight Jaw (pair), H3183B Offset Jaw (pair)
- Optional Jaws: H3183C Extra High Offset Jaw





H1183



H1185



## VALVE LAPPING TOOLS

### Rubber Cup Valve Lapping Sticks

- For precision hand grinding valves and seats
- Synthetic rubber cup is resistant to oil, gasoline and grinding compounds
- Comfortable wooden handle. A must for that final valve seat fitting operation

#### PROD. NO.

#### Cup

H1183

3/4"

H1185

1-3/16" and 1-5/16"

## TUNE-UP TOOLS

### Ignition Point and Machine File

H1866

- Double cut ignition files made from high quality steel with Rockwell Hardness of 65
- Easily cuts tungsten or platinum contact points
- Use on ignition points, spark plugs, relays, circuit breakers and much more
- 2 per package

### In-Line Ignition Spark Tester

H3143

- Connects in-line between spark plug and spark plug wire
- Shows a duplicate view of the ignition spark
- Technician can visually check condition of each cylinder
- Frequency and intensity of flash pattern indicates whether there is an ignition or fuel delivery system problem. Flash can be seen in bright sunlight
- Clear plastic body can withstand rough use and resists automotive chemicals
- Flexible wire protected by mechanical strain relief
- Instructions included

### Spark Plug Boot Pliers - Angled Jaws

H3295

- Designed to protect against plug wire and boot separation.
- Handle and jaws are vinyl coated to insure complete insulation and non slip grip
- Overall length: **9-3/4"**

### Mechanic's Stethoscope

H1262

- This sensitive instrument provides a fast and accurate method of locating problem in engines and other moving parts
- Earphones block outside noises
- Plastic handle protects user from shock

## Muffler Expanders

- Use with impact wrench
- Removes clamp grooves and rounds out exhaust pipes
- A practical, rugged tool that makes easy work for a tough job
- Expansion rings set in deep grooves to prevent wear

**CAUTION:** Not to be used to stretch pipes

### Pipe & Muffler Expander - Standard

H1017

- For Passenger Cars

### Pipe & Muffler Expander - Small

H1175

- For Compacts & Foreign Cars

### Pipe & Muffler Expander - Extra Large

H1176

- For Passenger Cars & Trucks

Exhaust System



H1017 / H1175



H1176

## PRESSURE TESTERS

- Unique design allows pressure to be taken either through the oxygen sensor hole or through the exhaust pipe with a threaded insert system (included)
- Accurately determines excessive exhaust back pressure caused by catalytic converter or muffler blockage

### Exhaust Pressure Tester

H3148

#### Kit Includes:

- **H3148A** Gauge: 0 - 15 lb
- **H3148B** Hose Assembly
- **H3148C** Insert Installing Tool
- **H3148D** Oxygen Sensor Adapter 18mm
- **H3148E** Oxygen Sensor Adapter 12mm
- **H3148F** 10 Pack: Inserts, Washers, Screws



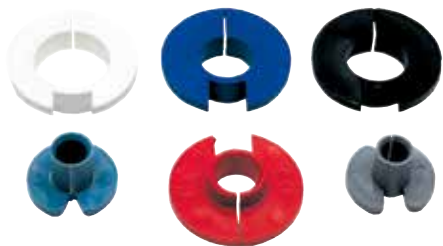

## FLUID LINE TOOLS

### 6 PC Disconnect Tool Set

H3501

- Easily disconnect spring lock couplings on Ford® and Chrysler® air conditioning lines
- Use on fuel line quick connect couplings found on late model GM®, Ford®, and Chrysler®
- Can be used on Ford® transmission and radiator cooler lines
- Set contains six colour coded tools that are stamped with size for quick identification
- Sizes: SAE **5/16", 3/8", 1/2", 5/8", 3/4", 7/8"**  
Metric **8, 9, 13, 16, 19, 22 mm**

### 11 PC Master Disconnect Tool Set

H3544

- This master fuel line quick disconnect tool set broadens the applications of disconnecting fittings and spring lock couplings on fuel, filter cooler and transmission oil lines
- Fuel line disconnects are colour coded anodized aluminum for easy identification
- A must for all mechanical service shops
- Use with most vehicles on the market today
- Comes in convenient blow mould storage case

### Disconnect Tool Set for Fuel and Air Conditioning Lines

H3089

- This spring-lock coupling release tool easily separates fittings on fuel and air conditioning lines
- Sizes: **3/8", 1/2", 5/8"** and **3/4"**

### Disconnect Tool for Fuel Lines

H3351

- This spring-lock coupling release tool easily separates fittings on fuel lines
- Sizes: **3/8"** and **5/16"**

### Disconnect Tool for GM® Heater Lines

H3364

- Releases heater line quick connect fitting from engine block and thermostat housing
- 1991 - current GM® 3.1L / 3.4L and 3800 engines



**Disconnect Tool for Ford® Fuel Lines**

H3352

- 1990 - current Ford® Ranger® and Explorer with 4.0 Litre, 6 cylinder engines



**Disconnect Tool for Ford® / GM® CFI Fuel Lines**

H3353

- Ford® CFI fuel lines with hair pin connectors
- Universal for radiator to transmission oil cooler lines
- 1987 and later model Olds Toronado; Buick Riviera® and Reatta®; Cadillac Eldorado®, Seville® and Concours®; 1989 and later Model GM® 1/2, 3/4 and 1 Ton pickups



**2 PC Disconnect Tool Kit for Fuel, Transmission and Oil Cooler Lines**

H3354

- Separates quick connect fittings from transmission, radiator oil cooler and power steering lines

**Kit Includes:**

- Ford®/GM® quick disconnect coupler tool and Ford® oil cooler line disconnect tool

**Applications:**

- Ford® EFI fuel lines with hair pin connectors
- Transmission/oil cooler lines on 1989 - current/GM® 1/2, 3/4 and 1 Ton pickups; 1986 - current Ford® Taurus and Mercury Sable with AXOD, AOD, or ATX transmissions



**Disconnect Tool for Ford® Oil Cooler Lines**

H3355

- Ford® vehicles with AXOD, AOD, or ATX transmission



**1/4" Disconnect Tool for Fuel Lines**

H3356

- 1995 - 1996 Ford® Mustang 1/4" fuel pump return line



**5/16" Disconnect Tool for Fuel Lines**

H3357

- 1990 - current Ford® Aerostar, Explorer, Bronco® with 5/16" fuel lines
- 1991 - current Ford® E and F series trucks with 5/16" fuel lines
- 1992 - current Ford® Ranger® with 5/16" fuel lines
- 1992 - current GM® with 5/16" fuel lines



**3/8" Disconnect Tool for Fuel Lines**

H3358

- 1990 - current Ford® Aerostar, Explorer, Bronco® with 3/8" fuel lines
- 1991 - current Ford® E and F series trucks with 3/8" fuel lines
- 1992 - current Ford® Ranger® with 3/8" fuel lines
- 1994 - 1997 Dodge® Ram V6 and V8 trucks with 3/8" cooler lines
- 1995 - 1996 Dodge® Ram Van/Wagon with 3/8" cooler lines



**Disconnect Tool for Ford® Oil Cooler Lines**

H3359

- Ford Taurus® and Escort® oil cooler lines on AXOD or ATX transmission



Caution: release system pressure before using these tools!

**40 PC Master Fuel Injection Test Kit****H2000**

- Contains all items necessary for checking the fuel injection systems on most domestic and foreign vehicles
- Features a large, **3-1/2" gauge** head with dual readings of **0 - 145 PSI** and **0 - 1,000 kPa**, and **2-1/2" gauge** with dual readings of **0 - 15 PSI** and **0 - 100 kPa**
- All adapters, gauge heads, and hose assemblies feature a quick coupling system
- Comes complete with instructions in a blow moulded carrying case
- Case will accommodate H2000UPA Supplement Kit

**Parts and Accessories for Test Kits H2000/H2002****Gauges and Hoses**

H2000A	3-1/2" Gauge Head with dual readings 0-145 PSI and 0-1000 KPA (10 Bar) Can be used for all tests
H2000AA	Low pressure 2-1/2" Gauge with dual readings 0-15 PSI and 0-1kg/cm <sup>2</sup> (1 Bar) Use for tests where an accurate reading below 15 PSI is required
H2000AB	Quick Coupler
H2000D	Gauge Hose Assembly with blow-down valve
H2000G	CIS/TBI Test Hose
H2000DX	72" Extension Hose
H2000RK	Repair Kit, O-Rings, Washers

**Test Port Adapters**

H2000B	Large Schrader Type Test Hose with 7/16" x 20 thread
H2000BK	Replacement Washer and Pin for H2000B
H2000B90	Large Schrader 90° Adapter
H2000C	Small Schrader Type Test Hose with .308 x 32 thread
H2000C90	Small Schrader 90° Adapter

**In-Line Testing TBI**

H2000S	Union 5/8" x 18
H2000T	16 mm x 1.5 Female Tube Nut (2)
H2000U	16 mm x 1.5 Male Tube Nut (2)
H2000UA	14 mm x 1.5 Female Tube Nut (2)
H2000UB	14 mm x 1.5 Male Tube Nut (2)
H2000UC	14 mm x 1.5 Plug
H2000UPA	
H2000V	5/8" x 18" Male Fitting (2)

**In-Line Testing - Special Connections**

H2000F	Double-ended Hose Fitting 5/16" - 3/8"
H2000W	Spring Lock Hose - Common Application Ford® CFI
H2000X	Hair Pin Hose 5/16" - Common Application Ford® EFI
H2000XA	Hair Pin Hose 3/8" - Common Application GM®, Chrysler®

**Multi-Port Injection Pressure Tester****H2002**

- Test fuel pump pressure on most domestic and import vehicles equipped with multi-port fuel injection systems using the small or large Schrader type connection
- Can be used on most import vehicles, except those equipped with Bosch C.I.S
- Includes bleed-off valve with hose to safely enable technician to depressurize fuel system after testing
- **3-1/2" gauge** diameter has dual scale: **145 PSI/1,000 kPa**
- Full instructions included
- Supplied in vinyl storage pouch

**End of Line, Banjo - Fuel Bolt Adapters**

H2000E	Single End Hose Connection - 1/4" x 3/8"
H2000N	6 mm x 1.0 Thread
H2000NN	8 mm x 1.0 Thread
H2000P	10 mm x 1.0 Thread
H2000Q	12 mm x 1.25 Thread
H2000R	12 mm x 1.5 Thread
H2000RA	14 mm x 1.5 Thread

**In-Line Testing CIS, CISE and K-Jetronic**

H2000H	8 mm x 1.0 Male Long
H2000HA	8 mm x 1.0 Female Long
H2000HH	10 mm x 1.0 Male
H2000J	8 mm x 1.0 Female
H2000K	12 mm x 1.5 Swivel Female (2)
H2000KA	14 mm x 1.5 Swivel M and F
H2000KB	16 mm x 1.5 Swivel M and F
H2000KC	1/4 BSPT Swivel M and F
H2000L	10 mm x 1.0 Female
H2000M	8mm x 1.0 Male (2)

**Adapters for Chrysler® and Mitsubishi®**

H2000M11	11 mm
H2000M15	15 mm
H2000M16	16 mm



## 7/8" with Cut-Away Oxygen / Vacuum Sensor Socket

H3327

- Removes and installs oxygen sensors and vacuum switches on computerized engine control vehicles
- 3/8" drive x 7/8" hex socket with cut-away slot provides extra clearance for oxygen sensor wires during use



## 1-1/16" Oil Pressure Sending Unit Socket

H3440

- Remove and install 1-1/16" oil pressure sending units up to 2-5/8" long
- Heat treated alloy steel
- Use with 3/8" square drive or 1-1/8" hex wrench
- Fits most 1991 to current GM® vehicles using oil pressure gauge and 1987 to current Chrysler® with light and gauge



## 7/8" 6 Point Oxygen Sensor Offset Socket Wrench

H3586

- Removes and installs oxygen sensors on vehicles with computerized engine control
- Offset design for increased maneuverability
- 7/8" 6 point socket with cut-away slot provides extra clearance for oxygen sensor wires during use



## Oxygen Sensor Offset Socket Wrench

H3346

- Removes and installs oxygen sensors on vehicles with computerized engine control
- Offset design for increased maneuverability
- Features a 7/8" hex and 1/2" double square drive with cut-away slot providing extra clearance for oxygen sensor wires during use



## 29mm Narrow Slot Oxygen / Vacuum Sensor Socket

H3580

- 1/2" drive, 29mm narrow slot oxygen sensor socket



## 27mm Injector Socket

H3595

- 1/2" drive, 27mm x 3-1/4"
- With window



## 7/8" Narrow Slot Oxygen / Vacuum Sensor Socket

H3583

- 3/8" drive x 7/8"





## BLOW GUNS

### Spray Cleaning Gun Kit

H3192

- High speed 2-way action quickly blasts dirt, grease and oil
- Sprays cleaning solvents under high pressure. Will also blow air only
- Pressure trigger for maximum efficiency
- Includes 4 ft siphon hose with screen
- Operates with 1 hp or larger air compressor delivering 3.0 CFM at 60 psi
- Air inlet: 1/4" NPT

## PULLERS AND PULLER KITS

### Power Steering Pump & Alternator Pulley Tool

H3341

- 2-in-1 tool removes and installs pulleys
- Features a two sided flange which fits all domestic automobiles including GM®, Chrysler® and Ford®
- Remove and install Saginaw®, Thompson® and Ford® C-2 power steering pumps with grooved assemblies
- Works on alternator pulleys with the following grooved hub diameters:

**SAE 1-1/8, 1-1/4, 1-5/16, 1-3/8"**

**Metric 28, 32, 34, 35 mm**

**⚠ CAUTION:** Do not use with impact tool!

### 6 PC Power Steering Pump Pulley Kit

H3565

- Remove and install power steering pump pulleys without damage
- Use on most Chrysler®, Ford® and GM® vehicles
- Comes with two screw shafts for various pump sizes
- Fits pulley hub diameters of: **1-1/8, 1-1/4, 1-5/16, 1-3/8"**
- Comes in convenient blow mould storage case

#### Applications:

- 1988 - to current GM® Quad 4 engines
- 1989 - to current GM® 1/2", 3/4", and 1 ton pickups
- 1990 - to current Chevrolet Lumina® APV, Pontiac TransSport®, Oldsmobile Silhouette®
- 1991 - to current (3.1L V6 engines) Chevrolet Lumina® sedan, Olds Cutlass Supreme®, Buick Regal®, Pontiac Grand Prix®
- 1991 - to current Ford® (4.6L engines)
- The included H3353 disconnect coupler tool disconnects the fuel line on most 1987 - to current Cadillac®, Oldsmobile®, and Buick® vehicles

## Power Steering Pump Pulley Kit

H3566

- Remove and install alternator and power steering pulleys on late model Chrysler®, Ford® and GM® engines
- Reverse the jaws to pull the alternator internal bearings
- Will not damage pump or pulley
- Comes in convenient blow mould storage case

### Applications:

- 1988 - to current GM® Quad 4 engines
- 1990 - to current Chevrolet Lumina® APV, Pontiac TransSport®, Oldsmobile Silhouette®
- 1991 - to current (3.1L V6 engines) Chevrolet Lumina® sedan, Olds Cutlass Supreme®, Buick Regal®, Pontiac Grand Prix®
- 1991 - to current Ford® (4.6L engines)

### Kit Includes:

- Pulley Body, Centre Bolt, 2 Piece Jaws with Retaining Ring, Bearing, Washer and small Button
- Puller Pins for Quad 4, GM® 3.1L
- Installing Screws for Quad 4, GM® 3.1L, Ford® 4.6L and others



## 1-1/4" Gear and Bearing Puller

H1905

- Unique spring action that permits a one handed operation
- Forces the jaws tighter as more pressure is applied to the pressure screw
- Pressure screw has a protector on the end to prevent damage to the object pulled
- The 1-1/4" capacity is ideal for small bearing, battery terminals and other small pulling jobs
- All parts are plated for rust and corrosion protection



## 5 PC Internal and External Bearing Puller Kit

H3562

- Remove internal and external bearing cups, seals, bushings etc
- Special cone adapter included which securely locks jaws on part to be removed
- Use with slide hammer for more torque
- Comes in convenient blow mould storage case

### Kit Includes:

- 2.7 lb (1.24kg) Slide Hammer (5/8"-18 thread)
- Two Internal 3 Jaw Kits (Capacity 10 - 30mm, 30 - 80 mm)
- External 3 Jaw Kit (10 - 80 mm)
- Cone adapter







## PULLERS & PULLER KITS

### Steering Wheel Puller

H1903

- For all major makes of automobiles: 5/8" x 4" centre screw has recessed floating swivel
- Five Sets of (2 each) side screws: 3/8" - 16 x 4", 5/16" - 18 x 4-1/2", 5/16" - 24 x 3-1/2", 1/4" - 28 x 3", M8 x 1.25 x 80 mm

### Harmonic Balancer Puller Kit

H1901

- Designed to pull balancers, vibration dampers, pulleys, or any tool with tapped holes.
- Two or three hole applications
- Floating swivel prevents damage to shaft ends
- Range: **1-3/8" - 3-9/16"**
- 5 sets of side screws provided

### Pilot Bearing Slide Hammer Puller

H1921

- Slide hammer type
- Use to remove sleeve type bearings from 1/2" - 1-1/2" inside diameter on flywheels, pumps, and generators
- Turn the handle for quick adjustment and the centre rod spreads the alloy steel jaws for a tight fit inside the bearings
- A few light taps with the sliding hammer, and the bearing is removed

### Slide Hammer Multi-Purpose Puller Set - Heavy Duty

H3560

- Extract flange-type rear axles, semi-floating rear axles bearings, balancers and other press-on parts
- With the 2/3 jaw combination, it can remove gears, outer races, grease retainers, oil seals and other internal/ external pulling jobs
- Use on most cars and light trucks that have axles with bolts and studs no larger than 9/16" in diameter
- Applies to 4.5 and 6 bolt stud circles that range from 4-1/4" - 5-9/16"
- Slide hammer is: 5 lb (2.32kg)
- Comes in convenient blow mould storage case

**2 or 3 Jaw Combination Gear Pullers**



- Assemble with 3 jaws for maximum stability, or with 2 jaws where access is limited - 2 pullers in 1
- Jaws, yokes and forcing screw made of heat treated Chrome Vanadium steel for ultimate strength
- Reversible jaw design allows internal and external pulling
- Jaws grip tighter as pulling force increases
- All components hardened to HRC 42~45 for professional use
- Fine threaded 440 CrV forcing screw precise control for damage free pulling
- Can be used with bearing separators



PROD. NO.	MOD. NO.	Reach	Spread	Capacity	Screw Length	Pitch	Jaw Thickness	Jaw Width
770132	JGP-3HD	<b>3-1/4"</b>	<b>4-3/4"</b>	2 tons	4.9"	3/8"-24 tpi	1/8, 1/4"	1/4, 7/16"
770133	JGP-4HD	<b>3-1/2"</b>	<b>7"</b>	5 tons	7"	9/16"-20 tpi	1/4, 5/16"	3/8, 3/4"
770134	JGP-6HD	<b>5-1/2"</b>	<b>7"</b>	5 tons	7"	9/16"-20 tpi	1/4, 5/16"	3/8, 3/4"
770135	JGP-8HD	<b>5-1/2"</b>	<b>9-1/2"</b>	5 tons	9"	11/16"-18 tpi	5/16, 11/32"	7/8"

**BEARING SEPARATORS - HEAVY DUTY**

- Separator bodies made of heat treated Chrome Vanadium steel for maximum strength
- All components hardened to HRC 42~45 professional use
- Separators have knife like edges to get behind bearings where regular gear puller jaws are too thick to grip
- Can be used with push or pull type gear pullers



**12 PC Bearing Separator Set** 770302/JBS-12

- Includes components to assemble push-type puller

Maximum Reach	Capacity	Forcing Screw	Hole Size
3"	5 tons	7", 9/16" x 10 tpi	3/8" x 16 tpi

**Contents:** 2-1/4" Bearing Separator (1), 3-1/2" Bearing Separator (1), Yoke (1), Forcing Screw (1), Main Rods (4), Extension Rods (4)



**Open Stock**

PROD. NO.	MOD. NO.	Capacity	Hole Size
770312	JBS-225	<b>1-3/16" - 2-1/4"</b>	3/8" x 16 tpi
770313	JBS-350	<b>2-1/4" - 3-1/2"</b>	3/8" x 16 tpi
770314	JBS-450	<b>3" - 4-1/2"</b>	1/2" x 16 tpi





### GEAR PULLERS

See page 239 Pullers section for similar products



## GEAR PULLERS

### 22 PC Hydraulic Gear Puller Kit

770152 / JHGP-10S

- Jaws, yokes, bearing separator and ram made of heat treated Chrome Vanadium steel for ultimate strength
- Hydraulic ram requires no power - develops up to 10 tons of pressure with hand power only
- All components hardened to HRC 42~45 for professional use
- Includes twin and triple heads for assembling 2 jaw and 3 jaw pullers
- Includes 4-1/2" bearing separator
- Comes in convenient blow mould storage case

Reach	Spread	Capacity
4"	10"	10 tons

#### Contents:

Hydraulic Ram (1), 4" Puller Legs (3), 6" Puller Legs (3), 8" Puller Legs (3), Collar (1), Twin Head (1) Triple Head (1) End Cap (1), 2" Ram Extension (1), Yoke (1), 4-1/2" Bearing Separator, Main Rods (2), Extension Rods (2)



## HAND BRUSH

### Parts Cleaning Brush

H1039

- Chemical resistant bristles are crimped to hold more fluid for faster cleaning
- The bristles are tapered to get into tight places
- Plastic handle

## SCRAPERS



### Razor Blade Scraper - Folding Arm Style

H1363

- All purpose scraper
- Locks in three positions
- Handy to remove inspection stickers, paint, masking tape and general scraping jobs
- Rugged steel construction
- One steel blade included



### Razor Blades - Single Edge (100/Pack)

H1363C

- 100 per box
- Steel blades fit all single edge blade holders

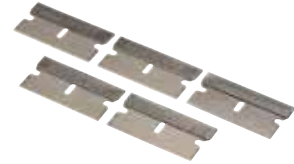

### Razor Blade Scraper - Extended Arm Style

H1364

- All purpose scraper
- Designed for hard-to-reach areas to remove inspection stickers, paint, masking tape and general purpose scraping
- Ergonomic handle with steel shaft
- One steel blade included
- Overall length: 12-1/2"
- Replacement blade: H1363C (box of 100)



### Razor Blade Scraper - Stubby Pocket Style (30 PC)

H3237DA

- Sturdy scraper for home, auto or shop
- Compact pocket size
- Remove stickers, labels, paint etc
- Colourful easy grip cushioned handle
- Uses standard single edge razor blades (see above)
- H3237DA Cookie Jar Counter Display Assortment
- Contains 30 - mini scrapers in 5 assorted coloured handles
- Cookie Jar is non-breakable plastic with snap shut lid



H3237DA

## SEAL PULLER

### Seal Puller

H3052

- Easily removes oil and grease seals on automobiles and light trucks
- Two different tips reach in and fit most seals



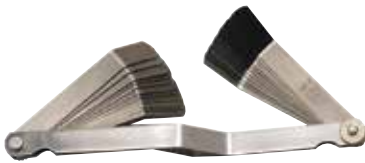

## FEELER GAUGES

### 5 Blade Non-Magnetic Feeler Gauge

H1137

- Blades made of non-magnetic brass and will not affect the electronic components of the distributor
- Five blades cover the sizes needed
- Metric equivalents marked on blade
- Blade Thickness: **.006 .008 .010 .012 .014 .016**

### 25 Blade Universal Master Gauge

H1859

- Metric equivalents marked on blades
- .0015 plus .002 to .035 in .001 increments
- Blade Size: 3-1/16" x 1/2"
- Blade Thickness: **.0015, .002, .003, .004, .005, .006, .007, .008, .009, .010, .011, .012, .013, .014, .015, .016, .018, .020, .022, .024, .025, .028, .030, .032, .035**

### 21 Blade Extra Length Offset Style Feeler Gauge

H1863

- Blade Sizes: 4" x 1/2", 1"-45° offset
- Blade Thickness: **.006 .007 .008 .009 .010 .011 .012 .013 .014 .015 .016 .017 .018 .019 .020 .021 .022 .023 .024 .025 .026**

### 22 Blade Go, No-Go Style Feeler Gauge

H3105

- Blade Sizes: 3" x 1/2" Step Ground
- Blade Thickness: **.004-.006 .005-.007 .006-.008 .007-.009 .008-.010 .009-.011 .010-.012 .011-.013 .012-.014 .013-.015 .014-.016 .015-.017 .016-.018 .017-.019 .018-.020 .019-.021 .020-.022 .021-.023 .022-.024 .023-.025 .024-.026 .025-.027**





H3370

- Heat-treated steel, black oxide finish to prevent corrosion
- Use with 3/8" square drive ratchet
- Tough, durable, built to last
- Wrenches are specifically designed for 1 or 2 step models, fitting various flute designs on Fram, AC, Casite, Lee, Hastings, Motorcraft, NAPA, Purolator, STP, Pure One, Wix and some Japanese and European made filters



## 14 PC Cap Style Filter Wrench Set

H3370

### Contains:

PROD. NO.	Metric Size	Decimal Equivalent	Flutes
H3371	74/76 mm	2.91/3.0"	15 - 2 steps
H3372	76 mm	3.00"	14
H3373	93 mm	3.66"	15
H3374	73 mm	2.875"	14
H3375	65/67 mm	2.56/2.63"	14 - 2 steps
H3376	68 mm	2.68"	14
H3377	80 mm	3.15"	15
H3378	90 mm	3.54"	15
H3379	80/82 mm	3.15/3.23"	15 - 2 steps
H3380	93 mm	3.66"	36
H3381	75/77 mm	2.95/3.03"	15 - 2 steps
H3382	65 mm	2.56"	14
H3383	76 mm	3.00"	30
H3384	100 mm	3.937"	15

## Cap Style Filter Wrench - Dual Size

H1099

- For installing or removing oil filters
- Fits most makes and models of filters with fluted ends. Won't damage filter
- Steel / nickel plated uses 3/8" square drive socket wrench or 1" open end wrench to operate
- Dual Size for 2-7/8 - 3"
- Compact Size Filters - 15 Flutes

## 14 PC 3/8" DR Oil Drain Plug Socket Set

H3700

- Fits oil drain plugs on most domestic, European and Asian vehicles
- Great for oil change professionals
- Bright-finished Chrome Vanadium steel sockets comes on a metal clip rail



### Contains:

H3700-10	3/8" Dr. Oil Drain Plug Socket (8 mm Hex)
H3700-11	3/8" Dr. Oil Drain Plug Socket (9 mm Hex)
H3700-12	3/8" Dr. Oil Drain Plug Socket (10 mm Hex)
H3700-13	3/8" Dr. Oil Drain Plug Socket (12 mm Hex)
H3700-14	3/8" Dr. Oil Drain Plug Socket (14 mm Hex)
H3700-15	3/8" Dr. Oil Drain Plug Socket (17 mm Hex)
H3700-16	3/8" Dr. Oil Drain Plug Socket (10 mm Square)
H3700-17	3/8" Dr. Oil Drain Plug Socket (7 mm Square)
H3700-18	3/8" Dr. Oil Drain Plug Socket (8 mm Square)
H3700-19	3/8" Dr. Oil Drain Plug Socket (11 mm Square)
H3700-20	3/8" Dr. Oil Drain Plug Socket (13 mm Square)
H3700-21	3/8" Dr. Oil Drain Plug Socket (5/6" Square)
H3700-22	3/8" Dr. Oil Drain Plug Socket (3/8" Square)
H3700-23	3/8" Dr. Oil Drain Plug Socket (10 mm Triangle)



## 4 PC Oil Filter Canister Socket Set

H3702

- Specially designed low profile 3/8" sq. drive sockets used for removing oil filter canister cover on vehicles that have limited access
- Cartridge type oil filters are easier to change with these specialty sockets
- When using a conventional socket, the top side of the socket can contact other surrounding components which could cause damage or make it difficult to completely remove the oil canister cover
- Made from Chrome Vanadium Steel (CRV)
- Not for use with impact tools
- Contains:

H3702-10	Oil Filter Canister Socket (24 mm)
H3702-11	Oil Filter Canister Socket (27 mm)
H3702-12	Oil Filter Canister Socket (32 mm)
H3702-13	Oil Filter Canister Socket (36 mm)



**Band Type Filter Wrench - Non-Swivel Handle****H1014**

- Stainless steel band is 7/8" (22.2mm) wide
- Full length ergonomic cushion grip handle for comfort
- All steel handle construction, plated for rust protection
- Studs on inside of band help prevent slipping
- Farm and Fleet
- Range: **4-3/4" - 5-1/8" (120.6 - 130.1 mm)**

**Band Type Filter Wrenches - Swivel Handle**

- Features a self-locking bolt in the handle instead of a rivet for less wear and tear
- Stainless steel band is 1" (25mm) wide, supported on the outside joint
- Full length ergonomic cushion comfort grip handle for comfort
- All steel handle construction, plated for rust protection
- Studs on inside of band help prevent slipping



PROD. NO.	Type	Range
H1060	Small	<b>2-3/8" - 2-7/8" (60.3 - 73 mm)</b>
H1061	Compact	<b>2-7/8" - 3-3/8" (73 - 85.7 mm)</b>
H1062	Standard	<b>3-3/8" - 3-3/4" (85.7 - 95.2 mm)</b>
H1063	Large	<b>3-3/4" - 4-3/8" (95.2 - 111.1 mm)</b>

**Band Type Truck Filter Wrenches - Swivel Handle**

- Designed for use on Cummins, Detroit Diesel and Caterpillar engines
- Has a self-locking bolt so that wear can be taken up after long use
- Steel bands one full inch wide
- Full length cushion grip handle for comfort
- Studs on inside of band help prevent slipping



PROD. NO.	Type	Range
H3433	Cummins & Detroit Diesel Engines	<b>4-5/16" - 4-3/4" (110 - 120 mm)</b>
H3434	Caterpillar Engines	<b>5-1/4" - 5-3/4" (134 - 146 mm)</b>

**Expandable Filter Wrench****H3055**

- Removes all passenger car and light duty truck spin on type oil filters
- Serrated legs provide strong gripping power
- Range: **2-3/8" - 4-3/4" (60.3 - 120.7 mm)**
- Use with 3/8" square drive



H3078



H3055

**1/2" Square Drive Oil Filter Wrenches - Heavy Duty**

PROD. NO.	Range
H3078	<b>4-1/8" - 4-21/32" (104 - 118 mm)</b>
H3079	<b>4-21/32" - 5-5/32" (118 - 131 mm)</b>
H3090	<b>5-5/32" - 5-21/32" (131 - 144 mm)</b>

**Strap Filter Wrench - Standard****H1295**

- For installing or removing oil filters
- Adjusts quickly to oil filter. Use with square drive ratchet handle or open-end wrench
- Strap is made of a durable oil resistant nylon web that will not slip
- For cars and trucks: 6" capacity
- 1/2" square drive or 3/4" open-end wrench

**Heavy Equipment Band/Strap Filter Wrench****H3241**

- Heavy duty cordura strap for high torque requirements
- Tightening and turning device has 3/8" square drive on one end and 1/2" square drive on the other
- Range up to **9" (228 mm)** approx.
- Strap length approx. 25"

**Oil Filter Removal Pliers****H3310**

- For removal and installation of spin-on oil and fuel filters
- Self-adjustable. Spring action slip joint. Gripping jaws and cushion grip handles
- Range: **2-1/4" - 6" (60 - 152 mm)**



## DRIVER BITS AND SOCKETS



### 4 PC Triple Square Driver Bit Set

H1456

- For use on 12 point fasteners
- Triple square design. Alloy steel
- Made from Chrome Vanadium 6150
- 50 - 54 Rockwell Hardness

**Contains:** Bit size 6, 8, 10, 12 mm



### 8 PC 3/8" DR Triple Square Driver Bit Set

H1458

- Black oxide tip, matte finish and made from SNCM 8660 steel
- For use on triple square fastener bolts typically found on European vehicles (especially German)
- For use on cylinder heads, axle shafts, rear toe adjusters, differentials, transmission drain plugs, clutches, belly pans, brake calipers and more
- Other uses include: Detroit Diesel® flywheel bolts, crank pullers on 900 & 4000 series engine, and headbolts on 900 series
- Bit sockets are NOT designed for use with power impact tools

**CAUTION:** Triple square bit sockets may strip the head of double hex bit fasteners found on many Asian vehicles



	Socket Size		Socket Size
H1458-10	4 mm	H1458-14	10 mm
H1458-11	5 mm	H1458-15	12 mm
H1458-12	6 mm	H1458-16	14 mm
H1458-13	8 mm	H1458-17	16 mm

## STUD, BOLT AND NUT REMOVAL

### Nut Splitting Tool

H1858

- For removal of rusted or corroded nuts. It will split nuts up to 3/4" across flats, just a few turns with any 3/4" hand wrench (no power needed)
- Especially handy for front and rear shock absorber stud-end nuts
- Overall length: **4-1/8"**



H1858

## PUNCHES - BRASS

- Ideal when sparks from a steel punch would be dangerous
- A must for those driving jobs where a soft punch is required

### Tapered Punch (5/8" Hex to 3/8" Point)

H3095



H3095

### Drift Punch (3/4" Diameter - Knurled Grip)

H3096



H3096

## PLIERS

### Universal Lock Ring Pliers

H3056

- Removes and installs lock rings used on brakes, transmissions, pedal shafts and clutch shafts
- The scored jaws hold rings securely



H3056



## SCREWDRIVERS



### 15-in-1 Multi Bit Screwdriver

H3400

- Features a patented pullout bit cartridge
- 14 of the most popular bits means one multi-driver replaces 14 screwdrivers and one 1/4" hex nut driver
- 2" double end bits are made of superior quality S2 steel for strength and durability
- Shaft is made of super high strength 12T14 steel for long life
- End of shaft is a 1/4" hex nut driver
- Handle is made of durable nylon reinforced triax resin for longest life.
- Unique rotating cap design allows you to position the cap in the palm of your hand and rotate the driver handle with your fingers. The driver then acts like a gearless ratcheting screwdriver, increasing productivity while reducing blisters and operator fatigue
- Collar also swivels 360° for fast, efficient driving of screws
- Made in the U.S.A.

**Distributors please note: Drivers are sold in 6 pack POP displays only.**

#### REPLACEMENT BITS:

H3400C	PH 1+PH3
H3400D	PH1+PH2
H3400E	S1+S2
H3400K	S0+S3
H3400J	F4+F6
H3400F	T10+T15
H3400G	T20+T25
H3400H	T27+T30



## SCREW EXTRACTORS

### 5 Piece Flute Type Screw Extractor Set

H1273

- Five extractors with sharp undercut edges to provide solid grip in studs, set screws, pipes and zerk fittings
- Made from Chrome Molybdenum (50 - 52 Rockwell hardness)



#### Contains:

	U.S.S. Screw or Bolt Size	Drill Size	Min. Depth of Hole	Pipe Size
H1273A	1/4", 5/16"	1/8"	3/8"	
H1273B	3/8"	3/16"	1/2"	
H1273C	7/16"	15/64"	1/2"	1/8"
H1273D	1/2", 9/16"	5/16"	1/2"	1/4"
H1273E	5/8"	3/8"	5/8"	3/8"



### 5 Piece Spiral Type Screw Extractor Set

H1365

- For removing broken screws, bolts and threaded parts
- Spiral type flutes grip and remove the broken part
- Precision Chrome Molybdenum (48-52 Rockwell hardness), tapered and ground
- Comes in a convenient vinyl pouch



#### Contains:

	Screw or Bolt Size	Drill Size
H1365A	1/8 - 1/4"	1/16"
H1365B	1/4 - 5/16"	7/64"
H1365C	5/16 - 7/16"	5/32"
H1365D	7/16 - 9/16"	7/32"
H1365E	9/16 - 3/4"	17/64"



**WARNING:** Always wear safety goggles

**Thread File (Coarse SAE) H1440**

- **11, 12, 13, 14, 16, 18, 20, 24** (threads/inch)

**Thread File (Fine SAE) H1441**

- **9, 10, 12, 16, 20, 27, 28, 32** (threads/inch)

**Thread File (Metric) H1442**

- **0.75, 1.0, 1.25, 1.50, 1.75, 2.00, 2.50, 3.00 mm**



H1440 - H1442

**Threaded Die Sets**

- Hex shape lets you use a common socket for a holder
- Will quickly and safely repair damaged threads on bolts or rods
- Each set packed on ball chain



PROD. NO.	Pieces	Type	Contents
H1345	7	Fine	<b>1/4, 5/16, 3/8, 7/16, 1/2, 9/16, 5/8</b>
H1346	5	Metric	<b>6 mm x 1.0, 7 mm x 1.0, 8 mm x 1.25, 10 mm x 1.50, 12 mm x 1.50</b> <b>Use H1346-11 for 7 mm x 1.0 Die</b>

**43 PC Rethreading Die Set – SAE/Metric H3573**

- A comprehensive re-thread kit for repairing or renewing damaged threads on nuts, bolts or studs
- Hex-shaped for socket or wrench use
- Comes in a convenient blow mould storage case

21 DIES		19 TAPS		3 Thread Files (4 sided)		
<b>UNC - National Coarse (Silver)</b>		<b>UNC - National Coarse (Silver)</b>		<b>H1440</b>	SAE	Coarse <b>11, 12, 13, 14, 16, 18, 20, 24</b>
<b>H3573-10</b>	1/4"-20 UNC	<b>H3573-17</b>	1/4"-20 UNC	<b>H1441</b>	SAE	Fine <b>9, 10, 12, 16, 20, 27, 28, 32</b>
<b>H3573-11</b>	5/16"-18 UNC	<b>H3573-18</b>	5/16"-18 UNC	<b>H1442</b>	Metric	<b>0.75, 1.00, 1.25, 1.50, 1.75, 2.00, 2.50, 3.00 mm</b>
<b>H3573-12</b>	3/8"-16 UNC	<b>H3573-19</b>	3/8"-16 UNC			
<b>H3573-13</b>	7/16"-14 UNC	<b>H3573-20</b>	7/16"-14 UNC			
<b>H3573-14</b>	1/2"-13 UNC	<b>H3573-21</b>	1/2"-13 UNC			
<b>H3573-15</b>	9/16"-12 UNC	<b>H3573-22</b>	9/16"-12 UNC			
<b>H3573-16</b>	5/8"-11 UNC	<b>UNF - National Fine (Black)</b>				
<b>UNF - National Fine (Black)</b>		<b>H3573-30</b>	1/4"-28 UNF			
<b>H3573-23</b>	1/4"-28 UNF	<b>H3573-31</b>	5/16"-24 UNF			
<b>H3573-24</b>	5/16"-24 UNF	<b>H3573-32</b>	3/8"-24 UNF			
<b>H3573-25</b>	3/8"-24 UNF	<b>H3573-33</b>	7/16"-20 UNF			
<b>H3573-26</b>	7/16"-20 UNF	<b>H3573-34</b>	1/2"-20 UNF			
<b>H3573-27</b>	1/2"-20 UNF	<b>H3573-35</b>	9/16"-18 UNF			
<b>H3573-28</b>	9/16"-18 UNF	<b>Metric (Gold)</b>				
<b>H3573-29</b>	5/8"-18 UNF	<b>H3573-43</b>	6 mm x 1.00			
<b>Metric (Gold)</b>		<b>H3573-44</b>	8 mm x 1.25			
<b>H3573-36</b>	6 mm x 1.00	<b>H3573-45</b>	10 mm x 1.25			
<b>H3573-37</b>	8 mm x 1.25	<b>H3573-46</b>	10 mm x 1.50			
<b>H3573-38</b>	10 mm x 1.25	<b>H3573-47</b>	12 mm x 1.25			
<b>H3573-39</b>	10 mm x 1.50	<b>H3573-48</b>	12 mm x 1.50			
<b>H3573-40</b>	12 mm x 1.25	<b>H3573-49</b>	12 mm x 1.75			
<b>H3573-41</b>	12 mm x 1.50					
<b>H3573-42</b>	12 mm x 1.75					



**WARNING:** Do not use with impact or power tools





## POST AND TERMINAL SERVICE

### 5/16" Side Terminal Wrench

H3125



- Designed to easily remove 5/16" side terminal battery bolts
- Insulated handle to prevent electrical shock
- Reversible 5/16" ratcheting box wrench allows for quick and effective terminal bolt removal

### Post and Terminal Cleaning Brush

H1007



- Remove corrosion quickly and safely. Cleans battery post and terminals for perfect electrical contact
- Also useful as a wire cleaning brush for cleaning 1/2" copper pipe before sweating
- Metal case included

### Post and Clamp Cleaner

H1677



- Quickly and safely cleans even the most corroded terminals
- Double ended post cleaner handles both the positive and negative posts
- The tapered reamer cleans both size terminals
- Constructed of high quality steel and shock proof plastic

### Post and Terminal Cleaner

H3391



- Cleans and reams battery posts and terminals
- Post cleaners marked with positive and negative symbols for easy identification

## BATTERY CARRIER

### Grip-Tight Battery Carrier

H1279



- For most 6 and 12 volt batteries
- Rugged, zinc plated steel jaws grip battery securely for lifting
- Acid resistant, non-conductive strap
- Designed to carry side terminal or post batteries
- Easy one hand control

## 100 Amp Analogue Load Tester

H3432

- **Tests 6 and 12 volt batteries up to 1,000 CCA**
- Tests battery state of charge, battery cranking ability, charging system output and starter condition
- Easy to read meter
- Accurate and shock resistant movement
- Heavy duty colour coded, insulated clamps
- Durable, ventilated blue enamel steel case
- Top mounted rocker switch is more convenient and easy to use
- Rubber insulated carrying handle for both comfort and safety
- Complete tests done in 10 seconds
- Outside power is not required
- True 100 amp load capacity
- Unit does not contain asbestos



## 100 Amp Digital Load Tester

H3650

- **Test 12 volt batteries only up to 1,000 CCA**
- Tests: battery state of charge, battery cranking ability, charging system output starter test
- Microprocessor controlled design guarantees an easy and accurate load test and no need to time yourself
- Unique 3 step design: LED polarity checking function, battery state of charge and charging system test readout
- Check both battery and charging systems
- Durable, ventilated enamel steel case
- Completely portable; outside power is not required
- True 100 amp load capacity



## 500 Amp Carbon Pile Tester

H3655

- **Tests batteries up to 1,000 CCA**
- For **12 volt batteries**, alternators, regulators & starters systems
- Colour-coded, temperature compensation pass/fail bands on the voltmeter insures precise battery load test results
- Separate voltmeter and ammeter, for easy monitoring
- Fully insulated, heavy duty, colour coded battery clamps & wire leads
- Designed with built in 15 second load warning beeper
- Meets UL and CE standards
- The JET ADVANTAGE: There are many 500 amp carbon pile battery tester and charging system analyzers in the market. While they all look the same from the outside, our unit has many important features that ensure a premium quality tester. Our carbon piles are made from the best quality, superior performing materials. Our steel parts are made with patented "constant-pressure/constant current" steel. The fasteners and soldering materials and assembly technology insure the components and connection stay secure. We use heavy duty 4 gauge welders' grade cable wire where competitors may use lighter gauge cable. These superior components and design qualities offer greater stability and more accurate readings while minimizing heat build up





## ELECTRIC TESTERS

### Circuit Tester – 6/12 Volt

H1090

- Test electrical circuits, relays, bulb, and switches
- Attach the ground clip to any good electrical ground and touch the probe to the hot end. If the bulb lights up, the circuit is good
- Bulb will take a nominal overload for safety
- Uses standard replacement bulb
- Hi-impact, no shock, plastic case
- H1090C replacement bulb

### Continuity Tester

H1304

- Self-powered tester will check all voltage circuits and wiring, with the vehicle power off
- Uses standard AA battery. Battery included
- Test radio, T.V., appliances, electrical circuits, switches, voltage regulators, coils, fuses, condensers, armature and alternator diodes
- Bulb is mini screw base 1.5 V industry standard No. 112, purchase locally
- Lead is 36" long

### Circuit Tester – Deluxe 36 Volt

H1493

- This unit does it all. It will test all voltages from 6 - 36 volts
- A special high voltage neon tube will also let you test spark plugs and spark plug wiring
- The coiled wire lead extends up to 6 feet and retracts compactly
- Heavy duty large type clamp
- A very good all around tester
- H1090C replacement Bulb

### Circuit and Polarity Tester - Computer Safe

H3068

- Designed to be used on all 12 volt circuits including automotive computer circuits without damage to sensitive electronic components
- It draws less than 21 milliamps at 12 volts DC with an operating range of 3 - 15 volts
- Has a long life LED bulb
- Glows RED to indicate positive polarity at probe and GREEN to indicate negative polarity

### Circuit Tester With Buzzer - 6/12/24 Volt

H3344

- Bulb lights and buzzer sounds when positive contact has been made
- Ideal for use in tight spaces or under bright lights where a light is difficult to see
- Tests 6 - 12 - 24 volt "power-on" circuits
- Clip enclosed in anti-shock boot
- Features long life LED bulb
- Extra long 42" 16 - gauge wire

### Remote Starter Switch

H1361

- Remote switch allows the mechanic to crank engine from outside of vehicle while keeping hands away from fan blades, gears, or other moving parts.
- Heavy duty switch contacts reduce arcing
- May be used to open and close other low voltage circuits.
- Leads are 35" long

## Ford® Triton Spark Plug Thread Repair Kit

H3660

- Designed to aide in repairing spark plug threads damaged on Ford® Triton Modular Engines - 1996-2003 - 4.6LT, 5.4LT, 6.8LT V-10
- Becoming one of the most asked for repairs as these engines age
- Repair damaged cylinder heads from spark plug thread erosion and shooting spark plugs out during operations with a patented "Alloy Steel Insert"
- Foolproof repair system that is fast, cost effective and simple to use
- Takes as little as 15 minutes, to no more than 45 to repair one cylinder

### Kit Contains:

- Core drill, guide, hose assembly, instructional DVD, 6 -M14 x 1.25 x 19mm O.D. alloy inserts, all in a blow mould case
- Replacement parts: H3660-10 spark plug insert



## Ford® Triton Spark Plug Shield Extractor Kit

H3661

- Designed to extract frozen or broken spark plug ground electrode shields in Ford® Triton engines 2004 to present – 4.6LT, 5.4LT, 6.8LT V-10
- The elongated plug has a stainless steel shield – as the carbon deposit builds-up, the shield sticks and stays in the cylinder head spark plug well
- Use the specially machined guide with tap 9mm x 8" L (203.2mm) to tap the shield
- Use the extractor to pull out the stainless steel sleeve
- Problem solved; saving time and a huge expense

### Kit Contains:

- 1 each: guide, Tap 9mm x 8" L (203.2mm), extractor, nut, washer and 4 rubber stopper caps, all in a blow mold case



## Ford® Triton Spark Plug Porcelain Extractor Kit

H3659

- Designed to extract frozen or broken porcelain part of the spark plug in the 3 Valve Ford Triton engines (2004 to present)
- Using these special tools and a strong epoxy you should be able to extract the broken porcelain left behind when spark plug removal was attempted
- The advantage of this method of extraction is to prevent broken pieces of porcelain from entering the combustion chamber
- Ford specifically does NOT recommend pushing the broken porcelain down into the cylinder, doing so would mean the removal of the cylinder head

### Kit Contains:

- 1 - Epoxy applicator with guide, 1 - epoxy electrode applicator and extractor assembly, 1 - Small tube of bonding epoxy (Loctite)
- Replacement epoxy. Use Loctite No. 638 or Permatex No. 64000 or 64050
- Replacement parts: H3659-10 epoxy applicator  
H3659-11 epoxy pins - 10 pack





## SPARK PLUG/IGNITION TOOLS

### Spark Plug Gauge and Gapper

H3116

- For standard and H.E.I. ignition
- Has tapered ground edge for gapping plugs. Adjusting hole with flange to adjust side wire without pressuring centre electrode
- Has both metric and decimal markings
- Gaps all plugs from: .020 - .100 (0.50 - 2.5 mm)

### Spark Plug Thread Chasers

H1066

- For spark plug holes
- Chaser cleans threads of dirt, carbon build-up and metal particles
- Services most applications including compacts and subcompacts
- Rubber ring holds chaser firmly in socket
- Dual Size: 14 mm and 18 mm
- Use with 13/16" deepwell socket

### 5 Piece Magnetic Spark Plug Socket Set

H3704

- Long reach magnetic swivel spark plug socket set
- For hex sizes 5/8", 13/16" and the new 9/16" on Ford® Triton engines
- Made from CrV steel, with a bright hard chrome finish

#### Set Includes:

- 3/8" Dr x **9/16" HEX x 2-1/2" (66 mm)** Long
- 3/8" Dr x **5/8" HEX x 4" (101.6 mm)** Long
- 3/8" Dr x **5/8" HEX x 6" (152.4 mm)** Long
- 3/8" Dr x **5/8" HEX x 11" (279.4 mm)** Long
- 3/8" Dr x **13/16" HEX x 6" (152.4 mm)** Long

CrV



**Digital Automotive Multimeter****H3630**

- Full-range - performs complete tune-up and troubleshooting tests on all vehicles
- Includes tests such as tach and dwell, fuel injectors, sensors, alternators, spark plug wires, ignition and charging systems, battery condition and cranking voltage
- Easy-to-read digital LCD
- Data hold function
- Computer safe

**Functions:**

DC Volts	200m-2-20-200-1000V
AC Volts	200-750V
DC Amps	20m-200m-10A
OHMS	200-2k-20k-200k
Frequency	20kHz
Dwell	3-4-5-6-8CYL
Tach	3-4-5-6-8CYL (X10RPM)
Temperature	-40° C/-40° F / 1,400° C/2,552° F
Diode check	3V/1mA
Continuity	Audible BEEP
Transistor hFE	Vce≈3v, 1b≈10μA

**Features:**

- 10M Input Impedance
- Auto reverse polarity
- Auto zero adjust
- Over range Indication
- Overload protection
- Low battery indicator
- Fuse Protection
- 9-Volt power
- Auto power off
- 9V Battery

**Accessories:**

- Colour-coded test leads
- Inductive spark pickup clamp
- Temperature Probe
- Detailed manual
- Holster

PH3630-10  
Lead SetPH3630-12  
Inductive Clamp



H1122 H1386

## MISCELLANEOUS

### Mechanics 4-In-1 Pick Set

H1244

- Good quality metal scribes designed at different angles to meet the mechanic's needs
- Comes complete with 4 picks and one master handle
- Handy storage pouch

### Telescopic Mirror (2-1/4" Round Face)

H1105

- Double ball joint links swivel mirror for viewing to 360°
- Linkage designed to withstand constant repositioning of mirror, to move freely and yet hold desired position
- Telescoping handle: **9-1/2" - 14"**

### Telescopic Pocket Mirror (1" x 2" Oval Face)

H1230

- Double ball adjustment head
- Convenient pocket clip
- Telescoping handle: **6-3/4" - 24-3/4"**

### Telescopic Mirror (Large Rectangular Face)

H3103

- Double ball joint hinge adjusts to almost any angle
- Handle end has easy grip vinyl coating
- Telescoping handle: **11" - 15-1/2"**

## MAGNETIC PICK-UP TOOLS

### Flexible Pick-Up Tool

H1080

- Bends in any direction to hold or pick up objects
- Handy squeeze action gives close control
- Mechanical fingers grip securely
- Reach: **15"**

### Adjustable Pocket Telescoping Magnet

H1386

- Extends up to **23"**
- Lifts up to **3-1/2 lb**

### Long Adjustable Telescoping Magnet

H1122

- This heavy duty Alnico magnet will lift many times its own weight
- The flex head gets into tight places
- Bright plated with a comfortable plastic handle
- Shaft telescopes from **16-3/4" - 26-3/4"**
- Lifts up to **5 lb**

### Flexible Magnetic Pick-Up Tool

H1229

- Flexible Alnico 5 magnetic pickup tool with knurled handle
- Flex shaft holds its set
- Overall length: **21"**
- Diameter: **5/16"**
- Lifts up to: **5-1/2 lb**

## TIRE PRESSURE GAUGES



### Pencil Tire Pressure Gauge - Chrome Plated

H1141

- Quality gauge ensures accuracy, long life and trouble-free performance
- High chrome plated finish
- Calibrated on two sides from **5 - 50 PSI** and in metric **40 - 350 kPa**
- Comes with handy pocket clip



### Pencil Tire Pressure Gauge - Metal Body

H3262

- Durable metal chuck and body
- Handy pencil style with pocket clip
- Four sides plastic slide bar
- Calibrated in **5 - 50 PSI** and **40 - 350 kPa**



Distributors please note :  
H3262 tire gauges sold in an  
attractive 24 pack POP display only

### Dual Chuck Tire Gauge - Small

H3162

- Accurately measures from **10 - 120 PSI**. Also calibrated in kg
- Chrome plated ABS dual offset heads
- Stem enclosed in metal body
- Shockproof
- Includes spring pocket clip
- Overall length: **6-3/4"**



### Dual Chuck Tire Pressure Gauge - Large

H1503

- Dual chuck for use on trucks and passenger cars. Will withstand rugged use
- Angled dual chuck to reach inner and outer tire valves
- Indicator bar calibrated **10/200 PSI in 2 lb increments** and **metric 1/14 kg**
- Includes hang up ring
- Overall length: **13"**





Head assembly swivels 360°

Easy to read recessed sight glass



Large LED display



## TIRE PRESSURE GAUGES

### 360° Swivel Head Truck Tire Gauge - Angle and Straight-On

H3274

- Heavy duty truck tire gauge
- Head assembly swivels 360°
- Easy-to-read, recessed sight glass
- Needle holds reading until bleeder valve is released
- High chrome plated finish
- Pressure range **10 - 120 PSI in 2 lb increments**

### 360° Swivel Head Digital Tire Pressure Gauge

H3276

- Simple to operate
- Clear, large LCD display (30mm x 15mm) with built-in backlight
- Audible buzzer
- Replaceable battery (LED), lithium and LR44 alkaline
- Measuring range to **150 PSI**
- Calibration in PSI, Bar, Kg/cm<sup>2</sup> and kPa
- Resolution: **0.5 PSI (0.05 Bar or 5 kPa)**
- Accuracy: +/- 1% + 0.5 PSI at 100 PSI and +/- 2% + 0.5 PSI at 150 PSI
- Operating Temperature: **50°F - 86°F (10°C - 30°C)**
- Head assembly swivels 360°
- Straight and 30° reverse angle chuck for monitoring inside and outside dual wheels
- 11-7/8" x 7-1/4"

- Needle holds readings until released by pressing relief button
- Zinc Alloy body, all chrome plated with acrylic lens
- Range: **10-100 PSI, in 2lb increments with metric kPa reading**
- Distributors please note: H3266 tire gauges are sold in an attractive 12 pack POP display only
- For single units order H3264

PROD. NO.	Description
-----------	-------------

H3264	Dial Type Tire Gauge
-------	----------------------

H3266	Dial Type Tire Pressure Gauge (10-100 PSI) – 12 Piece Counter Display
-------	---

## TIRE VALVE TOOLS



### Valve Core Tool - 4-in-1 Style

H1142

- Removes and replaces tire valve cores, rethreading inside and outside of valve stem
- E-Z out for backing out valve insides when shoulders are broken off
- Made of high grade tempered steel.
- Nickel plated



### Tire Tread Depth Gauge

H1151

- Accurately determines the amount of tread left on tire
- Brass construction with high chrome plated finish
- 3 sides calibrated in **1/32" increments up to 1" depth**
- 3 sides calibrated in **millimeters in increments up to 25 mm depth**
- Handy pocket clip



### Valve Core Tool

H1147

- A compact tool with aluminum handle and steel shaft
- Handle provides a sturdy grip
- For standard size valve core
- Overall length 5"



## PLIERS FOR WHEEL WEIGHTS

### Wheel Weight Pliers with Spring Loaded Handles

H1116

- Remove and install all types of clip-on wheel weights
- Invisible spring loaded handle keeps the jaws in the open position for ease of operation
- Ergonomic handle design with coated grips for comfort
- Built in cutter to cut wheel weights
- Handle ends have a flat or pointed end for prying or lifting
- Made of Chrome Vanadium steel
- Length: **9-3/4"**







Rubber protected



360° swivel easy to read gauge



H1143

H1145



H1144



H1302



H1301

## AIR INFLATOR GAUGES

### Air Line Inflator With Tire Gauge – Bayonet / Slide Type

H3282

- 2-in-1 tool, inflate and measure tire pressure levels
- Lever action
- Heavy duty construction provides long service life
- Zinc chrome plated body with brass internal parts
- 360° swivel dual foot chuck
- Includes a 1/4" x 12" air hose rated at W.P. 300 PSI
- Range: **10 - 90 PSI in 2 lb increments**

### Air Line Inflator With Tire Gauge – Dial Type

H3284

- 3-in-1 tool, air line inflator and deflator with tire pressure gauge
- Heavy duty construction provides long service life
- 360° swivel easy-to-read gauge with heavy duty rubber gauge head protector
- Includes a 1/4" x 5 foot air hose rated at W.P. 300 PSI with 360° swivel straight safety clip-on air chuck
- 1/4" NPT female
- Range: **10 - 170 PSI in 2 lb increments**  
**70 - 1200 kPa in 10 lb increments**

## AIR CHUCKS

### Single Face Air Chuck

H1143

- Direct air line chuck with shut off valve built into chuck head
- Thread size: **1/4" NPT**

### Single Face Air Chuck with Safety Clip

H1145

- Direct air line chuck with shut off valve built into chuck head
- Safety clip holds air chuck to valve stem
- Brass
- Air inlet (NPT) **1/4"**

### Straight-On air Chuck with Safety Clip

H1144

- Direct air line chuck with shut off valve built into chuck head
- Safety clip holds air chuck to valve stem
- Brass
- Thread size **1/4" NPT female**

### Dual Foot Air Chuck

H1301

- Direct air line chuck with shut off valve built into chuck head
- Thread size: **1/4" NPT**
- Overall length: **5-1/4"**

### Dual Foot Air Chuck - Angle and Straight-On

H1302

- 30° angle & straight-on chuck with deep well lock
- Locks onto valve mouth when fitted
- Chrome plated finish
- Brass tube
- Air inlet (NPT) **1/4"**
- Overall length: **6-5/8"**

## 11 PC Pry Removal Tool Set

H3662

- Designed for the disassembly of door panels, dashboards, fascia, trim strips, bezels, window installation and more
- Specially constructed of impact resistant nylon
- It will not scratch or mar delicate surfaces like some metal versions
- Comes complete in a durable canvas storage roll pouch
- The pouch forms its own standing display or lays flat for easy access to tools while on the job
- Ideal for the automotive, marine, aviation and other industries where surface care is required



### Set Includes :

- H3362-10** Angled clip panel remover
- H3362-11** Flat clip panel remover
- H3362-12** Panel remover
- H3362-13** Sharp panel remover
- H3362-19** Wide type remover
- H3362-14** Straight panel remover
- H3362-15** Clip panel remover
- H3362-16** Pull type remover
- H3362-17** Handy remover
- H3362-18** Narrow type remover
- H3362-20** Upholstery remover



## 5 PC Trim Panel Removal Set

H3664

- Variety of popular body trim panel removal tools
- Designed to prevent the trim panel fastener from pulling through the panel
- Ergonomic handle with SVCM satin chrome plated steel shafts
- Comes with a reusable storage tray

### Set includes:

- **H3666** Large V Notch Tip, Length **9"**
- **H3668** Small V Notch Tip, Length **8-1/4"**
- **H3670** 1/4" U Notch Tip, Length **8-3/4"**
- **H3672** 5/16" U Notch Tip, Length **8-3/4"**
- **H3674** Square Notch Tip, Length **9-7/8"**

SVCM





## CHROME SERIES GAUGES - PROFESSIONAL DUTY



HTA1106



HTA1109



HTA1118



HTA1125



HTA1136



HTA1150



HTA1153



HTA1154



HTA1156



HTA1216 (HTA1118, HTA1144)



HTA1308 (Includes HTA1106, HTA1118, HTA1144)

- All gauges are for 12 volt negative ground systems
- Accurate, reliable gauges, 2-1/16" dual SAE and metric dials
- Chrome bezels and panels with optional black vinyl decoration supplied
- White print and red pointers on black background. OEM backlit illuminated

### Kit includes:

- Adapters and senders to fit most popular applications
- Full installation instructions
- OHMS rating for oil pressure gauges: 0 PSI = 225 - 259 OHMS, 50 PSI = 93 - 113 OHMS, 100 PSI = 30 - 38 OHMS
- OHMS rating for electrical temperature gauges: room temp = 1,730 OHMS, 130°F = 528 OHMS, 190°F = 165 OHMS, 290°F = 36 OHMS

PROD. NO.	Description	Range	Sweep	Includes
HTA1106	Ammeter	-60-0-60+	90°	-
HTA1109	Voltmeter	8-16 Volts	90°	-
HTA1118	Mechanical Water Temperature - 66° Capillary Tube	130° - 280°F 50° - 140°C	90°	1/2" and 3/8" NPT Adapters
HTA1125	Wide Sweep Mechanical Water Temperature - 66° Capillary Tube	130° - 280°F 50° - 140°C	270°	1/2" and 3/8" NPT Adapters 74" Lead
HTA1136	Electrical Water or Oil Temperature	130° - 280°F 50° - 140°C	90°	Sender Unit
HTA1144	Mechanical Oil Pressure	0-80 PSI	90°	72" Nylon Tube with Adapters
HTA1150	Wide Sweep Mechanical Oil Pressure	0-100 PSI	270°	72" Nylon Tube with Adapters
HTA1153	Electrical Oil Pressure	0-100 PSI	90°	Sender Unit
HTA1154	Manifold Vacuum	0-25 lb	270°	72" Plastic Tube with Adapters
HTA1156	Mechanical Water Temperature - 96° Capillary Tube	130° - 280°F 50° - 140°C	90°	1/2" and 3/8" NPT Adapters

PROD. NO.	Description
HTA1216	Dual Oil Pressure & Water Temperature Gauge Set
HTA1308	Triple Ammeter, Oil Pressure & Water Temperature Gauge Set

- Designed for heavier duty and marine applications
- Cross coil torque meter and oil dampened needle movements ensure steady readings
- Built with non-corrosive, durable plastic cases, with a water resistant seal and stainless steel bezels
- 2-1/16" diameter

**Kit includes:**

- Electric gauges
- 12 volt negative ground systems
- OEM backlit illuminated
- Mounting hardware and installation instructions (non connection wires)
- Clamshell packaging
- Sender thread 1/8 - 20 NPT

PROD. NO.	Description	Range	Sweep	Includes
HTA1000	Hour Meter - Rear Mount	0-99999.9	-	-
HTA1401	Electrical Oil Pressure	0-100 PSI	180°	Sender Unit
HTA1402	Electrical Water Temperature	100°-280°F	180°	Sender Unit
HTA1403	Voltmeter	8-16 volts	180°	-
HTA1404	Fuel Level Gauge	-	180°	-

## EASY-READ GAUGE KITS WHITE FACE

- 2-1/16" dials
- OEM backlit illuminated
- SAE and metric readings
- Wide sweep for accurate readings
- Black deluxe panels and bezels
- For all 12 volt negative ground systems

**Kit Includes:**

- Adapters, installation hardware, instructions and lightening

PROD. NO.	Description	Range	Sweep	Includes
HTA1831	Mechanical Oil Pressure	0-100 PSI	270°	Sender Unit, 74" Lead
HTA1832	Ammeter	-60-0-60+	90°	-
HTA1833	Voltmeter	8-16 volts	90°	-
HTA1834	Mechanical Water Temperature	130°-280°F	270°	Sender Unit, 74" Lead
HTA1835	Triple Voltmeter, Water Temperature & Oil Pressure Gauge Set			



HTA1401



HTA1000



HTA1402



HTA1404



HTA1403



HTA1831



HTA1833



HTA1835 (Includes HTA1831, HTA1833, HTA1834)



HTA1832



HTA1834



HTA1820



HTA1819



HTA1830



## TACHOMETERS

- 0-8,000 RPM
- 270° sweep
- Illuminated
- Red adjustable kit pointer
- All metal case
- Wide chrome plated bezel
- Heavy duty cross-coil meter
- 360° universal mounting
- Works on 12 volt conventional or electronic ignition systems
- For 4, 6 or 8 cylinder applications
- Hardware and instructions included

PROD. NO.	Size	Description
HTA1819	2" Dial Compact Tachometer	White Print and Red Pointer on Black Background
HTA1820	3-1/2" Dial Tachometer	White Print and Red Pointer on Black Background
HTA1830	Easy-Read 3 1/2" Dial Tachometer	Easy Read, Black Print and Pointer on White Background

## ELECTRIC FUEL LEVEL GAUGE KIT

### Electric Fuel Level Gauge Kit

HTA1117

- Adjustable. Fits tanks 5" to 27" in depth, right or left hand swing
- Gauge design appearance and size are the same as our standard chrome series gauges
- For 12 volt negative ground system

#### Kit Includes:

- Gauge, panel and sender
- OHMS rating:  
Empty-240 OHMS  
FULL-33 OHMS

## HTA SERIES REPLACEMENT PARTS

PROD. NO.	Description
HTA1108A	12 Volt Bulb for all 2 1/16" Gauges
HTA1118A	1/2" adapter-Mech. Water Temp
HTA1118B	3/8" adapter-Mech. Water Temp.
HTA1136A	Metric Fittings - Mech. Temp. Gauges
HTA1136B	Sending Unit Kit Elect. Temp.
HTA1136C	1/8" x 1/4" adapter - Elect. Temp.
HTA1144A	Oil Press. Kit, 72" tube and adapters
HTA1144B	Oil Press. Kit, 144" tube and adapters
HTA1144C	5/16"F x 1/8" M Oil Pressure adapter
HTA1146A	Metric Fitting Kit
HTA1152A	Elect. Oil Press. Sender for HTA1153
HTA1312A	2-16" Chrome Single Gauge Panel Bezel
HTA1312B	2-16" Chrome Dual Gauge Panel Bezel
HTA1312C	2-16" Chrome Triple Gauge Panel Bezel



# PRECISION/ ELECTRONIC MEASURING TOOLS

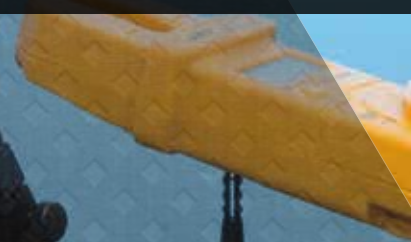

## CALIPERS

- All JET calipers feature Stainless Steel construction for professional use

### LCD Digital Calipers

- Four measurements – inside, outside, depth, step
- Extra large LCD screen is easier to read
- Professional quality hardened stainless steel construction
- Precision ground measuring surfaces
- With data output interface
- Fine adjustment thumb wheel
- Comes with high impact plastic storage case



310131

PROD. NO.	MOD. NO.	Type	Range	Increments
310131	JEDC-6	Electronic	<b>0-6"</b> (150 mm)	0.0005"/0.01 mm
310132	JEDC-8	Electronic	<b>0-8"</b> (200 mm)	0.0005"/0.01 mm
310136	JEDC-12	Electronic	<b>0-12"</b> (300 mm)	0.0005"/0.01 mm



310133

#### Four button control panel:

- power on/off switch (ON/OFF)
- zero setting at any position (ZERO)
- data hold function (HOLD)
- instant SAE / Metric conversion (MM/IN)

### LCD Digital Calipers - Fractional

310133 /JEDC-6F

- Unique LCD can display measurements in Metric, SAE and fractional formats
- Easily converts measurements with the touch of a button
- Four measurements - inside, outside, depth, step
- Professional quality hardened stainless steel construction
- Precision ground measuring faces
- Auto power off
- Fine adjustment thumbwheel



Type	Range	Increments
Electronic	<b>0-6"</b> (150 mm)	0.0005" / 0.01 mm / 1/64"

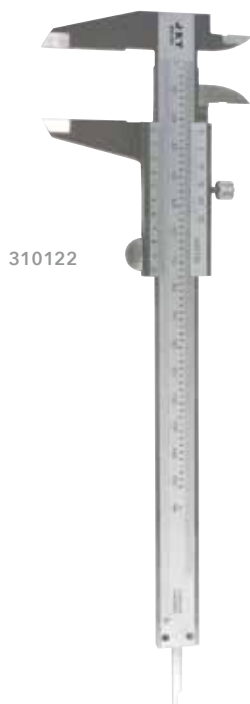

310122

### Vernier Calipers

310122 /JVC-6

- Professional quality hardened stainless steel construction
- Four measurements – inside, outside, depth, step
- SAE scale
- Permanent abrasion resistant graduations
- Satin chrome finish
- Fine adjustment thumb wheel
- Screw lock mechanism

Type	Range	Increments
Vernier	<b>0-6"</b> (150 mm)	0.001"

**Dial Indicator** 310502 / JDI-1

- Knurled bezel rotates 360°
- Stainless steel rack and contact points
- Includes revolution counter
- Back lug of indicator can be swiveled 90° for easy clamping
- Easy to read white face dial
- Range 0 – 1", increments 0.001"
- Range per revolution 0.1"

Type	Range	Increments
Dial	0 - 1" (25 mm)	0.001"

**LCD Digital Indicator** 310501 / JEDI-1

- Large LCD display for easy reading
- Stainless steel rack and contact points
- With data output interface
- Automatic power off

Type	Range	Increments
Digital	0 - 1" (25 mm)	0.0005"/0.01mm



**3 button control panel:**  
 - zero setting at any position  
 - instant inch / metric conversion  
 - data hold / max-min tracking / fast display

## MAGNETIC BASES

**Standard Style** 310902 / JMB-1

- Rod and swivel style
- On / Off switch to release magnet
- Powerful magnet holds base firmly to metal host
- 3 dimensional central locking mechanism
- Complete with fine adjustment
- Can be used with most makes of dial indicators

**Flexible Style** 310903 / JFMB-12

- 12" flexible arm holds dial indicator firmly in any position
- On / Off switch to release magnet
- Powerful magnet holds base firmly to metal host
- Stem flexes almost 360°

**Quick Set Style** 310905 / JMB-2

- Fine adjustment screw controls all 3 joints for fast set up
- On / Off switch to release magnet
- Powerful magnet holds base firmly to metal host





310206

**Five button control panel:**

- power on/off switch (ON/OFF)
- zero setting at any position (SET)
- instant SAE / Metric conversion (MM/IN)
- clock mode / data output
- absolute / incremental measurement (ABS/INC)



310210



310212



310223

## MICROMETERS

### LCD Digital Outside Micrometer

310206 / JEOM-1

- Large LCD display for easy reading
  - Precision machined carbide tipped measuring faces
  - Precision friction thimble for one hand operation
  - IP54 moisture resistant construction
  - Satin chrome finish – professional quality construction
  - 0 - 1" / 25mm range
  - 0.00005" / 0.001 mm increments
  - Comes with high impact custom plastic storage case
- Five button control panel:  
power on/off switch (ON/OFF), zero setting at any position (SET), instant SAE / Metric conversion (MM/IN), clock mode / data output, absolute / incremental measurement (ABS/INC)

### 3 OC Outside Micrometer Set

310210 / JOM-3S

- Precision machined carbide tipped measuring faces
- Precision ground and hardened one piece spindles
- Ratcheting friction stop provides uniform pressure
- Convenient lock holds spindle securely when transferring measurements
- 0.0001" increments
- Range: **0-3"**
- Contains 1 each of our **0 - 1"**, **1" - 2"**, and **2" - 3"** outside micrometers in a convenient custom made high impact plastic case
- Includes standards for both 1" - 2" and 2" - 3" models

### Outside Micrometers - Open Stock

PROD. NO.	MOD. NO.	Type	Range	Increments
310211	JOM-1	Mechanical	<b>0 - 1"</b>	0.0001"
310212	JOM-2	Mechanical	<b>1 - 2"</b>	0.0001"
310213	JOM-3	Mechanical	<b>2 - 3"</b>	0.0001"

### Depth Micrometer - Mechanical (0-6")

310223 / JDM-6

- Interchangeable extension rods feature precision lapped ends
- Ratcheting friction stop provides uniform pressure
- 4" precision ground hardened base
- 0.001" increments
- Satin chrome finish – professional quality construction
- Comes with high impact custom plastic storage case

Type	Range	Increments	Base Width
Mechanical	<b>0 - 6"</b>	0.001"	4"

**Dial Bore (Cylinder) Gauge**

310511 /JBG-6

- Used to measure the internal dimensions of work pieces such as cylinders, piping, tubing, etc.
- Allows cylinder wear measurements without removing pistons
- Unique guiding device that facilitates self centering
- Interchangeable extension anvils allow unit to measure a wide range of dimensions: SAE 2" - 6"
- Extremely accurate
- Measures bores up to 6" deep
- Easy to read white face dial
- Comes with high impact custom plastic storage case

Measuring Range	Maximum Depth	Number of Anvils	Increments
2" - 6"	6"	11	0.0005"



310511





- Four button control panel:**
- power on / off switch (ON/OFF)
  - zero setting at any position (SET)
  - instant SAE / Metric conversion (MM/IN)
  - data hold function (HOLD)

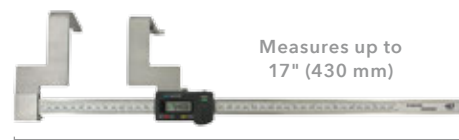

- Four button control panel:**
- power on / off switch (ON/OFF)
  - zero setting at any position (SET)
  - instant SAE / Metric conversion (MM/IN)
  - data hold

## BRAKE AND ROTOR TOOLS

- All JET Brake and Rotor tools feature stainless steel construction for professional use

### LCD Digital Disc Brake (Rotor) Caliper

310602 /JERG-1

- The ideal way to measure disc brake rotor thickness
- Both anvils are pointed to measure score depths
- With data output interface
- 0.0005" / 0.01 mm increments
- Comes with custom plastic case
- Range: **0 - 5"** (0 - 125 mm)
- Increments: 0.0005" / 0.01 mm

### LCD Digital Drum Caliper

310604 /JEDG-1

- The ideal method to measure wear on brake drums
- 0 - 20" (500 mm) range
- With data output interface
- 0.0005" / 0.01 mm increments
- Comes with custom wood case
- Range: **0 - 20"** (0 - 500 mm)
- Increments: 0.0005" / 0.01 mm

### LCD Digital Rotor Caliper (Wheel Stays On)

310603 /JERG-1WO

- For measuring disc brake rotor thickness without taking off the wheels
- Saves time and effort, increasing productivity
- All other features same as electronic rotor gauge (**310602**)
- 0 - 100 mm range
- Range: **0 - 4"** (0 - 100 mm)
- Increments: 0.0005" / 0.01 mm

### LCD Digital Drum Caliper (Wheel Stays On)

310605 /JEDG-1WO

- For measuring wear on brake drums without taking the wheels off
- Saves time and effort, increasing productivity
- 0 - 17", 0 - 430 mm range
- 0.0005" / 0.01 mm increments
- Comes with custom wood case
- Range: **0 - 17"** (0 - 430 mm)
- Increments: 0.0005" / 0.01 mm

# THERMOMETERS



If you are in the trades, we have the quality and performance you need to get the job done right.

## Non-Contact Infrared

- Allows accurate measurement of temperature without contact
- Gives instant readouts in real time
- Ideal for use in inaccessible areas and where moving parts or high heat make contact measurement dangerous
- Thousands of uses including automotive applications, food and beverage industries, chemical industries, cement plants, road building, HVAC, pool maintenance, etc.

PROD. NO. MOD. NO.	310016 JIRT-450	310018 JIRT-750
Display	3-1/2 digit (1999 count) LCD with back lighting	3-1/2 digit (1999 count) LCD with back lighting
Measuring Range	<b>-20°C to 450°C</b> <b>-4°F to 842°F</b>	<b>-50°C to 750°C</b> <b>-58°F to 1,382°F</b>
Increments	1°C / °F	0.1°C / °F up to 200°C / °F 1°C / °F over 200°C / °F
Accuracy	+/- 2°C or 2% of reading	+/- 2°C or 1.5% of reading
Operating Temperature	0°C to 50°C / 32°F to 122°F	0°C to 50°C / 32°F to 122°F
Response Time	1 sec app.	1 sec app.
Field of View (Distance : Spot Size)	8:01	12:01
Spectral Response	6 - 14µm	8 - 14µm
Emissivity	0.95 fixed	0.95 fixed
Relative Humidity (Operating)	Max. 80%	10% - 90%
Over Range Indication	LCD will show "OVER" and meter will beep	LCD will show "1"
Power Off	Automatic shut-off after 7 sec.	Automatic shut-off after 7 sec.
Power Supply	9V battery	9V battery
Weight	180 gram	290 gram
Size	159 x 79 x 57.2 mm	100 x 56 x 230 mm



310018



310016



310006



310008

## MULTIMETERS - DIGITAL

- Versatile meters for a wide range of electrical tests
- Features auto shut-off, large LCD display, low battery indicator, overload protection
- TPR shroud protects meter
- Can be used with clamp on adapter for expanded versatility
- Includes test leads, K-type thermo-coupler and 9V battery

### Multimeter

- Designed to safety standard IEC-1010; CAT II 600V

<b>PROD. NO.</b>	310006
<b>MOD. NO.</b>	JDMM-200
<b>Application</b>	AC/DC current AC/DC voltage resistance capacitance frequency temperature diode check transistor hFE
<b>AC Current</b>	20u-20m-200m-20A
<b>DC Current</b>	20m-200m-20A
<b>AC Voltage</b>	20-200-750V
<b>DC Voltage</b>	200m-2-20-200-1000V
<b>Resistance</b>	200-2k-20k-200k-2M-20M-200M ohms
<b>Frequency</b>	2k-20kHz
<b>Diode Check</b>	2.8V/1mA
<b>Capacitance</b>	2n-20n-200n-2u-20uF
<b>Temperature</b>	-40°C - 1000°C
<b>hFE</b>	Vce ~3V; 1b ~ 10Ua

### Multimeter - Auto Ranging

- Automatically sets correct range when test function is selected
- Mechanically prevents incorrect connection of test leads
- Data hold function
- Designed to safety standard EN61010-1; CAT II 600V

<b>PROD. NO.</b>	310008
<b>MOD. NO.</b>	JDMM-300
<b>Application</b>	AC/DC current AC/DC voltage resistance capacitance frequency temperature diode check duty cycle continuity check
<b>AC Current</b>	400u-4000u-40m-400m-4A-20A
<b>DC Current</b>	400u-4000u-40m-400m-4A-20A
<b>AC Voltage</b>	400mV-4V-40V-400V-750V
<b>DC Voltage</b>	400mV-4V-40V-400V-1000V
<b>Resistance</b>	200-4k-40k-400k-4M-40M ohms
<b>Frequency</b>	9.999Hz - 9.999MHz
<b>Diode Check</b>	Test current of 0.3mA, open circuit voltage of 1.5V
<b>Duty Cycle</b>	0.1% - 99.9%
<b>Continuity Check</b>	Threshold 30 ohms, continuity beeper 2.7 kHz
<b>Capacitance</b>	40nF-400nF-4uF-40uF-100uF
<b>Temperature</b>	-20°C - 760°C

**Automotive Multimeter**

H3630

- Full-range - performs complete tune-up and troubleshooting tests on all vehicles
- Includes tests such as tach and dwell, test fuel injectors, sensors, alternators, spark plug wires, ignition and charging systems, battery condition and cranking voltage
- Easy-to-read digital LCD
- Data hold function
- Computer safe



**Clamp Meter**

- Takes measurements directly through clamp or with test leads
- Designed to safety standard IEC - 1010; CAT II 600V
- Includes zipper case, test leads and 9 volt battery

PROD. NO. 310022  
MOD. NO. JDCM-2

Application	AC/DC current AC/DC voltage resistance frequency
AC Current	4A - 1000A
DC Current	4A - 1000A
AC Voltage	750V
DC Voltage	1000V
Resistance	200 kOhms
Frequency	2kHz



**Voltage Detector**

310041 / JVD-600

- Non-contact detection of AC voltage from 100V to 600V
- Suitable for testing outlets or against cable insulation
- Flashing red LED and audible beep indicate voltage
- Built in LED flashlight and pocket clip
- Designed to safety standard CATIII 1,000V
- Always test on known live circuit before use









# MECHANIC'S TOOLS



**325**



## CHISEL POINT SCRAPERS

- Extra stiff stainless steel blades with chisel points for the toughest scraping and cleaning jobs
- Ergonomic handle provides non-slip grip and maximum user comfort
- Blades double-riveted to handles for maximum strength
- Steel striking cap for extra tough scraping jobs



859341

### 4 PC Chisel Point Scraper Set

859341 / JCS-4S

- 1-1/4" Scraper
- 1-1/4" Bent Scraper
- 2" Scraper
- 3/4" Stubby Scraper

### Chisel Point Scrapers - Open Stock

PROD. NO.	MOD. NO.	Description	Blade Thickness
859342	JCS-125	1-1/4" Scraper	2.0mm
859343	JCS-125B	1-1/4" Bent Scraper	2.0mm
859344	JCS-200	2" Scraper	2.0mm
859345	JCS-2025	3/4" Stubby Scraper	2.5mm

- Exclusive ergonomic handle for maximum grip
- Premium grade Chrome Vanadium steel shafts
- Heat treated for maximum strength
- Heavy duty professional quality

### 5 PC Scraper Set

- Black Manganese Phosphate finish for corrosion resistance
- Precision ground edges

PROD. NO.	MOD. NO.	Length	Contents
859304	JPSS-5	1" x 8-1/2" 1/2" x 10" 1" x 12" 9" 7-1/2"	Short Scraper Medium Scraper Long Scraper Cotter Key Puller Radiator Hose Hook



### Hook Sets - Heavy Duty

- Nickel Chrome plated finish for corrosion resistance
- Extra long for maximum reach

PROD. NO.	MOD. NO.	Length	Pieces	Contents
859301	JPHS-604	6"	4	Straight Pick Bent Hook 90° Hook Compound Hook
859302	JPHS-904	9-3/4"	4	Straight Pick Bent Hook 90° Hook Compound Hook



### Open Stock

PROD. NO.	Length	Type	Contained in Set
859305	8-1/2"	1" Scraper	859304
859306	10"	1/2" Scraper	859304
859307	12"	1" Scraper	859304
859308	9"	Cotter Key Puller	859304
859309	7-1/2"	Radiator Hose Hook	859304
859310	6"	Straight Pick	859301
859311	6"	90° Pick	859301
859312	6"	Compound Hook	859301
859313	6"	Bent Hook	859301
859314	9-3/4"	Straight Pick	859302
859315	9-3/4"	90° Pick	859302
859316	9-3/4"	Compound Hook	859302
859317	9-3/4"	Bent Hook	859302

7-1/2" 9" 12" 10" 8-1/2"



859304



859301

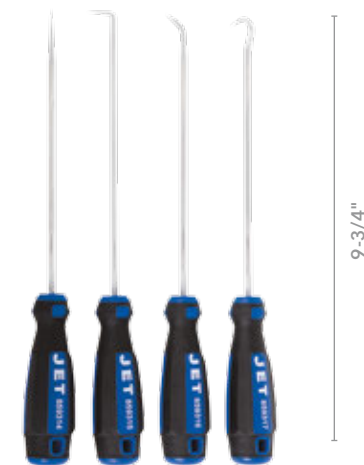

859302



## PRY BARS - HEAVY DUTY

- Chrome Molybdenum steel for maximum strength
- Super large sizes for the heaviest duty applications
- Extra large bi-material handles provide exceptional grip and comfort and allow the use of both hands for maximum leverage
- "Go-thru" shanks with steel end caps
- Available separately or in 4 piece sets

### 4 PC Cushion Grip Set

779220 / JMPB-4S

- Regular Length: **8" - 25°, 12" - 25°, 18" - 25°, 24" - 25°**

CrMo

### 4 PC Jumbo Cushion Grip Set

779240 / JHPB-4S

- Jumbo length: **24" - 70°, 24" - 90°, 36" - 25°, 36" - straight**
- Blow mould case

CrMo



Extra large bi-material handles

### Cushion Grip Type - Open Stock

PROD. NO.	MOD. NO.	Description	Type	Contained in Set
779221	JMPB-8	<b>8" - 25°</b>	Regular	779220
779222	JMPB-12	<b>12" - 25°</b>	Regular	779220
779223	JMPB-18	<b>18" - 25°</b>	Regular	779220
779224	JMPB-24	<b>24" - 25°</b>	Regular	779220

### Jumbo Cushion Grip Type - Open Stock

PROD. NO.	MOD. NO.	Description	Type	Contained in Set
779241	JHPB-2445	<b>24" - 70°</b> narrow face	Jumbo	779240
779242	JHPB-2490	<b>24" - 90°</b> wide face	Jumbo	779240
779243	JHPB-3645	<b>36" - 25°</b> wide face	Jumbo	779240
779244	JHPB-3600	<b>36" - straight</b> wide face	Jumbo	779240



Chrome Molybdenum Steel is stronger than CrV or Carbon Steel



**4 PC Rolling Head Pry Bar Set** 859211 / JRPB-4S

- Rounded head acts as a fulcrum to provide extra leverage
- Tapered point and round stock ideal for aligning parts through bolt holes
- Heat treated Chrome Vanadium steel for professional use
- Magnetic particle tested to ensure complete material integrity
- Electrostatic powder coat paint protects against corrosion
- Includes: **6, 12, 16, 20"**

CrV

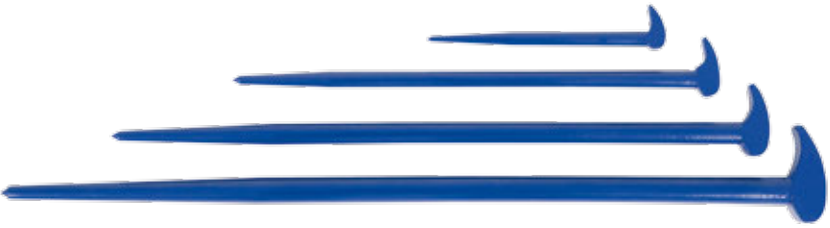

**Rolling Head Pry Bars - Open Stock**

PROD. NO.	Length	Contained in Set
859212	6"	859211
859213	12"	859211
859214	16"	859211
859215	20"	859211

CrV

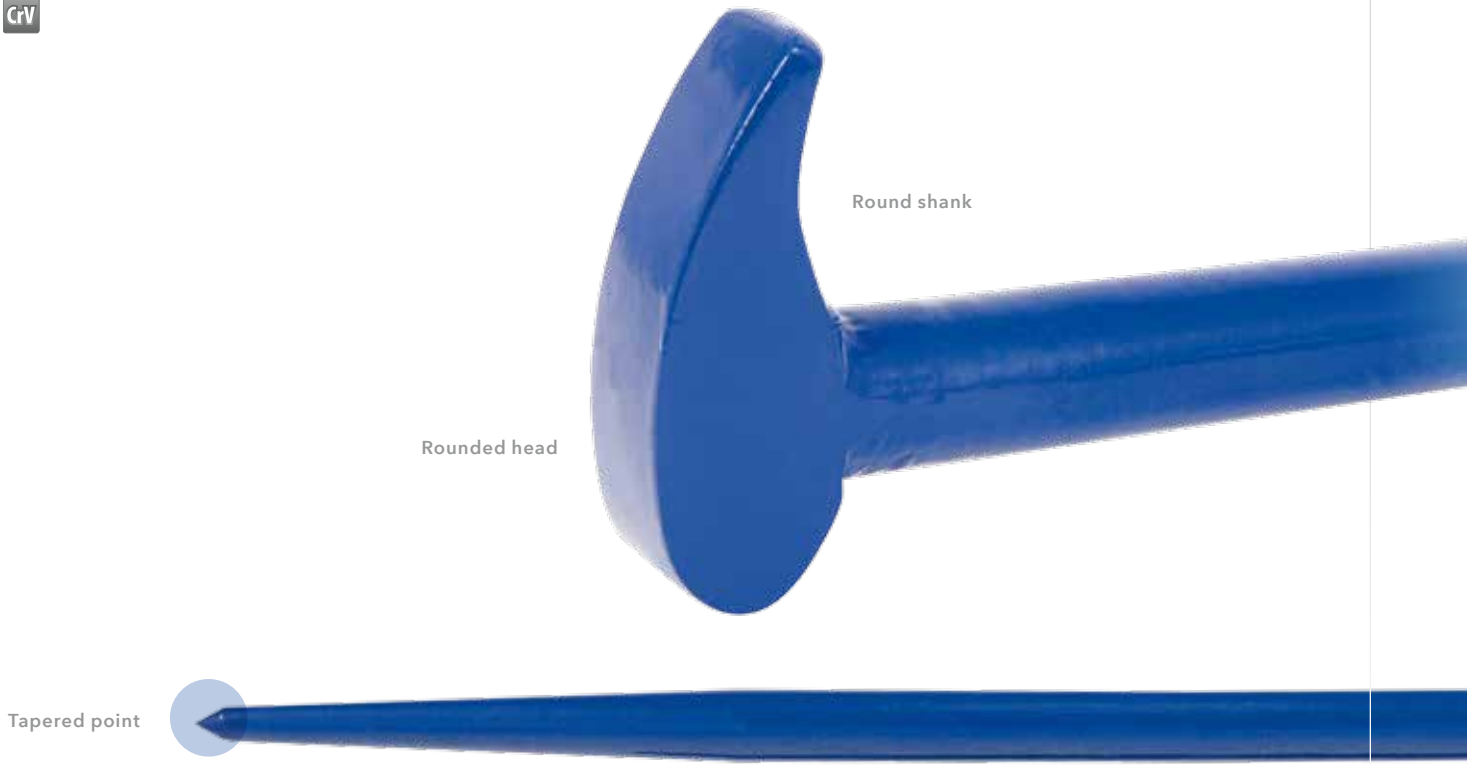

Round shank

Rounded head

Tapered point





# POWERCLAW™

Chrome Molybdenum  
claw and mechanism  
tested up to 5 times  
ANSI standard for fixed  
head pry bars!



779279  
Extendible Handle



Flush mount locking button minimizes head  
width for improved access



Chrome Molybdenum  
claw and mechanism  
tested up to 5 times  
ANSI standard for fixed  
head pry bars!



## PRY BARS - SUPER HEAVY DUTY



Indexible Pry Bars are fast becoming a "must have" tool in every mechanic's tool chest. The angle of the claw can be set and locked to provide the best possible leverage in any situation with just a single pry bar. JET takes this new technology to the next level with our exclusive Ratcheting Indexible Pry Bars. These unique tools provide all the benefits of Indexible Pry Bars PLUS the handle can be ratcheted back and forth. This allows the user to gain more leverage as the pried part is loosened without having to reposition the bar. Available only from JET!

### 3 PC POWERCLAW™ Ratcheting Indexible Pry Bar Set - Super Heavy Duty 779271/JRPB-3S

- Indexible claw locks in up to 8 positions for added torque
- Dual purpose lock button switches between indexed angle setting or ratcheting function
- Chrome Vanadium steel handle with Black Chrome finish for excellent corrosion resistance
- Set contains: **9, 12 and 15"**

### Ratcheting Indexible Pry Bars - Open Stock

PROD. NO.	MOD. NO.	Length	Contained in Set
779274	JRPB-9	<b>9"</b>	779271
779275	JRPB-12	<b>12"</b>	779271
779276	JRPB-15	<b>15"</b>	779271
779277	JRPB-24	<b>24"</b>	-
779279	JRPB-1830	<b>18 - 30"</b> (Extendible Handle)	



Unique ratcheting mechanism allows  
handle to be ratcheted back and  
forth to gain additional leverage in  
extremely limited spaces

### 2 PC POWERCLAW™ Indexible Pry Bar Set - Super Heavy Duty

779266/JIPB-2

- Chrome Vanadium steel handle with Black Chrome finish for excellent corrosion resistance
- Set Contents: 1 each **8", 16"**
- Traditional non-ratcheting style

### Indexible Pry Bars - Open Stock

PROD. NO.	MOD. NO.	Length	Contained in Set
779267	JIPB-8	<b>8"</b>	779266
779268	JIPB-16	<b>16"</b>	779266



Indexible claw locks into any of 10  
positions for improved leverage in  
confined spaces



# MASTER TOOL KITS







# 549 PIECE MASTER TOOL KIT

699704 / MTK-549

**Kit Count Product Description**

1	10" Bastard Cut Flat File
2	8" Smooth Cut Flat File
3	10" Smooth Cut Flat File
4	8" Bastard Half Round File
5	10" Bastard Half Round File
6	10" Bastard Cut Mill File
7	10" Bastard Cut Round File
8	1/16" JET-KUT B&G Premium M2 H.S.S. Jobber Drill Bit
9	5/64" JET-KUT B&G Premium M2 H.S.S. Jobber Drill Bit
10	3/32" JET-KUT B&G Premium M2 H.S.S. Jobber Drill Bit
11	7/64" JET-KUT B&G Premium M2 H.S.S. Jobber Drill Bit
12	1/8" JET-KUT B&G Premium M2 H.S.S. Jobber Drill Bit
13	9/64" JET-KUT B&G Premium M2 H.S.S. Jobber Drill Bit
14	5/32" JET-KUT B&G Premium M2 H.S.S. Jobber Drill Bit
15	11/64" JET-KUT B&G Premium M2 H.S.S. Jobber Drill Bit
16	3/16" JET-KUT B&G Premium M2 H.S.S. Jobber Drill Bit
17	13/64" JET-KUT B&G Premium M2 H.S.S. Jobber Drill Bit
18	7/32" JET-KUT B&G Premium M2 H.S.S. Jobber Drill Bit
19	15/64" JET-KUT B&G Premium M2 H.S.S. Jobber Drill Bit
20	1/4" JET-KUT B&G Premium M2 H.S.S. Jobber Drill Bit
21	17/64" JET-KUT B&G Premium M2 H.S.S. Jobber Drill Bit
22	9/32" JET-KUT B&G Premium M2 H.S.S. Jobber Drill Bit
23	19/64" JET-KUT B&G Premium M2 H.S.S. Jobber Drill Bit
24	5/16" JET-KUT B&G Premium M2 H.S.S. Jobber Drill Bit
25	21/64" JET-KUT B&G Premium M2 H.S.S. Jobber Drill Bit
26	11/32" JET-KUT B&G Premium M2 H.S.S. Jobber Drill Bit
27	23/64" JET-KUT B&G Premium M2 H.S.S. Jobber Drill Bit
28	3/8" JET-KUT B&G Premium M2 H.S.S. Jobber Drill Bit
29	25/64" JET-KUT B&G Premium M2 H.S.S. Jobber Drill Bit
30	13/32" JET-KUT B&G Premium M2 H.S.S. Jobber Drill Bit
31	27/64" JET-KUT B&G Premium M2 H.S.S. Jobber Drill Bit
32	7/16" JET-KUT B&G Premium M2 H.S.S. Jobber Drill Bit
33	29/64" JET-KUT B&G Premium M2 H.S.S. Jobber Drill Bit
34	15/32" JET-KUT B&G Premium M2 H.S.S. Jobber Drill Bit
35	31/64" JET-KUT B&G Premium M2 H.S.S. Jobber Drill Bit
36	1/2" JET-KUT B&G Premium M2 H.S.S. Jobber Drill Bit
37	Metal Box with Drill Index
38	1/4" Dr x 3/16" 6 Point Socket
39	1/4" Dr x 7/32" 6 Point Socket
40	1/4" Dr x 1/4" 6 Point Socket
41	1/4" Dr x 9/32" 6 Point Socket
42	1/4" Dr x 5/16" 6 Point Socket
43	1/4" Dr x 11/32" 6 Point Socket
44	1/4" Dr x 3/8" 6 Point Socket
45	1/4" Dr x 7/16" 6 Point Socket
46	1/4" Dr x 1/2" 6 Point Socket
47	1/4" Dr x 3/16" 6 Point Deep Socket
48	1/4" Dr x 7/32" 6 Point Deep Socket
49	1/4" Dr x 1/4" 6 Point Deep Socket
50	1/4" Dr x 9/32" 6 Point Deep Socket
51	1/4" Dr x 5/16" 6 Point Deep Socket
52	1/4" Dr x 11/32" 6 Point Deep Socket
53	1/4" Dr x 3/8" 6 Point Deep Socket
54	1/4" Dr x 7/16" 6 Point Deep Socket
55	1/4" Dr x 1/2" 6 Point Deep Socket
56	1/4" Dr x 4mm 6 Point Socket
57	1/4" Dr x 5mm 6 Point Socket
58	1/4" Dr x 6mm 6 Point Socket
59	1/4" Dr x 7mm 6 Point Socket
60	1/4" Dr x 8mm 6 Point Socket
61	1/4" Dr x 9mm 6 Point Socket
62	1/4" Dr x 10mm 6 Point Socket
63	1/4" Dr x 11mm 6 Point Socket
64	1/4" Dr x 12mm 6 Point Socket
65	1/4" Dr x 4mm 6 Point Deep Socket
66	1/4" Dr x 5mm 6 Point Deep Socket
67	1/4" Dr x 6mm 6 Point Deep Socket
68	1/4" Dr x 7mm 6 Point Deep Socket
69	1/4" Dr x 8mm 6 Point Deep Socket
70	1/4" Dr x 9mm 6 Point Deep Socket
71	1/4" Dr x 10mm 6 Point Deep Socket



842563

42"  
page 14

842513



Recommended tool boxes

842663

41"  
page 18

842613



**Kit Count Product Description**

72	1/4" Dr x 11mm 6 Point Deep Socket
73	1/4" Dr x 12mm 6 Point Deep Socket
74	2" Extension
75	Universal Joint
76	6" Spinner Handle
77	4" Extension
78	1/4" Ratchet Handle
79	Blow Mould Case
80	3/8" Dr x 3/8" 6 Point Socket
81	3/8" Dr x 7/16" 6 Point Socket
82	3/8" Dr x 1/2" 6 Point Socket
83	3/8" Dr x 9/16" 6 Point Socket
84	3/8" Dr x 5/8" 6 Point Socket
83	3/8" Dr x 9/16" 6 Point Socket
84	3/8" Dr x 5/8" 6 Point Socket
85	3/8" Dr x 11/16" 6 Point Socket
86	3/8" Dr x 3/4" 6 Point Socket
87	3/8" Dr x 3/8" 6 Point Deep Socket
88	3/8" Dr x 7/16 6 Point Deep Socket
89	3/8" Dr x 1/2" 6 Point Deep Socket
90	3/8" Dr x 9/16" 6 Point Deep Socket
91	3/8" Dr x 5/8" 6 Point Deep Socket
92	3/8" Dr x 11/16" 6 Point Deep Socket
93	3/8" Dr x 3/4" 6 Point Deep Socket
94	3/8" Dr x 13/16" 6 Point Deep Socket

**Kit Count Product Description**

95	3/8" Dr x 8mm 6 Point Socket
96	3/8" Dr x 9mm 6 Point Socket
97	3/8" Dr x 10mm 6 Point Socket
98	3/8" Dr x 11mm 6 Point Socket
99	3/8" Dr x 12mm 6 Point Socket
100	3/8" Dr x 13mm 6 Point Socket
101	3/8" Dr x 14mm 6 Point Socket
102	3/8" Dr x 15mm 6 Point Socket
103	3/8" Dr x 16mm 6 Point Socket
104	3/8" Dr x 17mm 6 Point Socket
105	3/8" Dr x 18mm 6 Point Socket
106	3/8" Dr x 19mm 6 Point Socket
107	3/8" Dr x 8mm 6 Point Deep Socket
108	3/8" Dr x 9mm 6 Point Deep Socket
107	3/8" Dr x 8mm 6 Point Deep Socket
108	3/8" Dr x 9mm 6 Point Deep Socket
109	3/8" Dr x 10mm 6 Point Deep Socket
110	3/8" Dr x 11mm 6 Point Deep Socket
111	3/8" Dr x 12mm 6 Point Deep Socket
112	3/8" Dr x 13mm 6 Point Deep Socket
113	3/8" Dr x 14mm 6 Point Deep Socket
114	3/8" Dr x 15mm 6 Point Deep Socket
115	3/8" Dr x 16mm 6 Point Deep Socket
116	3/8" Dr x 17mm 6 Point Deep Socket
117	3/8" Dr x 18mm 6 Point Deep Socket

Tool storage not included with kit, see tool storage options

Kit Count	Product Description
118	3/8" Dr x 19mm 6 Point Deep Socket
119	Flex Handle
120	3" Extension
121	6" Extension
122	Universal Joint
123	High Torque Ratchet
124	Blow Mould Case
125	1/2" Dr - 3/8" 6 Point Socket
126	1/2" Dr x 7/16" 6 Point Socket
127	1/2" Dr x 1/2" 6 Point Socket
128	1/2" Dr x 9/16" 6 Point Socket
129	1/2" Dr x 5/8" 6 Point Socket Wrench
130	1/2" Dr x 11/16" 6 Point Socket Wrench
131	1/2" Dr x 3/4" 6 Point Socket
132	1/2" Dr x 13/16" 6 Point Socket
133	1/2" Dr x 7/8" 6 Point Socket
134	1/2" Dr x 15/16" 6 Point Socket
135	1/2" Dr x 1" 6 Point Socket
136	1/2" Dr x 1-1/16" 6 Point Socket
137	1/2" Dr x 1-1/8" 6 Point Socket
138	1/2" Dr x 1-3/16" 6 Point Socket
139	1/2" Dr x 1-1/4" 6 Point Socket
140	1/2" Dr x 7/16" 6 Point Deep Socket
141	1/2" Dr x 1/2" 6 Point Deep Socket
142	1/2" Dr x 9/16" 6 Point Deep Socket
143	1/2" Dr x 5/8" 6 Point Deep Socket
144	1/2" Dr x 11/16" 6 Point Deep Socket
145	1/2" Dr x 3/4" 6 Point Deep Socket
146	1/2" Dr x 7/8" 6 Point Deep Socket
147	1/2" Dr x 10mm 6 Point Socket
148	1/2" Dr x 11mm 6 Point Socket
149	1/2" Dr x 12mm 6 Point Socket
150	1/2" Dr x 13mm 6 Point Socket
151	1/2" Dr x 14mm 6 Point Socket
152	1/2" Dr x 15mm 6 Point Socket
153	1/2" Dr x 16mm 6 Point Socket
154	1/2" Dr x 17mm 6 Point Socket
155	1/2" Dr x 18mm 6 Point Socket
156	1/2" Dr x 19mm 6 Point Socket
157	1/2" Dr x 21mm 6 Point Socket
158	1/2" Dr x 22mm 6 Point Socket
159	1/2" Dr x 23mm 6 Point Socket
160	1/2" Dr x 24mm 6 Point Socket
161	1/2" Dr x 27mm 6 Point Socket
162	1/2" Dr x 30mm 6 Point Socket
163	1/2" Dr x 32mm 6 Point Socket
164	1/2" Dr x 10mm 6 Point Deep Socket
165	1/2" Dr x 12mm 6 Point Deep Socket
166	1/2" Dr x 13mm 6 Point Deep Socket
167	1/2" Dr x 14mm 6 Point Deep Socket
168	1/2" Dr x 15mm 6 Point Deep Socket
169	1/2" Dr x 16mm 6 Point Deep Socket
170	1/2" Dr x 17mm 6 Point Deep Socket
171	1/2" Dr x 18mm 6 Point Deep Socket
172	1/2" Dr x 19mm 6 Point Deep Socket
173	1/2" Dr x 21mm 6 Point Deep Socket
174	2" Extension
175	5" Extension
176	10" Extension
177	Sliding T Handle
178	Universal Joint
179	High Torque Ratchet
180	Blow Mould Case
181	3/8" Dr x E4 Torx Socket
182	3/8" Dr x E5 Torx Socket
183	3/8" Dr x E6 Torx Socket
184	3/8" Dr x E7 Torx Socket
185	3/8" Dr x E8 Torx Socket
186	3/8" Dr x E10 Torx Socket
187	3/8" Dr x E11 Torx Socket
188	3/8" Dr x E12 Torx Socket
189	3/8" Dr x E14 Torx Socket
190	3/8" Dr x E16 Torx Socket
191	3/8" Dr x E18 Torx Socket
192	3/8" Dr x E20 Torx Socket

Kit Count	Product Description
193	Socket Clip
194	1/2" Dr x 10mm 12 Point Socket
195	1/2" Dr x 11mm 12 Point Socket
196	1/2" Dr x 12mm 12 Point Socket
197	1/2" Dr x 13mm 12 Point Socket
198	1/2" Dr x 14mm 12 Point Socket
199	1/2" Dr x 15mm 12 Point Socket
200	1/2" Dr x 16mm 12 Point Socket
201	1/2" Dr x 17mm 12 Point Socket
202	1/2" Dr x 18mm 12 Point Socket
203	1/2" Dr x 19mm 12 Point Socket
204	1/2" Dr x 20mm 12 Point Socket
205	1/2" Dr x 21mm 12 Point Socket
206	1/2" Dr x 22mm 12 Point Socket
207	1/2" Dr x 24mm 12 Point Socket
208	Socket Clip
209	3/8" Dr x 1/8" Hex Key Socket
210	3/8" Dr x 5/32" Hex Key Socket
211	3/8" Dr x 3/16" Hex Key Socket
212	3/8" Dr x 7/32" Hex Key Socket
213	3/8" Dr x 1/4" Hex Key Socket
214	3/8" Dr x 5/16" Hex Key Socket
215	3/8" Dr x 3/8" Hex Key Socket
216	1/2" Dr x 1/2" Hex Key Socket
217	1/2" Dr x 9/16" Hex Key Socket
218	1/2" Dr x 5/8" Hex Key Socket
219	Socket Clip
220	3/8" Dr x 3mm Hex Key Socket
221	3/8" Dr x 4mm Hex Key Socket
222	3/8" Dr x 5mm Hex Key Socket
223	3/8" Dr x 6mm Hex Key Socket
224	3/8" Dr x 7mm Hex Key Socket
225	3/8" Dr x 8mm Hex Key Socket
226	3/8" Dr x 10mm Hex Key Socket
227	1/2" Dr x 12mm Hex Key Socket
228	1/2" Dr x 14mm Hex Key Socket
229	1/2" Dr x 16mm Hex Key Socket
230	Socket Clip
231	1/8" Extra Long Hex Bit Socket
232	5/32" Extra Long Hex Bit Socket
233	3/16" Extra Long Hex Bit Socket
234	7/32" Extra Long Hex Bit Socket
235	1/4" Extra Long Hex Bit Socket
236	5/16" Extra Long Hex Bit Socket
237	3/8" Extra Long Hex Bit Socket
238	Socket Clip
239	4mm Extra Long Hex Bit Socket
240	5mm Extra Long Hex Bit Socket
241	6mm Extra Long Hex Bit Socket
242	7mm Extra Long Hex Bit Socket
243	8mm Extra Long Hex Bit Socket
244	9mm Extra Long Hex Bit Socket
245	10mm Extra Long Hex Bit Socket
246	Socket Clip
247	1/4" Dr x T10 Torx Bit Socket
248	1/4" Dr x T15 Torx Bit Socket
249	1/4" Dr x T20 Torx Bit Socket
250	1/4" Dr x T25 Torx Bit Socket
251	1/4" Dr x T27 Torx Bit Socket
252	1/4" Dr x T30 Torx Bit Socket
253	3/8" Dr x T40 Torx Bit Socket
254	3/8" Dr x T45 Torx Bit Socket
255	3/8" Dr x T47 Torx Bit Socket
256	3/8" Dr x T50 Torx Bit Socket
257	3/8" Dr x T55 Torx Bit Socket
258	Socket Clip
259	1/4" Dr - 6" Spinner Handle
260	3/8" Dr - 16" Speeder Handle
261	3/8" Dr - 5/8" Spark Plug Socket
262	3/8" Dr - 13/16" Spark Plug Socket
263	1/2" Dr - 5" Flex Handle

Kit Count	Product Description
264	1/2" Dr - 16-1/2" Speeder Handle
265	1/2" Dr - 15" Extension Bar
266	1/2" Dr - 18" Extension Bar
267	1/2" Dr - 24" Extension Bar
268	1/2" Dr - 30" Extension Bar
269	3/8" Dr - 1-3/4" 2 Way Extension
270	3/8" Dr - 3" 2 Way Extension
271	3/8" Dr - 6" 2 Way Extension
272	3/8" Dr - 10" 2 Way Extension
273	3/8" Long Combination Wrench
274	7/16" Long Combination Wrench
275	1/2" Long Combination Wrench
276	9/16" Long Combination Wrench
277	5/8" Long Combination Wrench
278	11/16" Long Combination Wrench
279	3/4" Long Combination Wrench
280	13/16" Long Combination Wrench
281	7/8" Long Combination Wrench
282	15/16" Long Combination Wrench
283	1" Long Combination Wrench
284	1-1/16" Long Combination Wrench
285	1-1/8" Long Combination Wrench
286	1-1/4" Long Combination Wrench
287	Terylene Pouch
288	3/8" Stubby Combination Wrench
289	7/16" Stubby Combination Wrench
290	1/2" Stubby Combination Wrench
291	9/16" Stubby Combination Wrench
292	5/8" Stubby Combination Wrench
293	11/16" Stubby Combination Wrench
294	3/4" Stubby Combination Wrench
295	Plastic Rack
296	7mm Long Combination Wrench
297	8mm Long Combination Wrench
298	9mm Long Combination Wrench
299	10mm Long Combination Wrench
300	11mm Long Combination Wrench
301	12mm Long Combination Wrench
302	13mm Long Combination Wrench
303	14mm Long Combination Wrench
300	11mm Long Combination Wrench
301	12mm Long Combination Wrench
302	13mm Long Combination Wrench
303	14mm Long Combination Wrench
304	15mm Long Combination Wrench
305	16mm Long Combination Wrench
306	17mm Long Combination Wrench
307	18mm Long Combination Wrench
308	19mm Long Combination Wrench
309	21mm Long Combination Wrench
310	22mm Long Combination Wrench
311	24mm Long Combination Wrench
312	Terylene Pouch
313	10mm Stubby Combination Wrench
314	11mm Stubby Combination Wrench
315	12mm Stubby Combination Wrench
316	13mm Stubby Combination Wrench
317	14mm Stubby Combination Wrench
318	17mm Stubby Combination Wrench
319	19mm Stubby Combination Wrench
320	Plastic Rack
321	1/4" Ratcheting Combination Wrench
322	5/16" Ratcheting Combination Wrench
323	3/8" Ratcheting Combination Wrench
324	7/16" Ratcheting Combination Wrench
325	1/2" Ratcheting Combination Wrench
326	9/16" Ratcheting Combination Wrench
327	5/8" Ratcheting Combination Wrench
328	11/16" Ratcheting Combination Wrench
329	3/4" Ratcheting Combination Wrench
330	13/16" Ratcheting Combination Wrench
331	7/8" Ratcheting Combination Wrench
332	15/16" Ratcheting Combination Wrench



# 549 PIECE MASTER TOOL KIT

## 699704 / MTK-549

### Kit Count Product Description

333	1" Ratcheting Combination Wrench
334	Plastic Rack
335	8mm Ratcheting Combination Wrench
336	9mm Ratcheting Combination Wrench
337	10mm Ratcheting Combination Wrench
338	11mm Ratcheting Combination Wrench
339	12mm Ratcheting Combination Wrench
340	13mm Ratcheting Combination Wrench
341	14mm Ratcheting Combination Wrench
342	15mm Ratcheting Combination Wrench
343	16mm Ratcheting Combination Wrench
344	17mm Ratcheting Combination Wrench
345	18mm Ratcheting Combination Wrench
346	19mm Ratcheting Combination Wrench
347	Plastic Rack
348	18" Aluminum Pipe Wrench
349	8" Professional Adjustable Wrench
350	12" Professional Adjustable Wrench
351	3/8" Dr Torque Wrench
352	1/2" Dr Torque Wrench
353	3/8" x 7/16" Flare Nut Wrench
354	1/2" x 9/16" Flare Nut Wrench
355	5/8" x 11/16" Flare Nut Wrench
356	10mm x 11mm Flare Nut Wrench
357	12mm x 13mm Flare Nut Wrench
358	15mm x 17mm Flare Nut Wrench
359	Phillips: #2 x 1-1/2" Jumbo Handle Screwdriver
360	Phillips: #1 x 3" Jumbo Handle Screwdriver
361	Phillips: #2 x 4" Jumbo Handle Screwdriver
362	Phillips: #3 x 6" Jumbo Handle Screwdriver
363	Square: #2 x 1-1/2" Jumbo Handle Screwdriver
364	Square: #1 x 4" Jumbo Handle Screwdriver
365	Square: #2 x 5" Jumbo Handle Screwdriver
366	Square: #3 x 6" Jumbo Handle Screwdriver
367	Slot Square Shaft: 1/4 x 1-1/2" Jumbo Handle Screwdriver
368	Slot Square Shaft: 1/4 x 4" Jumbo Handle Screwdriver
369	Slot Square Shaft: 5/16 x 6" Jumbo Handle Screwdriver
370	Slot Square Shaft: 3/8 x 10" Jumbo Handle Screwdriver
371	Slot Round Shaft: 3/16 x 3" Jumbo Handle Screwdriver
372	Slot Round Shaft: 3/16 x 6" Jumbo Handle Screwdriver
373	Blow Mould Case
374	2.0 Slot Precision Screwdriver
375	3.0 Slot Precision Screwdriver
376	4.0 Slot Precision Screwdriver
377	#00 Phillips Precision Screwdriver
378	#0 Phillips Precision Screwdriver
379	#1 Phillips Precision Screwdriver
380	Plastic Case
381	T5 Torx Precision Screwdriver
382	T6 Torx Precision Screwdriver
383	T7 Torx Precision Screwdriver
384	T8 Torx Precision Screwdriver
385	T9 Torx Precision Screwdriver
386	T10 Torx Precision Screwdriver
387	Plastic Case
388	Ratcheting Screwdriver Handle
389	1/8" Slot Bit for Ratcheting Screwdriver
390	#0 Phillips Bit for Ratcheting Screwdriver
391	3/16" Slot Bit for Ratcheting Screwdriver
392	#1 Phillips Bit for Ratcheting Screwdriver
393	1/4" Slot Bit for Ratcheting Screwdriver
394	#2 Phillips Bit for Ratcheting Screwdriver
395	5/16" Slot Bit for Ratcheting Screwdriver
396	#3 Phillips Bit for Ratcheting Screwdriver
397	#1 Square Bit for Ratcheting Screwdriver
398	#2 Square Bit for Ratcheting Screwdriver
399	T10 Torx Bit for Ratcheting Screwdriver
400	T15 Torx Bit for Ratcheting Screwdriver
401	T20 Torx Bit for Ratcheting Screwdriver
402	T25 Torx Bit for Ratcheting Screwdriver
403	1/8" Hex Bit for Ratcheting Screwdriver
404	3/16" Hex Bit for Ratcheting Screwdriver
405	Nut Driver for Ratcheting Screwdriver

### Kit Count Product Description

406	Nut Driver for Ratcheting Screwdriver
407	Nut Driver for Ratcheting Screwdriver
408	5/16" Slotted Bit for Impact Driver
409	3/8" Slotted Bit for Impact Driver
410	#2 Phillips Bit for Impact Driver
411	#3 Phillips Bit for Impact Driver
412	Driver for Impact Driver
413	Adapter for Impact Driver
414	Plastic Case
415	3/16" Jumbo Handle Nut Driver
416	1/4" Jumbo Handle Nut Driver
417	5/16" Jumbo Handle Nut Driver
418	11/32" Jumbo Handle Nut Driver
419	3/8" Jumbo Handle Nut Driver
420	7/16" Jumbo Handle Nut Driver
421	1/2" Jumbo Handle Nut Driver
422	6" Slip Joint Pliers - Standard Duty
423	8" Slip Joint Pliers - Standard Duty
424	9-1/2" Groove Joint Plier - Chrome Vanadium
425	12" Groove Joint Plier - Chrome Vanadium
426	5" Curved Jaw Locking Pliers
427	4" Curved Jaw Locking Pliers
428	10" Curved Jaw Locking Pliers
429	6" Long Nose Locking Pliers
430	9" Long Nose Locking Pliers
431	8" Linesman's Pliers - Chrome Vanadium
432	8" Long Nose Pliers - Chrome Vanadium
433	1" Long Nose Pliers
434	7-1/2" Diagonal Cutter - Chrome Vanadium
435	6-1/2" Bent Nose Pliers
436	8" Bent Nose Pliers
437	11" C-Clamp and Pads
438	Wire Stripper
439	Straight Cut Aviation Metal Snips
440	Telescopic Tube Cutter
441	Mini Tubing Cutter
442	Screw Feed Tubing Cutter for Flaring Tool Kit
443	Flaring Bar for Flaring Tool Kit
444	Yoke for Flaring Tool Kit
445	3/16" Flaring Insert for Flaring Tool Kit
446	1/4" Flaring Insert for Flaring Tool Kit
447	5/16" Flaring Insert for Flaring Tool Kit
448	3/8" Flaring Insert for Flaring Tool Kit
449	7/16" Flaring Insert for Flaring Tool Kit
450	1/2" Flaring Insert for Flaring Tool Kit
451	5/8" Flaring Insert for Flaring Tool Kit
452	Blow Mould Case
453	8oz Ball Pein Fibreglass Hammer
454	16oz Ball Pein Fibreglass Hammer
455	24oz Ball Pein Fibreglass Hammer
456	32oz Ball Pein Fibreglass Hammer
457	40oz Ball Pein Fibreglass Hammer
458	2 lb Dead Blow Hammer
459	3 lb Dead Blow Hammer
460	2-1/4 lb Soft Face Dead Blow Hammer
461	3 lb Drilling Hammer
462	3" 2/3 Jaw Gear Puller
463	0.05" Long Arm Ball Nose Hex Key
464	1/16" Long Arm Ball Nose Hex Key
465	5/64" Long Arm Ball Nose Hex Key
466	3/32" Long Arm Ball Nose Hex Key
467	7/64" Long Arm Ball Nose Hex Key
468	1/8" Long Arm Ball Nose Hex Key
469	9/64" Long Arm Ball Nose Hex Key
470	5/32" Long Arm Ball Nose Hex Key
471	3/16" Long Arm Ball Nose Hex Key
472	7/32" Long Arm Ball Nose Hex Key
473	1/4" Long Arm Ball Nose Hex Key
474	5/16" Long Arm Ball Nose Hex Key
475	3/8" Long Arm Ball Nose Hex Key
476	1.5mm Long Arm Ball Nose Hex Key
477	2.0mm Long Arm Ball Nose Hex Key
478	2.5mm Long Arm Ball Nose Hex Key

### Kit Count Product Description

479	3.0mm Long Arm Ball Nose Hex Key
480	4.0mm Long Arm Ball Nose Hex Key
481	5.0mm Long Arm Ball Nose Hex Key
482	6.0mm Long Arm Ball Nose Hex Key
483	8.0mm Long Arm Ball Nose Hex Key
484	10mm Long Arm Ball Nose Hex Key
485	Plastic Rack
486	T8 Torx Key
487	T10 Torx Key
488	T15 Torx Key
489	T20 Torx Key
490	T25 Torx Key
491	T27 Torx Key
492	T30 Torx Key
493	T40 Torx Key
494	12" Hacksaw Frame
495	1/16" Pin Punch
496	3/32" Pin Punch
497	1/8" Pin Punch
498	5/32" Pin Punch
499	3/16" Pin Punch
500	1/4" Pin Punch
501	5/16" Pin Punch
502	1/16" Solid Punch
503	1/8" Solid Punch
504	3/16" Solid Punch
505	1/4" Solid Punch
506	5/16" Solid Punch
507	5/32" Solid Punch
508	1/4" Cold Chisel
509	5/16" Cold Chisel
510	1/2" Cold Chisel
511	5/8" Cold Chisel
512	3/4" Cold Chisel
513	7/8" Cold Chisel
514	3/8" Cold Chisel
515	5/64" Centre Punch
516	5/32" Centre Punch
517	1/4" Centre Punch
518	Automatic Centre Punch
519	Terylene Pouch
520	3/32" Roll Pin Punch
521	1/8" Roll Pin Pinch
522	5/32" Roll Pin Punch
523	3/16" Roll Pin Punch
524	1/4" Roll Pin Punch
525	5/16" Roll Pin Punch
526	Terylene Pouch
527	25ft Tape Measure
528	8" Mechanic's Pry Bar
529	12" Mechanic's Pry Bar
530	18" Mechanic's Pry Bar
531	24" Mechanic's Pry Bar
532	6" Straight Pick
533	6" 90 Pick
534	6" Compound Hook
535	6" Bent Hook
536	8-1/2" Scraper
537	10" Scraper
538	12" Scraper
539	9" Cotter Key Puller
540	7-1/2" Radiator Hose Hook
541	1-1/4" Chisel Scraper
542	1-1/4" Bent Chisel Scraper
543	2" Chisel Scraper
544	Stubby Chisel Scraper
545	1/4"-5/16" Screw Extractor
546	3/8" Screw Extractor
547	7/16" Screw Extractor
548	1/2"-9/16" Screw Extractor
549	5/8" Screw Extractor



# 306 PIECE INTERMEDIATE TOOL KIT

699703 / MIK-306



Recommended tool boxes



**42"**  
page 14

842513



**41"**  
page 18

842613



**27"**  
page 13

842503



**27"**  
page 16

842604

Kit Count	Product Description
1	1/16" JET-KUT Black Oxide H.S.S. Jobber Drill Bit
2	5/64" JET-KUT Black Oxide H.S.S. Jobber Drill Bit
3	3/32" JET-KUT Black Oxide H.S.S. Jobber Drill Bit
4	7/64" JET-KUT Black Oxide H.S.S. Jobber Drill Bit
5	1/8" JET-KUT Black Oxide H.S.S. Jobber Drill Bit
6	9/64" JET-KUT Black Oxide H.S.S. Jobber Drill Bit
7	5/32" JET-KUT Black Oxide H.S.S. Jobber Drill Bit
8	11/64" JET-KUT Black Oxide H.S.S. Jobber Drill Bit
9	3/16" JET-KUT Black Oxide H.S.S. Jobber Drill Bit
10	13/64" JET-KUT Black Oxide H.S.S. Jobber Drill Bit
11	7/32" JET-KUT Black Oxide H.S.S. Jobber Drill Bit
12	15/64" JET-KUT Black Oxide H.S.S. Jobber Drill Bit
13	1/4" JET-KUT Black Oxide H.S.S. Jobber Drill Bit
14	17/64" JET-KUT Black Oxide H.S.S. Jobber Drill Bit
15	9/32" JET-KUT Black Oxide H.S.S. Jobber Drill Bit
16	19/64" JET-KUT Black Oxide H.S.S. Jobber Drill Bit
17	5/16" JET-KUT Black Oxide H.S.S. Jobber Drill Bit
18	21/64" JET-KUT Black Oxide H.S.S. Jobber Drill Bit
19	11/32" JET-KUT Black Oxide H.S.S. Jobber Drill Bit
20	23/64" JET-KUT Black Oxide H.S.S. Jobber Drill Bit
21	3/8" JET-KUT Black Oxide H.S.S. Jobber Drill Bit
22	25/64" JET-KUT Black Oxide H.S.S. Jobber Drill Bit
23	13/32" JET-KUT Black Oxide H.S.S. Jobber Drill Bit
24	27/64" JET-KUT Black Oxide H.S.S. Jobber Drill Bit
25	7/16" JET-KUT Black Oxide H.S.S. Jobber Drill Bit
26	29/64" JET-KUT Black Oxide H.S.S. Jobber Drill Bit
27	15/32" JET-KUT Black Oxide H.S.S. Jobber Drill Bit
28	31/64" JET-KUT Black Oxide H.S.S. Jobber Drill Bit

Kit Count	Product Description
29	1/2" JET-KUT Black Oxide H.S.S. Jobber Drill Bit
30	Metal Box with Drill Index
31	1/4" Dr x 3/16" 6 Point Socket
32	1/4" Dr x 7/32" 6 Point Socket
33	1/4" Dr x 1/4" 6 Point Socket
34	1/4" Dr x 9/32" 6 Point Socket
35	1/4" Dr x 5/16" 6 Point Socket
36	1/4" Dr x 11/32" 6 Point Socket
37	1/4" Dr x 3/8" 6 Point Socket
38	1/4" Dr x 7/16" 6 Point Socket
39	1/4" Dr x 1/2" 6 Point Socket
40	1/4" Dr x 3/16" 6 Point Deep Socket
41	1/4" Dr x 7/32" 6 Point Deep Socket
42	1/4" Dr x 1/4" 6 Point Deep Socket
43	1/4" Dr x 9/32" 6 Point Deep Socket
44	1/4" Dr x 5/16" 6 Point Deep Socket
45	1/4" Dr x 11/32" 6 Point Deep Socket
46	1/4" Dr x 3/8" 6 Point Deep Socket
46	1/4" Dr x 3/8" 6 Point Deep Socket
47	1/4" Dr x 7/16" 6 Point Deep Socket
48	1/4" Dr x 11/32" 6 Point Deep Socket
49	1/4" Dr x 4mm 6 Point Socket
50	1/4" Dr x 5mm 6 Point Socket
51	1/4" Dr x 6mm 6 Point Socket
52	1/4" Dr x 7mm 6 Point Socket
53	1/4" Dr x 8mm 6 Point Socket
54	1/4" Dr x 9mm 6 Point Socket
55	1/4" Dr x 10mm 6 Point Socket

Kit Count	Product Description
56	1/4" Dr x 11mm 6 Point Socket
57	1/4" Dr x 12mm 6 Point Socket
58	1/4" Dr x 4mm 6 Point Deep Socket
59	1/4" Dr x 5mm 6 Point Deep Socket
60	1/4" Dr x 6mm 6 Point Deep Socket
61	1/4" Dr x 7mm 6 Point Deep Socket
62	1/4" Dr x 8mm 6 Point Deep Socket
63	1/4" Dr x 9mm 6 Point Deep Socket
64	1/4" Dr x 10mm 6 Point Deep Socket
65	1/4" Dr x 11mm 6 Point Deep Socket
66	1/4" Dr x 12mm 6 Point Deep Socket
67	2" Extension
68	Universal Joint
69	6" Spinner Handle
70	4" Extension
71	1/4" Ratchet Handle
72	Blow Mould Case
73	3/8" Dr x 3/8" 6 Point Socket
74	3/8" Dr x 7/16" 6 Point Socket
75	3/8" Dr x 1/2" 6 Point Socket
76	3/8" Dr x 3/8" 6 Point Deep Socket
77	3/8" Dr x 5/8" 6 Point Socket
78	3/8" Dr x 11/16" 6 Point Socket
79	3/8" Dr x 3/4" 6 Point Socket
80	3/8" Dr x 3/8" 6 Point Deep Socket
81	3/8" Dr x 7/16" 6 Point Deep Socket
82	3/8" Dr x 1/2" 6 Point Deep Socket
83	3/8" Dr x 9/16" 6 Point Deep Socket

Tool storage not included with kit, see tool storage options



## 306 PIECE INTERMEDIATE TOOL KIT

### 699703 / MIK-306

#### Kit Count Product Description

84	3/8" Dr x 5/8" 6 Point Deep Socket
85	3/8" Dr x 11/16" 6 Point Deep Socket
86	3/8" Dr x 3/4" 6 Point Deep Socket
87	3/8" Dr x 13/16" 6 Point Deep Socket
88	3/8" Dr x 8mm 6 Point Socket
89	3/8" Dr x 9mm 6 Point Socket
90	3/8" Dr x 10mm 6 Point Socket
91	3/8" Dr x 11mm 6 Point Socket
92	3/8" Dr x 12mm 6 Point Socket
93	3/8" Dr x 13mm 6 Point Socket
94	3/8" Dr x 14mm 6 Point Socket
95	3/8" Dr x 15mm 6 Point Socket
96	3/8" Dr x 16mm 6 Point Socket
97	3/8" Dr x 17mm 6 Point Socket
98	3/8" Dr x 18mm 6 Point Socket
99	3/8" Dr x 19mm 6 Point Socket
100	3/8" Dr x 8mm 6 Point Deep Socket
101	3/8" Dr x 9mm 6 Point Deep Socket
102	3/8" Dr x 10mm 6 Point Deep Socket
103	3/8" Dr x 11mm 6 Point Deep Socket
104	3/8" Dr x 12mm 6 Point Deep Socket
105	3/8" Dr x 13mm 6 Point Deep Socket
106	3/8" Dr x 14mm 6 Point Deep Socket
107	3/8" Dr x 15mm 6 Point Deep Socket
108	3/8" Dr x 16mm 6 Point Deep Socket
109	3/8" Dr x 17mm 6 Point Deep Socket
110	3/8" Dr x 18mm 6 Point Deep Socket
111	3/8" Dr x 19mm 6 Point Deep Socket
112	Flex Handle
113	3" Extension
114	6" Extension
115	Universal Joint
116	High Torque Ratchet
117	Blow Mould Case
118	1/8" Hex Bit Socket
119	5/32" Hex Bit Socket
120	3/16" Hex Bit Socket
121	7/32" Hex Bit Socket
122	1/4" Hex Bit Socket
123	5/16" Hex Bit Socket
124	3/8" Hex Bit Socket
125	Socket Clip
126	3/8" Dr x 3mm Hex Bit Socket
127	3/8" Dr x 4mm Hex Bit Socket
128	3/8" Dr x 5mm Hex Bit Socket
129	3/8" Dr x 6mm Hex Bit Socket
130	3/8" Dr x 7mm Hex Bit Socket
131	3/8" Dr x 8mm Hex Bit Socket
132	3/8" Dr x 10mm Hex Bit Socket
133	Socket Clip
134	1/4" Dr x T10 Tamperproof Torx Bit Socket
135	1/4" Dr x T15 Tamperproof Torx Bit Socket
136	1/4" Dr x T20 Tamperproof Torx Bit Socket
137	1/4" Dr x T25 Tamperproof Torx Bit Socket
138	1/4" Dr x T27 Tamperproof Torx Bit Socket
139	1/4" Dr x T30 Tamperproof Torx Bit Socket
140	3/8" Dr x T40 Tamperproof Torx Bit Socket
141	3/8" Dr x T45 Tamperproof Torx Bit Socket
142	3/8" Dr x T50 Tamperproof Torx Bit Socket
143	3/8" Dr x T55 Tamperproof Torx Bit Socket
144	Socket Clip
145	6" Flex Handle
146	3/8" Dr - 5/8" Spark Plug Socket
147	3/8" Dr - 13/16" Spark Plug Socket
148	3/8" Long Combination Wrench
149	7/16" Long Combination Wrench
150	1/2" Long Combination Wrench
151	9/16" Long Combination Wrench
152	5/8" Long Combination Wrench
153	11/16" Long Combination Wrench
154	3/4" Long Combination Wrench
155	13/16" Long Combination Wrench
156	7/8" Long Combination Wrench

#### Kit Count Product Description

157	15/16" Long Combination Wrench
158	1" Long Combination Wrench
159	1-1/16" Long Combination Wrench
160	1-1/8" Long Combination Wrench
161	1-1/4" Long Combination Wrench
162	Terylene Pouch
163	7mm Long Combination Wrench
164	8mm Long Combination Wrench
165	9mm Long Combination Wrench
166	10mm Long Combination Wrench
167	11mm Long Combination Wrench
168	12mm Long Combination Wrench
169	13mm Long Combination Wrench
170	14mm Long Combination Wrench
171	15mm Long Combination Wrench
172	16mm Long Combination Wrench
173	17mm Long Combination Wrench
174	18mm Long Combination Wrench
175	19mm Long Combination Wrench
176	21mm Long Combination Wrench
177	22mm Long Combination Wrench
178	24mm Long Combination Wrench
179	Terylene Pouch
180	8mm Ratcheting Combination Wrench
181	10mm Ratcheting Combination Wrench
182	12mm Ratcheting Combination Wrench
183	13mm Ratcheting Combination Wrench
184	14mm Ratcheting Combination Wrench
185	15mm Ratcheting Combination Wrench
186	18mm Ratcheting Combination Wrench
187	Plastic Rack
188	5/16" Ratcheting Combination Wrench
189	3/8" Ratcheting Combination Wrench
190	7/16" Ratcheting Combination Wrench
191	1/2" Ratcheting Combination Wrench
192	9/16" Ratcheting Combination Wrench
193	5/8" Ratcheting Combination Wrench
194	11/16" Ratcheting Combination Wrench
195	3/4" Ratcheting Combination Wrench
196	Plastic Rack
197	10" Professional Adjustable Wrench
198	T10 x 4" Torx Mechanic's Screwdriver
199	T15 x 4" Torx Mechanic's Screwdriver
200	T20 x 4" Torx Mechanic's Screwdriver
201	T25 x 4" Torx Mechanic's Screwdriver
202	T27 x 4" Torx Mechanic's Screwdriver
203	T30 x 4" Torx Mechanic's Screwdriver
204	Slot: 1/4 x 1-1/2" Mechanic's Screwdriver
205	Slot: 1/4 x 4" Mechanic's Screwdriver
206	Slot: 5/16 x 6" Mechanic's Screwdriver
207	Slot: 3/8 x 10" Mechanic's Screwdriver
208	Phillips: #1 x 3" Mechanic's Screwdriver
209	Phillips: #2 x 1-1/2" Mechanic's Screwdriver
210	Phillips: #2 x 4" Mechanic's Screwdriver
211	Blow Mould Case
212	2.0 Slot Precision Screwdriver
213	3.0 Slot Precision Screwdriver
214	4.0 Slot Precision Screwdriver
215	#00 Phillips Precision Screwdriver
216	#0 Phillips Precision Screwdriver
217	#1 Phillips Precision Screwdriver
218	Plastic Case
219	T5 Torx Precision Screwdriver
220	T6 Torx Precision Screwdriver
221	T7 Torx Precision Screwdriver
222	T8 Torx Precision Screwdriver
223	T9 Torx Precision Screwdriver
224	T10 Torx Precision Screwdriver
225	Plastic Case
226	Ratcheting Screwdriver Handle
227	1/8" Slot Bit for Ratcheting Screwdriver
228	#0 Phillips Bit for Ratcheting Screwdriver
229	3/16" Slot Bit for Ratcheting Screwdriver
230	#1 Phillips Bit for Ratcheting Screwdriver
231	1/4" Slot Bit for Ratcheting Screwdriver

#### Kit Count Product Description

232	#2 Phillips Bit for Ratcheting Screwdriver
233	5/16" Slot Bit for Ratcheting Screwdriver
234	#3 Phillips Bit for Ratcheting Screwdriver
235	#1 Square Bit for Ratcheting Screwdriver
236	#2 Square Bit for Ratcheting Screwdriver
237	T10 Torx Bit for Ratcheting Screwdriver
238	T15 Torx Bit for Ratcheting Screwdriver
239	T20 Torx Bit for Ratcheting Screwdriver
240	T25 Torx Bit for Ratcheting Screwdriver
241	1/8" Hex Bit for Ratcheting Screwdriver
242	3/16" Hex Bit for Ratcheting Screwdriver
243	1/4" Nut Driver for Ratcheting Screwdriver
244	5/16" Nut Driver for Ratcheting Screwdriver
245	7/16" Nut Driver for Ratcheting Screwdriver
246	8" Slip Joint Pliers
247	6-1/2" Long Nose Pliers
248	6-1/2" Diagonal Cutter
249	9-1/2" Groove Joint Pliers
250	10" Curved Jaw Locking Pliers
251	9" Multifunction Wire Stripper
252	Straight Cut Aviation Metal Snips
253	Telescopic Tube Cutter
254	1lb Rubber Mallet
255	1.5mm Short Arm Hex Key
256	2.0mm Short Arm Hex Key
257	2.5mm Short Arm Hex Key
258	3.0mm Short Arm Hex Key
259	4.0mm Short Arm Hex Key
260	4.5mm Short Arm Hex Key
261	5.0mm Short Arm Hex Key
262	5.5mm Short Arm Hex Key
263	6.0mm Short Arm Hex Key
264	7.0mm Short Arm Hex Key
265	8.0mm Short Arm Hex Key
266	9.0mm Short Arm Hex Key
267	10.0mm Short Arm Hex Key
268	1/16" Long Arm Hex Key
269	5/64" Long Arm Hex Key
270	3/32" Long Arm Hex Key
271	7/64" Long Arm Hex Key
272	1/8" Long Arm Hex Key
273	9/64" Long Arm Hex Key
274	5/32" Long Arm Hex Key
275	3/16" Long Arm Hex Key
276	7/32" Long Arm Hex Key
277	1/4" Long Arm Hex Key
278	5/16" Long Arm Hex Key
279	3/8" Long Arm Hex Key
280	Plastic Rack
281	1/8" Pin Punch
282	3/16" Pin Punch
283	1/4" Pin Punch
284	3/16" Solid Punch
285	1/2" Cold Chisel
286	5/8" Cold Chisel
287	3/4" Cold Chisel
288	5/32" Centre Punch
289	Terylene Pouch
290	16ft Tape Measure
291	8" Mechanic's Pry Bar
292	12" Mechanic's Pry Bar
293	18" Mechanic's Pry Bar
294	24" Mechanic's Pry Bar
295	1" Short Scraper
296	Parts Cleaning Brush
297	6-12 Volt Circuit Tester
298	Long Telescoping Magnet
299	Mechanic's Stethoscope
300	1/8" - 1/4" Screw Extractor
301	1/4" - 5/16" Screw Extractor
302	5/16" - 7/16" Screw Extractor
303	7/16" - 9/16" Screw Extractor
304	9/16" - 3/4" Screw Extractor
305	Tie Rod End Puller
306	4-Battery Post and Terminal Clean

211 PIECE MECHANIC'S STARTER TOOL KIT  
699702 / STK-211



842652  
Included with kit







## 211 PIECE MECHANIC'S STARTER TOOL KIT

### 699702 / STK-211

#### Kit Count Product Description

1	1/4" Dr x 3/16" 6 Point Socket
2	1/4" Dr x 7/32" 6 Point Socket
3	1/4" Dr x 1/4" 6 Point Socket
4	1/4" Dr x 9/32" 6 Point Socket
5	1/4" Dr x 5/16" 6 Point Socket
6	1/4" Dr x 11/32" 6 Point Socket
7	1/4" Dr x 3/8" 6 Point Socket
8	1/4" Dr x 7/16" 6 Point Socket
9	1/4" Dr x 1/2" 6 Point Socket
10	1/4" Dr x 3/16" 6 Point Deep Socket
11	1/4" Dr x 7/32" 6 Point Deep Socket
12	1/4" Dr x 1/4" 6 Point Deep Socket
13	1/4" Dr x 9/32" 6 Point Deep Socket
14	1/4" Dr x 5/16" 6 Point Deep Socket
15	1/4" Dr x 11/32" 6 Point Deep Socket
16	1/4" Dr x 3/8" 6 Point Deep Socket
17	1/4" Dr x 7/16" 6 Point Deep Socket
18	1/4" Dr x 1/2" 6 Point Deep Socket
19	1/4" Dr x 4mm 6 Point Socket
20	1/4" Dr x 5mm 6 Point Socket
21	1/4" Dr x 6mm 6 Point Socket
22	1/4" Dr x 7mm 6 Point Socket
23	1/4" Dr x 8mm 6 Point Socket
24	1/4" Dr x 9mm 6 Point Socket
25	1/4" Dr x 10mm 6 Point Socket
26	1/4" Dr x 11mm 6 Point Socket
27	1/4" Dr x 12mm 6 Point Socket
28	1/4" Dr x 4mm 6 Point Deep Socket
29	1/4" Dr x 5mm 6 Point Deep Socket
30	1/4" Dr x 6mm 6 Point Deep Socket
31	1/4" Dr x 7mm 6 Point Deep Socket
32	1/4" Dr x 8mm 6 Point Deep Socket
33	1/4" Dr x 9mm 6 Point Deep Socket
34	1/4" Dr x 10mm 6 Point Deep Socket
35	1/4" Dr x 11mm 6 Point Deep Socket
36	1/4" Dr x 12mm 6 Point Deep Socket
37	2" Extension
38	Universal Joint
39	6" Spinner Handle
40	4" Extension
41	1/4" Ratchet Handle
42	Blow Mould Case
43	3/8" Dr x 3/8" 6 Point Socket
44	3/8" Dr x 7/16" 6 Point Socket
45	3/8" Dr x 1/2" 6 Point Socket
46	3/8" Dr x 9/16" 6 Point Socket
47	3/8" Dr x 5/8" 6 Point Socket
48	3/8" Dr x 11/16" 6 Point Socket
49	3/8" Dr x 3/4" 6 Point Socket
50	3/8" Dr x 3/8" 6 Point Deep Socket
51	3/8" Dr x 7/16" 6 Point Deep Socket
52	3/8" Dr x 1/2" 6 Point Deep Socket
53	3/8" Dr x 9/16" 6 Point Deep Socket
54	3/8" Dr x 5/8" 6 Point Deep Socket
55	3/8" Dr x 11/16" 6 Point Deep Socket
56	3/8" Dr x 3/4" 6 Point Deep Socket
57	3/8" Dr x 13/16" 6 Point Deep Socket
58	3/8" Dr x 8mm 6 Point Socket
59	3/8" Dr x 9mm 6 Point Socket
60	3/8" Dr x 10mm 6 Point Socket
61	3/8" Dr x 11mm 6 Point Socket
62	3/8" Dr x 12mm 6 Point Socket
63	3/8" Dr x 13mm 6 Point Socket
64	3/8" Dr x 14mm 6 Point Socket
65	3/8" Dr x 15mm 6 Point Socket
66	3/8" Dr x 16mm 6 Point Socket
67	3/8" Dr x 17mm 6 Point Socket
68	3/8" Dr x 18mm 6 Point Socket
69	3/8" Dr x 19mm 6 Point Socket
70	3/8" Dr x 8mm 6 Point Deep Socket
71	3/8" Dr x 9mm 6 Point Deep Socket
72	3/8" Dr x 10mm 6 Point Deep Socket
73	3/8" Dr x 11mm 6 Point Deep Socket

#### Kit Count Product Description

74	3/8" Dr x 12mm 6 Point Deep Socket
75	3/8" Dr x 13mm 6 Point Deep Socket
76	3/8" Dr x 14mm 6 Point Deep Socket
77	3/8" Dr x 15mm 6 Point Deep Socket
78	3/8" Dr x 16mm 6 Point Deep Socket
79	3/8" Dr x 17mm 6 Point Deep Socket
80	3/8" Dr x 18mm 6 Point Deep Socket
81	3/8" Dr x 19mm 6 Point Deep Socket
82	Flex Handle
83	3" Extension
84	6" Extension
85	Universal Joint
86	High Torque Ratchet
87	Blow Mould Case
88	3/8" Female - 1/4" Male Adapter
89	3/8" Female - 1/2" Male Adapter
90	1/4" Raised Panel Combination Wrench
91	5/16" Raised Panel Combination Wrench
92	3/8" Raised Panel Combination Wrench
93	7/16" Raised Panel Combination Wrench
94	1/2" Raised Panel Combination Wrench
95	9/16" Raised Panel Combination Wrench
96	5/8" Raised Panel Combination Wrench
97	11/16" Raised Panel Combination Wrench
98	3/4" Raised Panel Combination Wrench
99	13/16" Raised Panel Combination Wrench
100	7/8" Raised Panel Combination Wrench
101	15/16" Raised Panel Combination Wrench
102	1" Raised Panel Combination Wrench
103	1-1/16" Raised Panel Combination Wrench
104	1-1/8" Raised Panel Combination Wrench
105	1-1/4" Raised Panel Combination Wrench
106	Terylene Pouch
107	7mm Raised Panel Combination Wrench
108	8mm Raised Panel Combination Wrench
109	9mm Raised Panel Combination Wrench
110	10mm Raised Panel Combination Wrench
111	11mm Raised Panel Combination Wrench
112	12mm Raised Panel Combination Wrench
113	13mm Raised Panel Combination Wrench
114	14mm Raised Panel Combination Wrench
115	15mm Raised Panel Combination Wrench
116	16mm Raised Panel Combination Wrench
117	17mm Raised Panel Combination Wrench
118	18mm Raised Panel Combination Wrench
119	19mm Raised Panel Combination Wrench
120	20mm Raised Panel Combination Wrench
121	21mm Raised Panel Combination Wrench
122	22mm Raised Panel Combination Wrench
123	23mm Raised Panel Combination Wrench
124	24mm Raised Panel Combination Wrench
125	26mm Raised Panel Combination Wrench
126	27mm Raised Panel Combination Wrench
127	30mm Raised Panel Combination Wrench
128	32mm Raised Panel Combination Wrench
129	Terylene Pouch
130	10" Professional Adjustable Wrench
131	Phillips: #2 x 1-1/2" Jumbo Handle Screwdriver
132	Phillips: #1 x 3" Jumbo Handle Screwdriver
133	Phillips: #2 x 4" Jumbo Handle Screwdriver
134	Phillips: #3 x 6" Jumbo Handle Screwdriver
135	Square: #2 x 1-1/2" Jumbo Handle Screwdriver
136	Square: #1 x 4" Jumbo Handle Screwdriver
137	Square: #2 x 5" Jumbo Handle Screwdriver
138	Square: #3 x 6" Jumbo Handle Screwdriver
139	Slot Square Shaft: 1/4 x 1-1/2" Jumbo Handle Screwdriver
140	Slot Square Shaft: 1/4 x 4" Jumbo Handle Screwdriver
141	Slot Square Shaft: 5/16 x 6" Jumbo Handle Screwdriver
142	Slot Square Shaft: 3/8 x 10" Jumbo Handle Screwdriver
143	Slot Round Shaft: 3/16 x 3" Jumbo Handle Screwdriver
144	Slot Round Shaft: 3/16 x 6" Jumbo Handle Screwdriver
145	Blow Mould Case
146	T10 x 4" Jumbo Handle Torx Screwdriver

#### Kit Count Product Description

147	T15 x 4" Jumbo Handle Torx Screwdriver
148	T20 x 4" Jumbo Handle Torx Screwdriver
149	T25 x 4" Jumbo Handle Torx Screwdriver
150	T27 x 4" Jumbo Handle Torx Screwdriver
151	T30 x 4" Jumbo Handle Torx Screwdriver
152	Terylene Pouch
153	8" Slip Joint Pliers
154	8" Lineman's Pliers
155	8" Long Nose Pliers
156	7-1/2" Diagonal Cutters
157	8" Bent Nose Pliers
158	Terylene Pouch
159	6" External Straight Tip for Snap Ring Pliers
160	6" External Bent Tip for Snap Ring Pliers
161	6" Internal Straight Tip for Snap Ring Pliers
162	6" Internal Bent Tip for Snap Ring Pliers
163	Handle for Snap Ring Pliers
164	10" Curved Jaw Locking Pliers
165	9" Multifunction Wire Stripper
166	Quick Adjustable Tubing Cutter
167	16 oz Hickory Handle Ball Pen Hammer
168	1.5mm Short Arm Hex Key
169	2.0mm Short Arm Hex Key
170	2.5mm Short Arm Hex Key
171	3.0mm Short Arm Hex Key
172	4.0mm Short Arm Hex Key
173	4.5mm Short Arm Hex Key
174	5.0mm Short Arm Hex Key
175	5.5mm Short Arm Hex Key
176	6.0mm Short Arm Hex Key
177	7.0mm Short Arm Hex Key
178	8.0mm Short Arm Hex Key
179	9.0mm Short Arm Hex Key
180	10.0mm Short Arm Hex Key
181	1/16" Long Arm Hex Key
182	5/64" Long Arm Hex Key
183	3/32" Long Arm Hex Key
184	7/64" Long Arm Hex Key
185	1/8" Long Arm Hex Key
186	9/64" Long Arm Hex Key
187	5/32" Long Arm Hex Key
188	3/16" Long Arm Hex Key
189	7/32" Long Arm Hex Key
190	1/4" Long Arm Hex Key
191	5/16" Long Arm Hex Key
192	3/8" Long Arm Hex Key
193	Plastic Rack
194	12" Hacksaw Frame
195	1/8" Pin Punch
196	3/16" Pin Punch
197	1/4" Pin Punch
198	3/16" Solid Punch
199	1/2" Cold Chisel
200	5/8" Cold Chisel
201	3/4" Cold Chisel
202	5/32" Centre Punch
203	Terylene Pouch
204	18" Pry Bar
205	26" x 12" 6 Drawer B&G Series Mechanic's Chest
206	1" Short Scraper
207	Battery Post and Terminal Cleaner
208	6-12 Volt Circuit Tester
209	Long Telescoping Magnet
210	Strap Filter Wrench
211	Universal Master Feeler Gauge

# 131 PIECE UTILITY TOOL KIT

699701 / UTK-131



842124  
Included with kit

**Kit Count Product Description**

1	1/16" JET-KUT Black Oxide H.S.S. Jobber Drill Bit
2	5/64" JET-KUT Black Oxide H.S.S. Jobber Drill Bit
3	3/32" JET-KUT Black Oxide H.S.S. Jobber Drill Bit
4	7/64" JET-KUT Black Oxide H.S.S. Jobber Drill Bit
5	1/8" JET-KUT Black Oxide H.S.S. Jobber Drill Bit
6	9/64" JET-KUT Black Oxide H.S.S. Jobber Drill Bit
7	5/32" JET-KUT Black Oxide H.S.S. Jobber Drill Bit
8	11/64" JET-KUT Black Oxide H.S.S. Jobber Drill Bit
9	3/16" JET-KUT Black Oxide H.S.S. Jobber Drill Bit
10	13/64" JET-KUT Black Oxide H.S.S. Jobber Drill Bit
11	7/32" JET-KUT Black Oxide H.S.S. Jobber Drill Bit
12	15/64" JET-KUT Black Oxide H.S.S. Jobber Drill Bit
13	1/4" JET-KUT Black Oxide H.S.S. Jobber Drill Bit
14	17/64" JET-KUT Black Oxide H.S.S. Jobber Drill Bit
15	9/32" JET-KUT Black Oxide H.S.S. Jobber Drill Bit
16	19/64" JET-KUT Black Oxide H.S.S. Jobber Drill Bit
17	5/16" JET-KUT Black Oxide H.S.S. Jobber Drill Bit
18	21/64" JET-KUT Black Oxide H.S.S. Jobber Drill Bit
19	11/32" JET-KUT Black Oxide H.S.S. Jobber Drill Bit
20	23/64" JET-KUT Black Oxide H.S.S. Jobber Drill Bit
21	3/8" JET-KUT Black Oxide H.S.S. Jobber Drill Bit
22	25/64" JET-KUT Black Oxide H.S.S. Jobber Drill Bit
23	13/32" JET-KUT Black Oxide H.S.S. Jobber Drill Bit
24	27/64" JET-KUT Black Oxide H.S.S. Jobber Drill Bit
25	7/16" JET-KUT Black Oxide H.S.S. Jobber Drill Bit
26	29/64" JET-KUT Black Oxide H.S.S. Jobber Drill Bit
27	15/32" JET-KUT Black Oxide H.S.S. Jobber Drill Bit
28	31/64" JET-KUT Black Oxide H.S.S. Jobber Drill Bit
29	1/2" JET-KUT Black Oxide H.S.S. Jobber Drill Bit
30	Metal Box with Drill Index
31	1/4" Dr x 3/16" 6 Point Socket
32	1/4" Dr x 7/32" 6 Point Socket
33	1/4" Dr x 1/4" 6 Point Socket
34	1/4" Dr x 9/32" 6 Point Socket
35	1/4" Dr x 5/16" 6 Point Socket
36	1/4" Dr x 11/32" 6 Point Socket
37	1/4" Dr x 3/8" 6 Point Socket
38	1/4" Dr x 7/16" 6 Point Socket
39	1/4" Dr x 1/2" 6 Point Socket
40	1/4" Dr x 3/16" 6 Point Deep Socket
41	1/4" Dr x 7/32" 6 Point Deep Socket
42	1/4" Dr x 1/4" 6 Point Deep Socket
43	1/4" Dr x 9/32" 6 Point Deep Socket
44	1/4" Dr x 5/16" 6 Point Deep Socket
45	1/4" Dr x 11/32" 6 Point Deep Socket
46	1/4" Dr x 3/8" 6 Point Deep Socket
47	1/4" Dr x 7/16" 6 Point Deep Socket
48	1/4" Dr x 1/2" 6 Point Deep Socket
49	2" Extension
50	6" Extension

**Kit Count Product Description**

51	Universal Joint
52	6" Spinner Handle
53	1/4" Oval Head Ratchet
54	Metal Case
55	3/8" Dr x 3/8" 6 Point Socket
56	3/8" Dr x 7/16" 6 Point Socket
57	3/8" Dr x 1/2" 6 Point Socket
58	3/8" Dr x 9/16" 6 Point Socket
59	3/8" Dr x 5/8" 6 Point Socket
60	3/8" Dr x 11/16" 6 Point Socket
61	3/8" Dr x 3/4" 6 Point Socket
62	3/8" Dr x 3/8" 6 Point Deep Socket
63	3/8" Dr x 7/16" 6 Point Deep Socket
64	3/8" Dr x 1/2" 6 Point Deep Socket
65	3/8" Dr x 9/16" 6 Point Deep Socket
66	3/8" Dr x 5/8" 6 Point Deep Socket
67	3/8" Dr x 11/16" 6 Point Deep Socket
68	3/8" Dr x 3/4" 6 Point Deep Socket
69	3/8" Dr x 13/16" 6 Point Deep Socket
70	Flex Handle
71	3" Extension
72	6" Extension
73	Universal Joint
74	3/8" Oval Head Ratchet
75	Blow Mould Case
76	3/8" Dr x 5/8" Spark Plug Socket
77	3/8" Raised Panel Combination Wrench
78	7/16" Raised Panel Combination Wrench
79	1/2" Raised Panel Combination Wrench
80	9/16" Raised Panel Combination Wrench
81	5/8" Raised Panel Combination Wrench
82	11/16" Raised Panel Combination Wrench
83	3/4" Raised Panel Combination Wrench
84	13/16" Raised Panel Combination Wrench
85	7/8" Raised Panel Combination Wrench
86	15/16" Raised Panel Combination Wrench
87	1" Raised Panel Combination Wrench
88	Terylene Pouch
89	10" Professional Adjustable Wrench
90	4" Jumbo Handle Screwdriver
91	6" Jumbo Handle Screwdriver
92	#1 Jumbo Handle Phillips Screwdriver
93	#2 Jumbo Handle Phillips Screwdriver
94	#1 Square Jumbo Handle Screwdriver
95	#2 Square Jumbo Handle Screwdriver
96	Plastic Rack
97	8" Slip Joint Pliers
98	8" Lineman's Pliers
99	8" Long Nose Pliers
100	7-1/2" Diagonal Cutters

**Kit Count Product Description**

101	8" Bent Nose Pliers
102	Terylene Pouch
103	9-1/2" Groove Joint Pliers
104	10" Curved Jaw Locking Pliers
105	16 Oz Fibreglass Claw Hammer
106	0.05" Short Arm Hex Key
107	1/16" Short Arm Hex Key
108	5/64" Short Arm Hex Key
109	3/32" Short Arm Hex Key
110	7/64" Short Arm Hex Key
111	1/8" Short Arm Hex Key
112	9/64" Short Arm Hex Key
113	5/32" Short Arm Hex Key
114	3/16" Short Arm Hex Key
115	7/32" Short Arm Hex Key
116	1/4" Short Arm Hex Key
117	5/16" Short Arm Hex Key
118	3/8" Short Arm Hex Key
119	Plastic Rack
120	1/8" Pin Punch
121	3/16" Pin Punch
122	1/4" Pin Punch
123	3/16" Solid Punch
124	1/2" Cold Chisel
125	5/8" Cold Chisel
126	3/4" Cold Chisel
127	5/32" Centre Punch
128	Terylene Pouch
129	16ft Tape Measure
130	Telescopic Pick Up Tool
131	21" 3 Drawer Steel Hand Tool Box





672902



674909



670901



670926A



672927B

## REPLACEMENT PARTS

For the most part, JET Hand Tools carry a lifetime warranty. However, the following JET hand tools have wear parts that are not covered under warranty. The moving parts found on these products can wear out through normal use and can easily be replaced by purchasing and installing the repair kits indicated below.

### Flex Bar

- The swivel drive ends on these units are designed to fail before the chrome drive holder breaks under extreme use
- The drive end is easily replaced by removing the drive end screw and broken drive end and installing the replacement drive end and screw

PROD. NO.	MOD. NO.	Drive	Repair Kit
672902	SA1201	1/2"	900218
672903	SA1202	1/2"	900218
672918	SA1213	1/2"	900219
673909	SA7508	3/4"	900230
674909	SA1008	1"	900246

## RATCHETS

- Like all makes of ratchets, JET ratcheting mechanisms will wear with extensive use or break when extreme pressure or abuse is applied
- JET ratchet repair kits are available for all ratchet models and are available for purchase and easily installed by your JET hand tool distributor

### RH - Standard Duty

PROD. NO.	MOD. NO.	Drive	Repair Kit
670901	RH-25	1/4"	900202
671901	RH-38	3/8"	900203
672901	RH-50	1/2"	900204
673901	RH-75	3/4"	900205
674901	RH-100	1"	900210

### RHQ Series - Heavy Duty

PROD. NO.	MOD. NO.	Drive	Repair Kit
670926A	RHQ-14	1/4"	900235
670928	RHQ-14L	1/4"	900235
670929	RHQ-14F	1/4" (Flex)	900235
671926A	RHQ-38	3/8"	900236
671942A	RHQ-38FS	3/8"	900236
671943	RHQ-38F2	3/8" (Flex)	900253
671943A	RHQ-38F2	3/8"	900236
671945	RHQ-38L	3/8"	900236
672926B	RHQ-12	1/2"	900239
672927B	RHQ-12L	1/2"	900239
672929	RHQ-12F	1/2" (Flex)	900259
673922	RHQ-34	3/4"	900215

## RHD Series - Super Heavy Duty

PROD. NO.	MOD. NO.	Drive	Repair Kit
673923	RHD-3400	3/4"	900240
674906	RHD-1036	1"	900241

## RA Series - Ratchet Adapters

PROD. NO.	MOD. NO.	Drive	Repair Kit
670921	RA1452	1/4"	900266
671921	RA3852	3/8"	900267
672921	RA1252	1/2"	900268

## SH Series

PROD. NO.	MOD. NO.	Drive	Repair Kit
670922	SH270-14	1/4"	900261
671922	SH270-38	3/8"	900262
672922	SH270-12	1/2"	900263

## HT72 - 72 Tooth Twin Pawl Series

PROD. NO.	MOD. NO.	Drive	Repair Kit
670927	HT-1472	1/4"	900225
671928	HT-3872	3/8"	900226
672928	HT-1272	1/2"	900227
673924	HT-3472	3/4"	900228

## MHR Series - 60 Tooth Mini Head

PROD. NO.	MOD. NO.	Drive	Repair Kit
671941	MHR-3860	3/8"	900252

## SR3872 - 72 Tooth Stubby

PROD. NO.	MOD. NO.	Drive	Repair Kit
671940	SR3872	3/8"	900251
671940B	SR3872	3/8"	900251

## HSR 3800 - Rotating Head Ratchet

PROD. NO.	MOD. NO.	Drive	Repair Kit	Handle Repair Kit
671944	HSR-3800	3/8"	900257	900258



674906

673923



670921



670927



671941



718906

## TORQUE WRENCHES

### Torque Wrenches

PROD. NO.	MOD. NO.	Drive	Repair Kit
718902	JTW-1425	1/4"	PDN-JTW1425-RK
718903	JMTW-1425	1/4"	PDN-JMTW1425RK
718906	JMTW-3800	3/8"	PUT-JMTW3800
718906	JMTW-3800A	3/8"	PUT-JMTW3800A
718908	JTW-3880	3/8"	PDN-JTW3880-RK
718909	JMTW-3875	3/8"	PDN-JMTW3875-RK
718909	JMTW-3875HD	3/8"	PDN-JMTW3875A-RK
718861 - 865	Tire torque wrenches	1/2"	PDN-JTTW-RK
718911	JTW-12150	1/2"	PDN-JTW12150-RK
718912	JTW-12250	1/2"	PDN-JTW12250-RK
718913	JMTW-12150	1/2"	PDN-JMTW12250-RK
718913	JMTW-12150HD	1/2"	PDN-JMTW12250A-RK
718914	JMTW-12250 (black handle)	1/2"	PDN-JMTW12250-RK
718914	JMTW-12250 (red handle)	1/2"	PDN-JTW12250-RK
718914	JMTW-12250HD (go through plug)	1/2"	PDN-JMTW12250A-RK
718933	JPTW-38100	3/8"	PDN-JPTW38100-RK
718935	JPTW-12150	1/2"	PDN-JPTW12150-RK
718936	JPTW-12250	1/2"	PDN-JPTW12250-RK
719069	JMTW-5250	1/2"	PUT-JMTW5250
719069	JMTW-5250A	1/2"	PUT-JMTW5250A
718916	JMTW-7500	3/4"	PUT-JMTW7500
718917	JTW-34300	3/4"	PDN-JTW34600-RK
718918	JTW-34600	3/4"	PDN-JTW34600-RK
718922	JTW-10700	1"	PDN-JTW10700-RK

## PIPE WRENCHES

### Pipe Wrenches - HD and AL Series

Jaw Size	Hook Jaw	Knurls	Heel Jaw	Springs
8"	PMZ-1020802	PMZ-1020804	PMZ-1020815	PMZ-1020813
10"	PMZ-1021002	PMZ-1021004	PMZ-1021015	PMZ-1021013
12"	PMZ-1021202	PMZ-1021204	PMZ-1021215	PMZ-1021213
14"	PMZ-1021402	PMZ-1021404	PMZ-1021415	PMZ-1021413
18"	PMZ-1021802	PMZ-1021804	PMZ-1021815	PMZ-1021813
24"	PMZ-1022402	PMZ-1022404	PMZ-1022415	PMZ-1022413
36"	PMZ-1023602	PMZ-1023604	PMZ-1023615	PMZ-1023613
48"	PMZ-1044802	PMZ-1044804	PMZ-1044815	PMZ-1044813

### Pipe Wrenches - PW and PWA Series

Jaw Size	Hook Jaw	Knurls	Heel Jaw	Springs
8"	PDN-PW8HJ	PDN-PW8NT	PDN-PW8HJP	PDN-PW8SF
10"	PDN-PW10HJ	PDN-PW10NT	PDN-PW10HJP	PDN-PW10SF
12"	PDN-PW12HJ	PDN-PW12NT	PDN-PW12HJP	PDN-PW12SF
14"	PDN-PW14HJ	PDN-PW14NT	PDN-PW14HJP	PDN-PW14SF
18"	PDN-PW18HJ	PDN-PW18NT	PDN-PW18HJP	PDN-PW18SF
24"	PDN-PW24HJ	PDN-PW24NT	PDN-PW24HJP	PDN-PW24SF
36"	PDN-PW36HJ	PDN-PW36NT	PDN-PW36HJP	PDN-PW36SF
48"	PDN-PW48HJ	PDN-PW48NT	PDN-PW48HJP	PDN-PW48SF



710230

# CUSHION GRIP MULTI-BIT DRIVERS

## Replacement Bits



### For 720531 (JKMD-5S) / 720534 (JKMD-10)

PROD. NO.	Size
720580	3/16" SLOT x #1 PHILLIPS
720581	3/16" SLOT x #2 SQUARE
720582	1/4" SLOT x #2 PHILLIPS
720583	#1 SQUARE x #2 SQUARE
720584	#3 PHILLIPS x #3 PHILLIPS



### For 720533 (JKMD-6 / 720590 (JRSD-19)

PROD. NO.	Size
720592	1/8" SLOT x #0 PHILLIPS
720593	3/16" SLOT x #1 PHILLIPS
720594	1/4" SLOT x #2 PHILLIPS
720595	#1 SQUARE x #2 SQUARE
720596	T10 x T15 TORX*
720597	T20 x T25 TORX*
720598	1/8" HEX x 3/16" HEX
720599	5/16" SLOT x #3 PHILLIPS



# MULTI-BIT DRIVERS

## Replacement Bits

### Replacement Bits

Replacement Bit For H3400 (P0 - P3)	H3400C
Replacement Bit For H3400 (P1 - P2)	H3400D
Replacement Bit For H3400 (S1 - S2)	H3400E
Replacement Bit For H3400 (T10 - T15)	H3400F
Replacement Bit For H3400 (T20 - T25)	H3400G
Replacement Bit For H3400 (T27 - T30)	H3400H
Replacement Bit For H3400 (F4 - F6)	H3400J
Replacement Bit For H3400 (S0 - S3)	H3400K





# WARRANTY

## WARRANTY POLICY

**JET EQUIPMENT & TOOLS LTD. (JET)**, makes every effort to ensure its products are manufactured to the highest standards and each is warranted against defects in materials and workmanship for the useful life of the product when used for the purpose for which it was designed.

This warranty applies only to JET products purchased new from a JET authorized distributor. JET product warranties are extended to the original retail purchaser only.

This warranty does not apply to any product showing signs of abuse, misuse, alteration, or having been improperly maintained or repaired.

This warranty does not cover damage attributable to normal wear and tear.

Any JET product that fails during normal use and is within the specified warranty period for that product will be repaired or replaced at JET's discretion. Repairs and/or replacements are warranted as described for the specific product and only for the remainder of the original warranty period.

Repair or replacement is the exclusive remedy for defective product under this warranty. Warranty is expressly in lieu of all other warranties, including the implied warranty of merchantability or any implied warranty of fitness for a particular application.

Any JET product for which there is a warranty claim should be returned PREPAID to an authorized JET distributor or service center. Authorized Warranty Depots are found at [www.surewerx.com](http://www.surewerx.com)

ALL warranty claims must be accompanied by proof of purchase and an explanation of the defect or failure. It is the customer's responsibility to provide this information.

JET shall not be held liable for any consequential or incidental damages for breach of any expressed or implied warranty on their products.

No claims for damages of any type will be considered and all products are sold with this understanding.

Any costs incurred to obtain warranty consideration or services are the Customer's responsibility including shipping and handling, travel, lost time, or lost production.

### EXCEPT AS LISTED BELOW, ALL JET HAND TOOL PRODUCTS ARE COVERED BY OUR LIMITED LIFETIME WARRANTY

*NOTE: Specifically excluded from this guarantee are reducing adaptors, thin wall power sockets, mag wheel power sockets, power bits and insert bits and accessories, hacksaw blades, scratch brushes, damaged insulating materials, kneeling pads, consumable components*

### INDESTRUCTIBLE HANDLE HAMMERS - LIMITED LIFETIME WARRANTY

Warranty extends to fracturing or permanent deformation of the handle only, and only when used for its intended purpose. Heads are warranted not to suffer a complete

separation; however in time it is possible the locking plate will begin to bend, indicating the tool has reached its useful life and may indicate the need for a heavier hammer. Chips, cracks, and cuts to the rubber overmould are excluded from this warranty.

### TWO YEAR WARRANTY

Machinery  
Torque Wrenches

*NOTE: Dropping or striking against hard objects, using for removal of fasteners, or failure to return wrench to lowest setting can all contribute to loss of accuracy and is not the fault of the tool.*

### ONE YEAR WARRANTY

Hose Reels (hose is discretionary based on examination)  
Lubricating Equipment (seals and hoses excluded)  
Torque Multipliers  
Precision Measuring Tools  
Electronic Measuring Tools Thermometers  
Tire Gauges Compression/Pressure Gauges  
Automotive Gauges  
Timing Lights  
Pry Bars and Wrecking Bars  
Gear Pullers, Bearing Separators  
Crawlers/Seats

### CALIBRATION IS NOT COVERED BY WARRANTY EXCEPT WHEN REQUIRED DUE TO WARRANTY REPAIR SERVICE

*NOTE: Batteries supplied with certain products may have been exposed to a long shelf life resulting in low energy or dead batteries. Please source replacement batteries locally. Dead batteries do not constitute a warranty claim.*

### REPAIRABLE WEAR PARTS

Flex Bar Swivels, Ratchet Repair Kits, Torque Wrench Repair Kits, Pipe Wrench Jaws, Springs and Knurls, Bolt Cutter heads, Bench Vise (excluding casting).

### TOOL BOXES

Tool boxes are warranted against defects in materials and workmanship when used for the purpose for which they were designed for the periods specified below. Moving heavily loaded tool boxes is the most common cause of damage. If the tool box must be moved regularly choose one of a sufficient duty rating.

Super Pro, SHD, Treasure Series - Limited Lifetime  
Pro Series and B&G Series - 5 years

SUMO Series, jobsite, truck box, and hand held tool boxes- 2 years

Rolling tool carts - 1 year

*NOTE: Evidence of drawer overload, shock, impact, use as a mobile tool box (unless specifically designed for this purpose) or lack of maintenance voids warranty.*