



Nothing but **HEAVY DUTY.**

ULTIMATE PRODUCTIVITY. SUPERIOR PERFORMANCE.



HAND TOOLS | STORAGE | SAFETY
SPRING 2020

STUD™ TAPE MEASURES

INDUSTRY'S MOST DURABLE TAPE MEASURE

17' REACH*

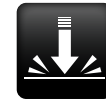

SURVIVES 80' DROP**

Fully Reinforced, Impact Resistant Frame



Rip & Wear Resistant Blade

Model #	Description
48-22-9716	16ft STUD™ Tape Measure with 16' Reach*
48-22-9725	25ft STUD™ Tape Measure with 17' Reach*
48-22-9735	35ft STUD™ Tape Measure with 17' Reach*

Model #	Description
48-22-9717	5m/16ft STUD™ Tape Measure with 16' Reach*
48-22-9726	8m/26ft STUD™ Tape Measure with 17' Reach*
48-22-9725M	25ft STUD™ Magnetic Tape Measure with 17' Reach*

WIDE BLADE TAPE MEASURES

LONGEST REACH STRAIGHTEST STANDOUT†

17' REACH*

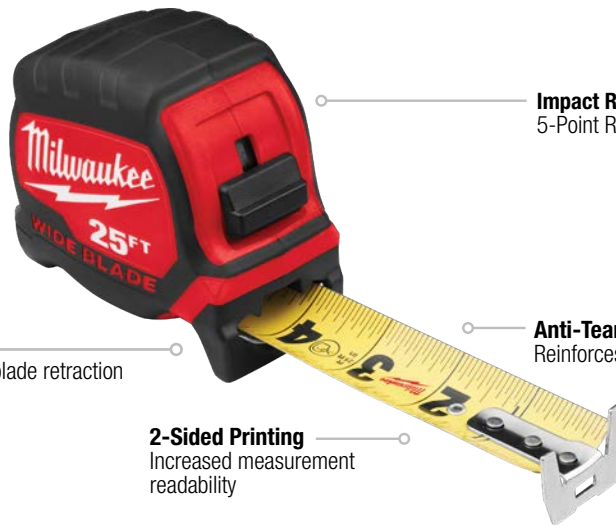

Long Reach for Efficient Measuring

Model #	Description
48-22-0216	16ft Wide Blade Tape Measure with 16' Reach*
48-22-0225	25ft Wide Blade Tape Measure with 17' Reach*
48-22-0230	30ft Wide Blade Tape Measure with 17' Reach*
48-22-0235	35ft Wide Blade Tape Measure with 17' Reach*
48-22-0240	40ft Wide Blade Tape Measure with 17' Reach*

Model #	Description
48-22-0217	5m/16ft Wide Blade Tape Measure with 16' Reach*
48-22-0226	8m/26ft Wide Blade Tape Measure with 17' Reach*
48-22-0216M	16ft Wide Blade Magnetic Tape Measure with 16' Reach*
48-22-0225M	25ft Wide Blade Magnetic Tape Measure with 17' Reach*

COMPACT WIDE BLADE TAPE MEASURES

15' REACH*

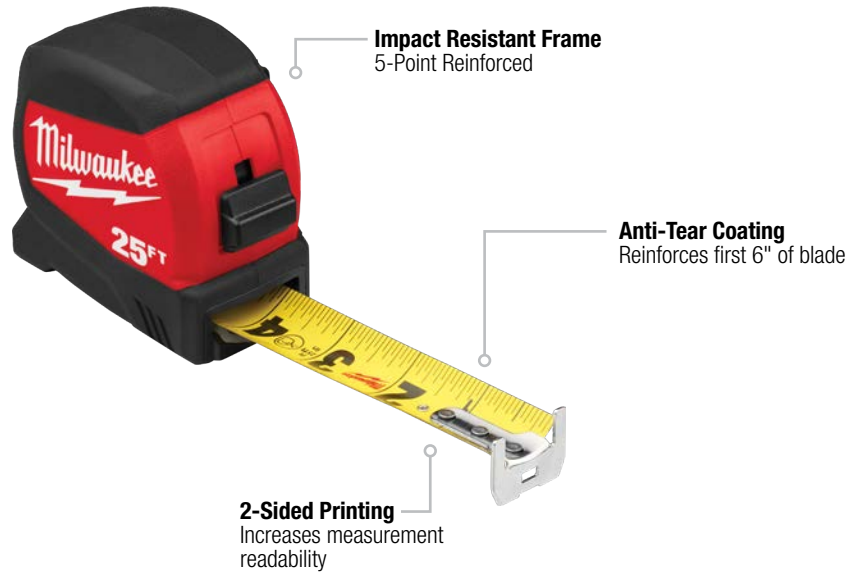

2-Sided Printing

Model #	Description
48-22-0416	16ft Compact Wide Blade Tape Measure with 15' Reach*
48-22-0425	25ft Compact Wide Blade Tape Measure with 15' Reach*
48-22-0430	30ft Compact Wide Blade Tape Measure with 15' Reach*
48-22-0417	5m/16ft Compact Wide Blade Tape Measure with 15' Reach*
48-22-0426	8m/26ft Compact Wide Blade Tape Measure with 15' Reach*
48-22-0316	16ft Compact Wide Blade Magnetic Tape Measure with 15' Reach*

Model #	Description
48-22-0325	25ft Compact Wide Blade Magnetic Tape Measure with 15' Reach*
48-22-0335	35ft Compact Wide Blade Magnetic Tape Measure with 15' Reach*
48-22-0317	5m/16ft Compact Wide Blade Magnetic Tape Measure with 15' Reach*
48-22-0326	8m/26ft Compact Wide Blade Magnetic Tape Measure with 15' Reach*

COMPACT TAPE MEASURES

12' REACH*

Impact Resistant Frame
5-Point Reinforced

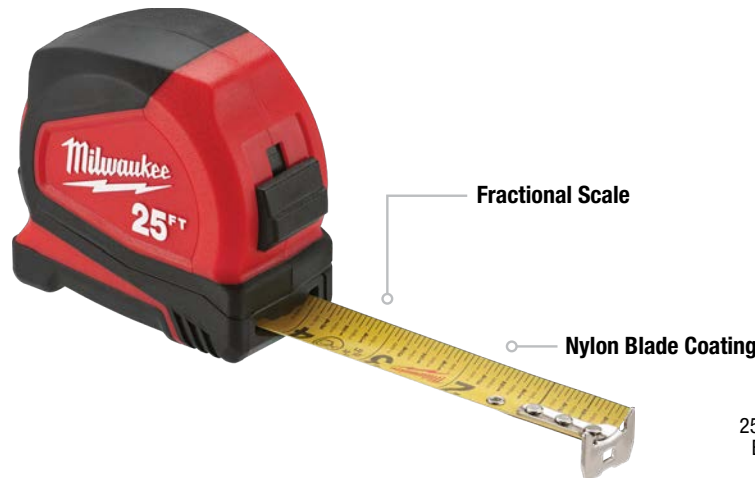

Also Available:



25ft Compact Tape Measure with Engineer Scale with 12' Reach*
48-22-6625E



Nylon Blade Coating

Model #	Description
48-22-6612	12ft Compact Tape Measure with 12' Reach*
48-22-6616	16ft Compact Tape Measure with 12' Reach*
48-22-6625	25ft Compact Tape Measure with 12' Reach*
48-22-6630	30ft Compact Tape Measure with 12' Reach*
48-22-6613	3m/12ft Compact Tape Measure with 12' Reach*
48-22-6617	5m/16ft Compact Tape Measure with 12' Reach*
48-22-6626	8m/26ft Compact Tape Measure with 12' Reach*

Model #	Description
48-22-6816	16ft Compact Auto-Lock Tape Measure with 12' Reach*
48-22-6825	25ft Compact Auto-Lock Tape Measure with 12' Reach*
48-22-6817	5m/16ft Compact Auto-Lock Tape Measure with 12' Reach*
48-22-6826	8m/26ft Compact Auto-Lock Tape Measure with 12' Reach*
48-22-5506	2m/6ft Keychain Tape Measure
48-22-6601	10ft/3m Keychain Tape Measure with LED

OPEN REEL LONG TAPES

50% LESS STRETCH

3:1 Metal Planetary Gears
Prevents gear stripping & stress



GRIME GUARD™ Blade Wiper
Smoothest retraction

Nylon Bond

Kink-Resistant Blade

2-Sided Printing

FIBERGLASS LONG TAPES

SMOOTHEST RETRACTION

3:1 Metal Planetary Gears
Prevents gear stripping & stress



2-Sided Printing

GRIME GUARD™ Blade Wiper
Smoothest retraction

Model #	Description
48-22-5201	100ft Open Reel Steel Long Tape
48-22-5230	300ft Open Reel Steel Long Tape

Model #	Description
48-22-5301	100ft Fiberglass Open Reel Long Tape
48-22-5302	200ft Fiberglass Open Reel Long Tape
48-22-5303	300ft Fiberglass Open Reel Long Tape
48-22-5310	100m/330ft Fiberglass Open Reel Long Tape
48-22-5330	30m/100ft Fiberglass Open Reel Long Tape
48-22-5360	60m/200ft Fiberglass Open Reel Long Tape

CLOSED REEL LONG TAPE

LONGEST LIFE

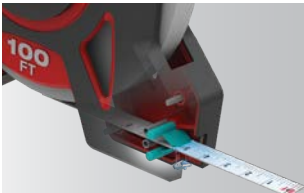

GRIME GUARD™
Industry's First Blade Wiper

3:1 Torque Dispersing Planetary Gears
Prevents gear stripping & stress

Reinforced Metal Frame



GRIME GUARD™ Blade Wiper
Smoothest retraction

Nylon Coated Blade

2-Sided Printing

Model #	Description
48-22-5101	100ft Closed Reel Long Tape

MEASURING WHEELS

MOST DURABLE. MOST ACCURATE.

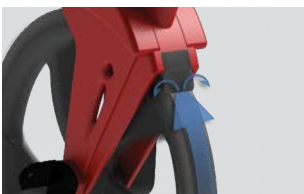

Debris Cleaning Wheel Flap

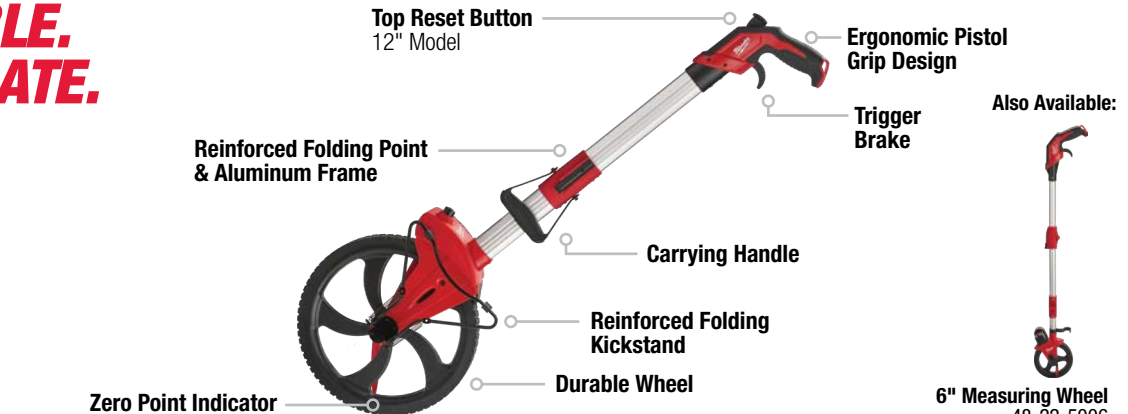

Model #	Description
48-22-5012	12" Measuring Wheel
48-22-5013	12" Engineer's Measuring Wheel

Model #	Description
48-22-5006	6" Measuring Wheel

REDSTICK™ CONCRETE LEVELS & TORPEDO LEVELS

REDSTICK™ DIGITAL LEVELS

**SUPERIOR ACCURACY.
DYNAMIC READOUT.**

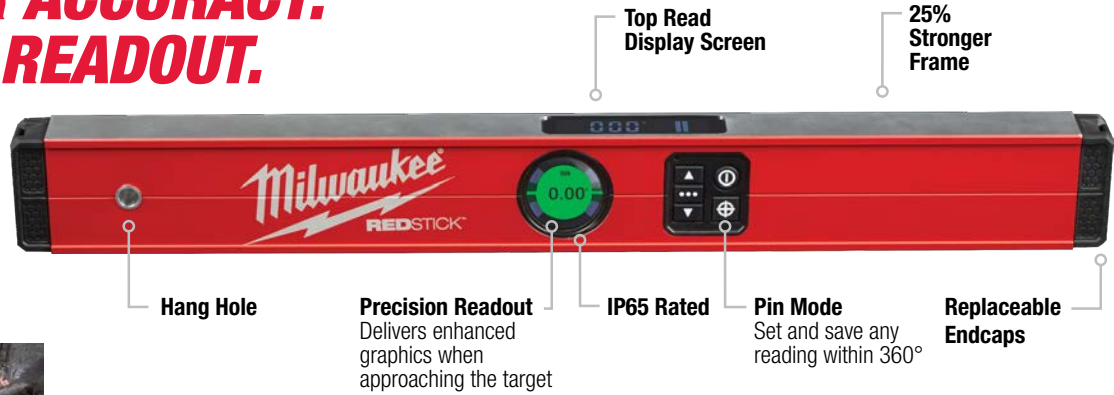

PINPOINT™ Measurement Technology

Model #	Description
MLDIG14	14" REDSTICK™ Digital Level with PINPOINT™ Measurement Technology
MLDIG24	24" REDSTICK™ Digital Level with PINPOINT™ Measurement Technology
MLDIG48	48" REDSTICK™ Digital Level with PINPOINT™ Measurement Technology
MLDIG72	72" REDSTICK™ Digital Level with PINPOINT™ Measurement Technology

REDSTICK™ BOX LEVELS

**MOST DURABLE.
GUARANTEED ACCURACY.**

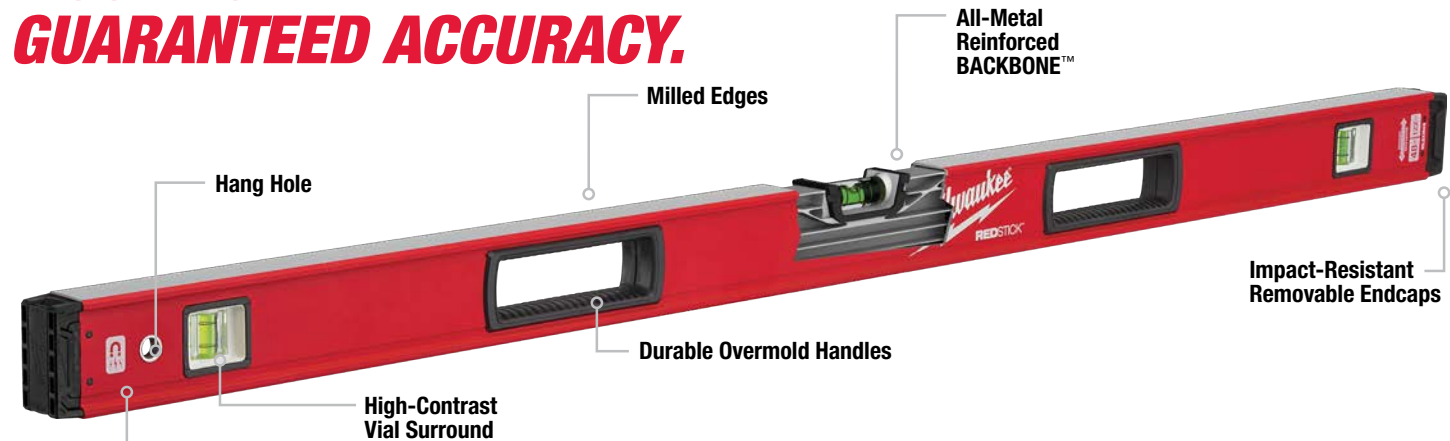

Amplified Rare-Earth Magnets

Model #	Description
MLBX16	16" REDSTICK™ Box Level
MLBXM16	16" REDSTICK™ Magnetic Box Level
MLBX24	24" REDSTICK™ Box Level
MLBXM24	24" REDSTICK™ Magnetic Box Level
MLBX32	32" REDSTICK™ Box Level
MLBXM32	32" REDSTICK™ Magnetic Box Level
MLBX36	36" REDSTICK™ Box Level
MLBXM36	36" REDSTICK™ Magnetic Box Level
MLBX48	48" REDSTICK™ Box Level
MLBXM48	48" REDSTICK™ Magnetic Box Level
MLBX59	59" REDSTICK™ Box Level
MLBXM59	59" REDSTICK™ Magnetic Box Level
MLBX72	72" REDSTICK™ Box Level
MLBXM72	72" REDSTICK™ Magnetic Box Level

Model #	Description
MLBX78	78" REDSTICK™ Box Level
MLBXM78	78" REDSTICK™ Magnetic Box Level
MLBX96	96" REDSTICK™ Box Level
MLBXM96	96" REDSTICK™ Magnetic Box Level
MLBXS1648	16" / 48" REDSTICK™ Box Level Set
MLBXS48	24" / 48" REDSTICK™ Box Level Set
MLBXS48M	24" / 48" REDSTICK™ Magnetic Box Level Set
MLBXJB	78" / 32" REDSTICK™ Box Level Jamb Set
MLBXJBM	78" / 32" REDSTICK™ Magnetic Box Level Jamb Set
MLSB48	48" Level Bag
MLSB78	78" Level Bag
MLBXC48	4 Pc REDSTICK™ Starter Set
MLBXC78	5 Pc REDSTICK™ Master Set

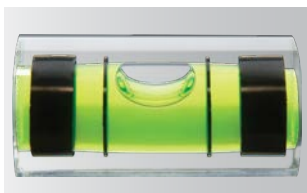

SHARPSITE™ Vial Technology

REDSTICK™ COMPACT BOX LEVELS

COMPACT DURABILITY

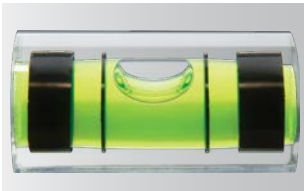

SHARPSITE™ Vial Technology

Model #	Description
MLCM24	24" REDSTICK™ Compact Box Level
MLCMM24	24" REDSTICK™ Magnetic Compact Box Level
MLCM48	48" REDSTICK™ Compact Box Level
MLCMM48	48" REDSTICK™ Magnetic Compact Box Level
MLCM72	72" REDSTICK™ Compact Box Level

Model #	Description
MLCMM72	72" REDSTICK™ Magnetic Compact Box Level
MLCMS48	24" / 48" REDSTICK™ Compact Box Level Set
MLCMSM48	24" / 48" REDSTICK™ Magnetic Compact Box Level Set

REDSTICK™ EXPANDABLE LEVELS

FRAME MORE. NO MAINTENANCE.



Reinforced Components & Durable Lock



Also Available:

Expandable Level Storage Bag
MLXPSB

Model #	Description
MLXPM78	48" – 78" REDSTICK™ Magnetic Expandable Level
MLXP712	6-1/2' – 12' REDSTICK™ Expandable Level

REDSTICK™ CONCRETE LEVELS & TORPEDO LEVELS

REDSTICK™ CONCRETE LEVELS

BUILT FOR CONCRETE



Screed



Smooth



Clean

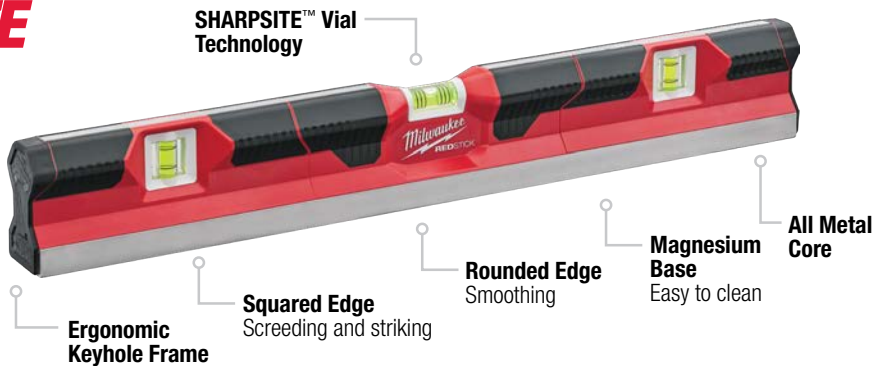

Model #	Description
MLCON24	24" REDSTICK™ Concrete Level
MLCON48	48" REDSTICK™ Concrete Level
MLCON72	72" REDSTICK™ Concrete Level

BILLET TORPEDO LEVELS

STRONGEST MAGNETS. EASIEST PITCH SET.



4 Amplified Rare-Earth Magnets

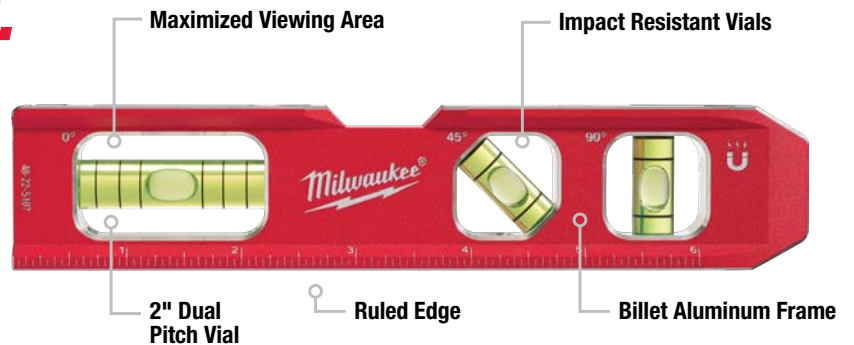

Model #	Description
48-22-5107	Billet Torpedo Level
48-22-5207	Metric Billet Torpedo Level

BLOCK TORPEDO LEVEL

STRONGEST MAGNETS. 360° ACCURACY.



Amplified Rare-Earth Magnets

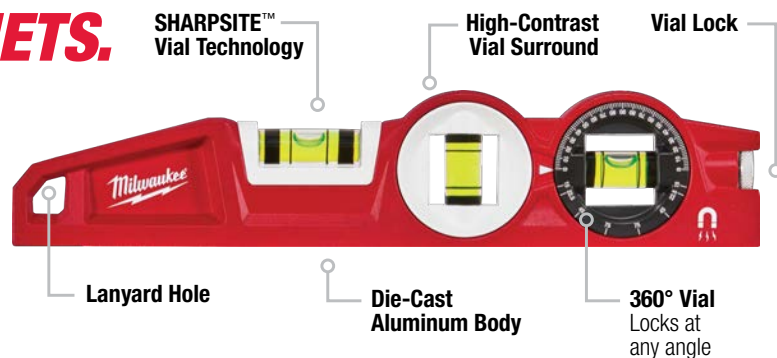

Model #	Description
48-22-5210	Block Torpedo Level
48-22-5102	360° Pocket Level

Model #	Description
48-22-5603	Pocket Level
48-22-5001	Pipe Lock Level

RAFTER SQUARES

**STRONGER FRAME.
MOST VERSATILE.**

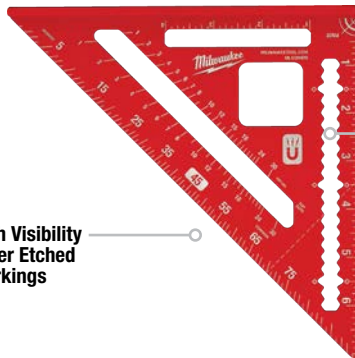

High Visibility Laser Etched Markings

Scribe Notches

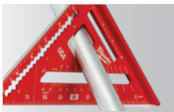

1" Cutout Props Pipe

Model #	Description
MLSQM070	7" Magnetic Rafter Square
MLSQ170	180mm Rafter Square

TRIM SQUARE

**MOST COMPACT.
MOST VERSATILE.**

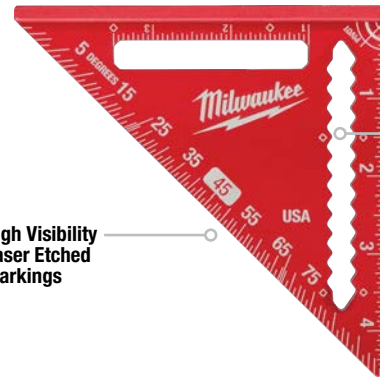

High Visibility Laser Etched Markings

Precision Scribe Notches at 1/8" Increments



Dual Reference Heel

Model #	Description
MLSQ040	4-1/2" Trim Square

FRAMING SQUARES

**STRONGER THAN STEEL.
MOST VERSATILE.**

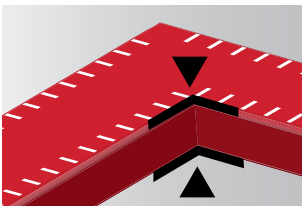

Thicker Frame

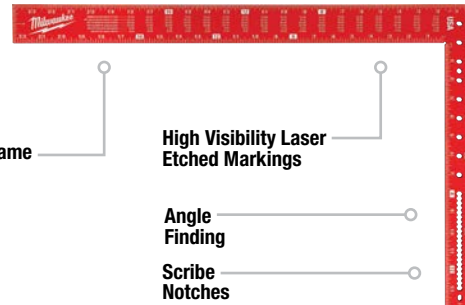

Reinforced Frame

High Visibility Laser Etched Markings

Angle Finding

Scribe Notches

Model #	Description
MLSQ024	16" x 24" Framing Square
MLSQ124	400mm x 600mm Framing Square

LASER DISTANCE METERS

**EASIEST
MEASUREMENTS**



Simplified User Interface

2" Backlit Color Screen

Continuous Real-Time Measurements

2-Position Auto-Detecting Lever



Impact-Resistant Overmolding

Side-Shot Button
Allows for one-handed measurement in all situations

Also Available:



65ft Laser Distance Meter
48-22-9801

Model #	Description
48-22-9801	65ft Laser Distance Meter
48-22-9802	150ft Laser Distance Meter

Model #	Description
48-22-9803	330ft Laser Distance Meter

FOLDING RULES & CHALK REELS

FOLDING RULES

MOST DURABLE MARKINGS & BLADES

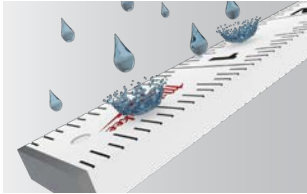

Water & Scratch Resistant Laminate

Quick Reference Bend Angles
22.5°, 30°, 45° & 60°

Heat-Stamped Markings
Won't wear

Corrosion-Free Embedded Joints
Locks at 0°, 90° & 180°



Model #	Description
48-22-3801	6-1/2ft Composite Folding Rule
48-22-3802	6-1/2ft Engineer's Composite Folding Rule

CHALK REELS

LONGEST GEAR LIFE. BEST PERFORMANCE.



Bold Line

1.5mm High-Strength Braided Line

6X Faster Retraction



Fine Line

0.9mm High-Strength Braided Line

Aluminum Body
Fine line model only



StripGuard™ Clutch & Planetary Gears

Model #	Description
48-22-3980	100ft Bold Line Chalk Reel
48-22-3982	100ft Bold Line Chalk Reel & Blue Chalk Refill
48-22-3986	100ft Bold Line Chalk Reel & Red Chalk Refill
48-22-3989	Bold Replacement Line

Model #	Description
48-22-3990	100ft Fine Line Chalk Reel
48-22-3992	100ft Fine Line Chalk Reel & Blue Chalk Refill
48-22-3993	100ft Chalk Reel Kit with Blue Chalk Refill
48-22-3999	Fine Replacement Line

EXTRA BOLD LARGE CAPACITY CHALK REELS

LONGEST GEAR LIFE. BEST PERFORMANCE.



Planetary Gears Prevent Stripping

24oz Chalk Capacity

4:1 Retraction Speed

Refillable Base



Easy Grip Metal Handle

Quick Turn Opening

Model #	Description
48-22-3910	100ft Extra Bold Large Capacity Chalk Reel
48-22-3900	100ft Extra Bold Replacement Line

Model #	Description
48-22-3915	150ft Extra Bold Large Capacity Chalk Reel
48-22-3905	150ft Extra Bold Replacement Line

INKZALL™ JOBSITE MARKERS

**WRITES ON
DUST
WET
OILY
SURFACES**



Clog Resistant

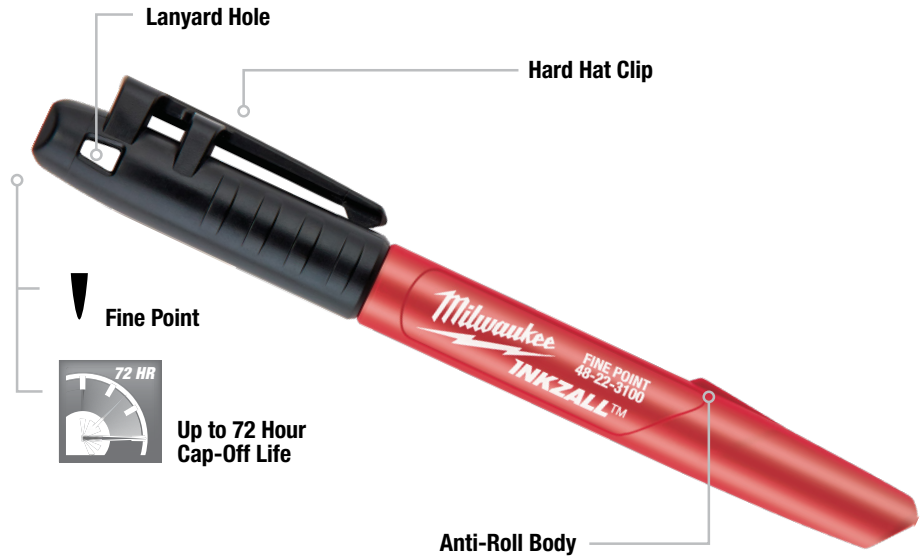

Model #	Description
48-22-3150	12 Pc INKZALL™ Ultra Fine Point Black Jobsite Markers
48-22-3154	4 Pc INKZALL™ Ultra Fine Point Black Jobsite Markers
48-22-3104	4 Pc INKZALL™ Fine Point Black Jobsite Markers
48-22-3105	2 Pc INKZALL™ Fine Point Black Jobsite Markers
48-22-3107	8 Pc INKZALL™ Fine Point Color Jobsite Markers
48-22-3106	4 Pc INKZALL™ Fine Point Color Jobsite Markers
48-22-3101	INKZALL™ Stylus and Fine Point Black Jobsite Markers
48-22-3102	2 Pc INKZALL™ Medium Point Black Jobsite Markers
48-22-3103	INKZALL™ Chisel Tip Black Jobsite Markers
48-22-3109	4 Pc INKZALL™ Chisel Tip Color Jobsite Markers
48-22-3100	INKZALL™ Fine Point Black Jobsite Markers (Bulk 36 Pc)
48-22-3130	INKZALL™ Chisel Tip Black Jobsite Markers (Bulk 36 Pc)

Model #	Description
48-22-3170	INKZALL™ Fine Point Red Jobsite Markers (Bulk 36 Pc)
48-22-3180	INKZALL™ Fine Point Blue Jobsite Markers (Bulk 36 Pc)
48-22-3190	INKZALL™ Fine Point Green Jobsite Markers (Bulk 36 Pc)
48-22-3209	12 Pc INKZALL™ Fine Point Black Jobsite Markers
48-22-3250	3 Pc INKZALL™ Large Chisel Tip Black Jobsite Markers
48-22-3255	INKZALL™ Large Chisel Tip Black Jobsite Markers (Bulk 12 Pc)
48-22-3256	INKZALL™ Large Chisel Tip Red Jobsite Markers (Bulk 12 Pc)
48-22-3257	INKZALL™ Large Chisel Tip Blue Jobsite Markers (Bulk 12 Pc)
48-22-3260	INKZALL™ Extra Large Chisel Tip Black Jobsite Markers
48-22-3265	INKZALL™ Extra Large Chisel Tip Black Jobsite Markers (Bulk 12 Pc)
48-22-3266	INKZALL™ Extra Large Chisel Tip Red Jobsite Markers (Bulk 12 Pc)
48-22-3267	INKZALL™ Extra Large Chisel Tip Blue Jobsite Markers (Bulk 12 Pc)

INKZALL™ METALLIC MARKERS



Visible on Dark Surfaces



Model #	Description
48-22-3121	2 Pc INKZALL™ Fine Point Silver Metallic Marker
48-22-3122	2 Pc INKZALL™ Fine Point Gold Metallic Marker
48-22-3123	2 Pc INKZALL™ Fine Point Silver/Gold Metallic Marker

INKZALL™ PAINT MARKERS, PENS & HIGHLIGHTERS

INKZALL™ LIQUID PAINT MARKERS

BLEED & SMEAR RESISTANT



Marks on Surfaces up to 300°F

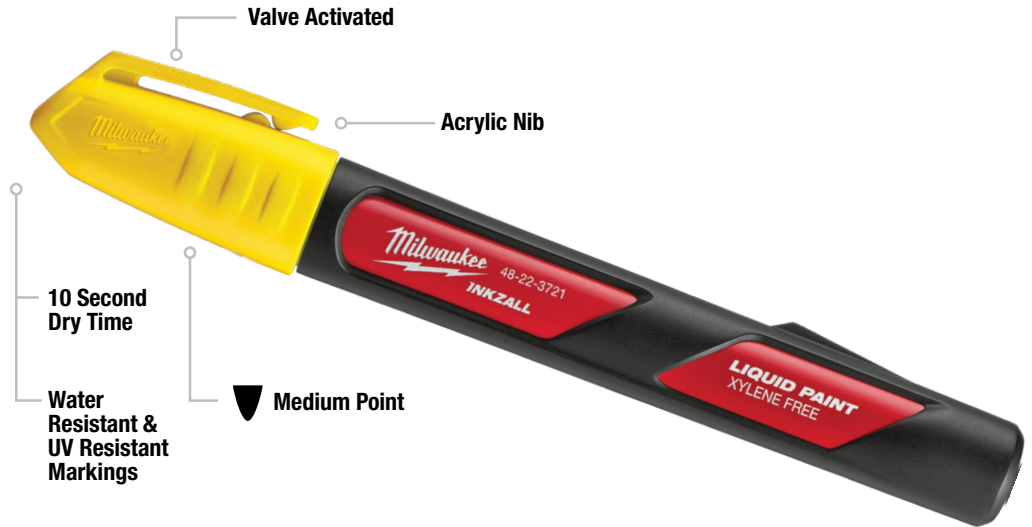

Model #	Description
48-22-3712	INKZALL™ Medium Point White Liquid Paint Marker
48-22-3722	INKZALL™ Medium Point Yellow Liquid Paint Marker
48-22-3711	INKZALL™ Medium Point White Liquid Paint Marker (Bulk 12 Pc)
48-22-3721	INKZALL™ Medium Point Yellow Liquid Paint Marker (Bulk 12 Pc)
48-22-3731	INKZALL™ Medium Point Black Liquid Paint Marker (Bulk 12 Pc)

Model #	Description
48-22-3741	INKZALL™ Medium Point Red Liquid Paint Marker (Bulk 12 Pc)
48-22-3751	INKZALL™ Medium Point Green Liquid Paint Marker (Bulk 12 Pc)
48-22-3761	INKZALL™ Medium Point Blue Liquid Paint Marker (Bulk 12 Pc)
48-22-3771	INKZALL™ Medium Point Orange Liquid Paint Marker (Bulk 12 Pc)

INKZALL™ JOBSITE PENS

SHARP, PRECISE LINES



Model #	Description
48-22-3160	12 Pc INKZALL™ Ultra Fine Point Black Jobsite Pen
48-22-3161	12 Pc INKZALL™ Ultra Fine Point Red Jobsite Pen
48-22-3162	12 Pc INKZALL™ Ultra Fine Point Blue Jobsite Pen
48-22-3164	4 Pc INKZALL™ Ultra Fine Point Black Jobsite Pen
48-22-3165	4 Pc INKZALL™ Ultra Fine Point Color Jobsite Pen

INKZALL™ JOBSITE HIGHLIGHTERS

UP TO 4x LONGER LIFE



Model #	Description
48-22-3201	5 Pc INKZALL™ Chisel Tip Yellow Jobsite Highlighter
48-22-3206	5 Pc INKZALL™ Chisel Tip Colored Jobsite Highlighter

COMFORT GRIP STRAIGHT JAW PLIERS

REAM AND PUNCH™



Ream

Punch



Model #	Description	Jaw Capacity	Reaming Capacity
48-22-6306	6" Comfort Grip Straight Jaw Pliers	1"	3/4"
48-22-6310	10" Comfort Grip Straight Jaw Pliers	2"	2"
48-22-6312	12" Comfort Grip Straight Jaw Pliers	2-1/4"	2-3/4"
48-22-6316	16" Comfort Grip Straight Jaw Pliers	4-1/4"	3"
48-22-6320	20" Comfort Grip Straight Jaw Pliers	5-1/2"	3-1/2"
48-22-6330	2 Pc 6" & 10" Comfort Grip Straight Jaw Pliers Set	1" & 2"	3/4" & 2"
48-22-6331	3 Pc Comfort Grip Pliers Set	2"	2"

STRAIGHT JAW PLIERS

MAXIMUM GRIP. FORGED STRENGTH.



Reaming Head

Model #	Description	Jaw Capacity	Reaming Capacity
48-22-6510	10" Straight Jaw Pliers	2"	2"
48-22-6512	12" Straight Jaw Pliers	2-1/4"	2-3/4"

SMOOTH JAW PLIERS

SMOOTH JAW PROTECTS SURFACES



Non-Marring Smooth Jaw
for Finish Applications

Model #	Description	Jaw Capacity	Reaming Capacity
48-22-6550	10" Smooth Jaw Pliers	2"	2"
48-22-6552	12" Smooth Jaw Pliers	2-1/4"	2-3/4"

FASTENING & CUTTING PLIERS

V-JAW PLIERS



HEX JAW
BEST FIT. STRONG HOLD.

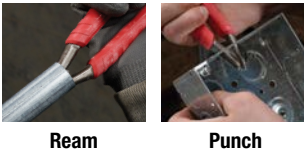

Ream

Punch

Model #	Description	Jaw Capacity	Reaming Capacity
48-22-6208	8" Comfort Grip V-Jaw Pliers	1-1/2"	1-1/2"
48-22-6210	10" Comfort Grip V-Jaw Pliers	2"	2"
48-22-6212	12" Comfort Grip V-Jaw Pliers	2-3/4"	2-3/4"

LINEMAN'S PLIERS

MAXIMUM LEVERAGE.
EASIER CUTS.*



Easily Cuts #2 ACSR

Model #	Description
48-22-6100	Comfort Grip High-Leverage Lineman's Pliers with Crimper
48-22-6500	High-Leverage Lineman's Pliers with Crimper
48-22-6502	High-Leverage Lineman's Pliers
48-22-6503	High-Leverage Lineman's Pliers with Thread Cleaner

ANGLED HEAD PLIERS

BETTER ACCESS



Angled Head

Model #	Description
48-22-6128	8" Comfort Grip Angled Head Diagonal Cutting Pliers
48-22-6528	8" Angled Head Diagonal Cutting Pliers

* When compared to other ACSR cutting lineman pliers

LONG NOSE PLIERS

LONG REACH



2" Gripping Nose

Also Available:



8" Long Nose Pliers
48-22-6501

Model #	Description
48-22-6101	8" Comfort Grip Long Nose Pliers
48-22-6501	8" Long Nose Pliers

DIAGONAL PLIERS

UP TO 2X MORE CUTS

IRON-CARBIDE EDGE



Tapered Nose

Also Available:



8" Diagonal Cutting Pliers
48-22-6508

Model #	Description
48-22-6106	6" Comfort Grip Diagonal Cutting Pliers
48-22-6107	7" Comfort Grip Diagonal Cutting Pliers
48-22-6108	8" Comfort Grip Diagonal Cutting Pliers
48-22-6508	8" Diagonal Cutting Pliers

COMBINATION & MULTI-FUNCTION PLIERS

6IN1 COMBINATION PLIERS

6IN1

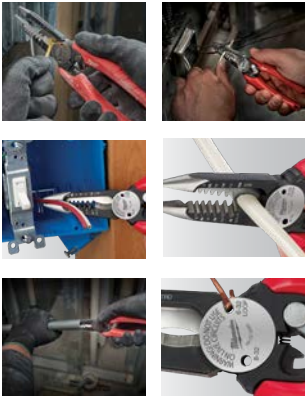
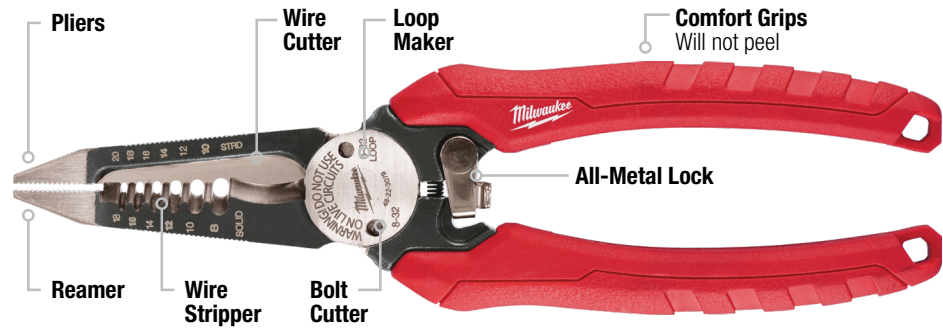

Model #	Description	Wire Stripper
48-22-3079	6IN1 Comfort Grip Combination Pliers	8-18 AWG Solid, 10-20 AWG Stranded

MULTI-FUNCTION PLIERS

FAST, ONE-HANDED OPERATION

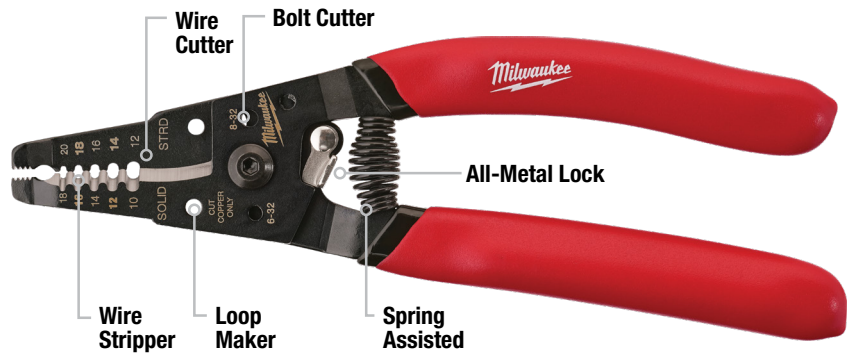

Model #	Description	Wire Stripper
48-22-6109	Wire Stripper	10-18 AWG Solid, 12-20 AWG Stranded
48-22-6579	Multi-Purpose Wire Stripper with Crimper	10-20 AWG Solid, 12-22 AWG Stranded

IRONWORKER'S PLIERS

UP TO **2X MORE CUTS**

IRON-CARBIDE EDGE

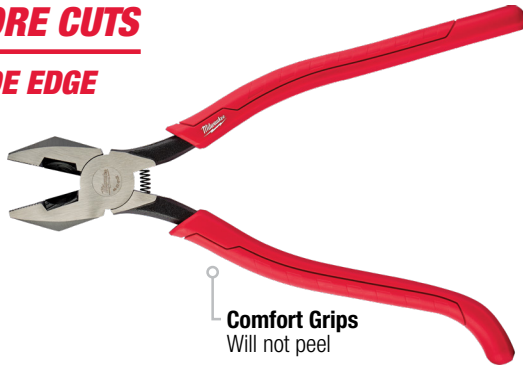

Comfort Grips
Will not peel



For Twisting & Cutting Rebar Ties

Model #	Description
48-22-6102	Ironworker's Pliers

CRIMPING PLIERS

UP TO **2X CRIMPING FORCE**

Reaming Head Wire Cutter



Comfort Grips
Will not peel



Crimper for Insulated & Non-Insulated Terminals

Model #	Description
48-22-6103	Crimping Pliers

CABLE CUTTING PLIERS

CLEAN CUTS



Comfort Grips
Will not peel



Cuts up to 2/0 Cu, 4/0 Al

Model #	Description
48-22-6104	Cable Cutting Pliers

PVC / OIL FILTER PLIERS

3-1/2" JAW CAPACITY



Comfort Grips
Will not peel



Model #	Description
48-22-6321	PVC / Oil Filter Pliers

NIPPING PLIERS

CURVED HEAD. PROTECTS SURFACES.



Comfort Grips
Will not peel

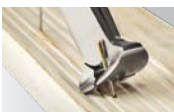

Blades Will Not Mar Surfaces

Model #	Description
48-22-6407	7" Nipping Pliers

FENCING PLIERS

FORGED STRENGTH

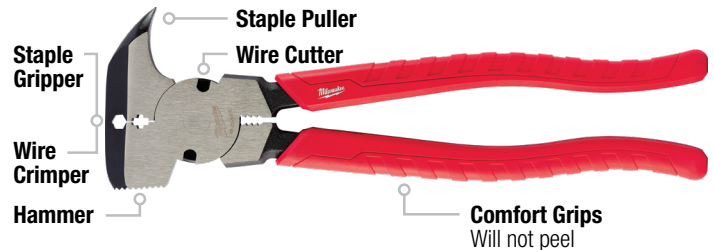

Comfort Grips
Will not peel

Staple Gripper
Wire Cutter
Wire Crimper
Hammer



Wire Puller

Model #	Description
48-22-6410	Fencing Pliers

TORQUE LOCK™ PLIERS, C-CLAMPS & SPECIALTY

TORQUE LOCK™ FASTER SET-UP



LOCKING PLIERS WITH MAX BITE™

MAX BITE™ 3X GRIPPING FORCE



CHROME
Chrome plated rust protection



GRIPPED
Rubber overmold

Model #	Description
48-22-3607	7" TORQUE LOCK™ MAX BITE™ Curved Jaw Locking Pliers
48-22-3610	10" TORQUE LOCK™ MAX BITE™ Curved Jaw Locking Pliers
48-22-3702	2 Pc 7" & 10" TORQUE LOCK™ MAX BITE™ Curved Jaw Locking Pliers

Model #	Description
48-22-3710	10" TORQUE LOCK™ MAX BITE™ Curved Jaw Locking Pliers With Grip
48-22-3707	7" TORQUE LOCK™ MAX BITE™ Curved Jaw Locking Pliers With Grip

LOCKING PLIERS



CURVED JAW
Maximizes pressure points for any bolt, nut or locking tool application



STRAIGHT JAW
Maximizes contact points on jobsite work surfaces



LONG NOSE
Best for long reach applications

Model #	Description
48-22-3405	5" TORQUE LOCK™ Curved Jaw Locking Pliers with Grip
48-22-3407	7" TORQUE LOCK™ Curved Jaw Locking Pliers with Grip
48-22-3410	10" TORQUE LOCK™ Curved Jaw Locking Pliers with Grip
48-22-3406	6" TORQUE LOCK™ Long Nose Locking Pliers with Grip
48-22-3409	9" TORQUE LOCK™ Long Nose Locking Pliers with Grip
48-22-3807	7" TORQUE LOCK™ Straight Jaw Locking Pliers with Grip
48-22-3810	10" TORQUE LOCK™ Straight Jaw Locking Pliers with Grip
48-22-3402	2 Pc 7" & 10" TORQUE LOCK™ Curved Jaw Locking Pliers with Grip Set
48-22-3602	2 Pc. 10" Curved Jaw & 6" Long Nose TORQUE LOCK™ Locking Pliers Set
48-22-3423	4" TORQUE LOCK™ Curved Jaw Locking Pliers

Model #	Description
48-22-3422	5" TORQUE LOCK™ Curved Jaw Locking Pliers
48-22-3421	7" TORQUE LOCK™ Curved Jaw Locking Pliers
48-22-3420	10" TORQUE LOCK™ Curved Jaw Locking Pliers
48-22-3504	4" TORQUE LOCK™ Long Nose Locking Pliers
48-22-3506	6" TORQUE LOCK™ Long Nose Locking Pliers
48-22-3507	7" TORQUE LOCK™ Straight Jaw Locking Pliers
48-22-3509	9" TORQUE LOCK™ Long Nose Locking Pliers
48-22-3510	10" TORQUE LOCK™ Straight Jaw Locking Pliers
48-22-3541	12" TORQUE LOCK™ Large Jaw Locking Pliers

C-CLAMPS & SPECIALTY

STANDARD JAW C-CLAMP

Greater clamping versatility on a variety of shapes and surfaces



SWIVEL JAW C-CLAMP

Pads provide surface stabilization and protect work surfaces from damage



Model #	Description
48-22-3521	11" TORQUE LOCK™ Swivel Jaw Locking C-Clamp
48-22-3522	6" TORQUE LOCK™ Swivel Jaw Locking C-Clamp
48-22-3531	11" TORQUE LOCK™ Locking C-Clamp
48-22-3532	6" TORQUE LOCK™ Locking C-Clamp
48-22-3520	18" TORQUE LOCK™ Swivel Jaw Locking C-Clamp
48-22-3529	18" TORQUE LOCK™ Deep Reach Locking C-Clamp
48-22-3530	18" TORQUE LOCK™ Locking C-Clamp

Model #	Description
48-22-3540	8" TORQUE LOCK™ Locking Seamer
48-22-3542	9" TORQUE LOCK™ Locking Chain Wrench
48-22-3543	9" TORQUE LOCK™ Locking Welding Clamp
48-22-3523	9" TORQUE LOCK™ Deep Reach Swivel Jaw Locking C-Clamp
48-22-3533	9" TORQUE LOCK™ Deep Reach Locking C-Clamp
48-22-3631	11" TORQUE LOCK™ Locking C-Clamp
48-22-3632	6" TORQUE LOCK™ Locking C-Clamp

2IN1 LINEMAN'S INSULATED RATCHETING BOX WRENCH

**DURABLE, FORGED STEEL.
1000V INSULATED.**



9/16" and 3/4" Twelve Point Sockets

Model #	Description
48-22-9211	Lineman's 2in1 Insulated Ratcheting Box Wrench

4IN1 LINEMAN'S INSULATED RATCHETING BOX WRENCH

**DURABLE, FORGED STEEL.
1000V INSULATED.**

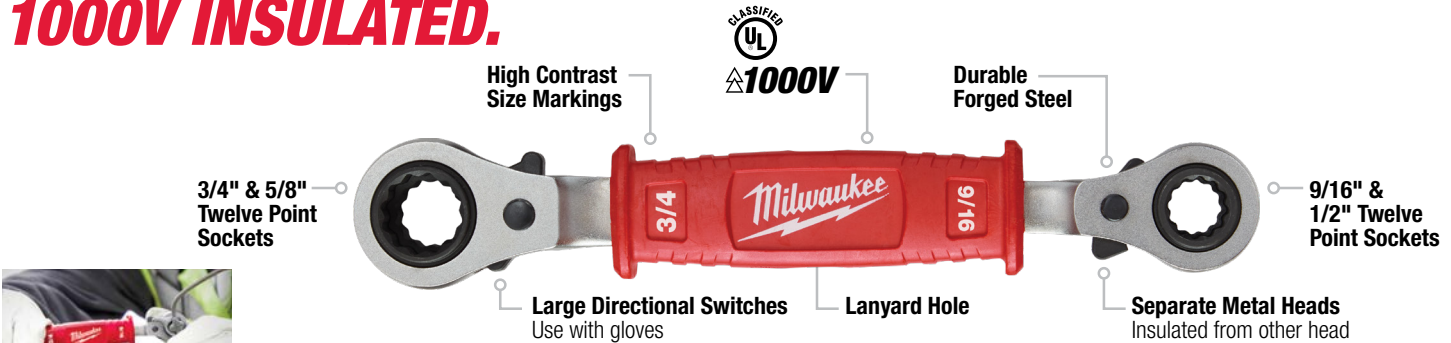

Ergonomic Handle

Model #	Description
48-22-9212	Lineman's 4in1 Insulated Ratcheting Box Wrench

POWER UTILITY WRENCH

**MOST DURABLE RATCHET.
BUILT IN HAMMER.**

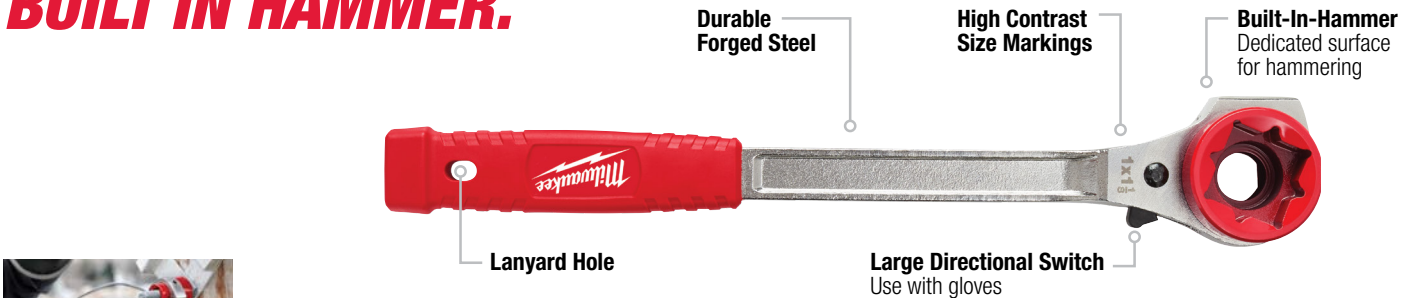

Durable Forged Steel

Model #	Description
48-22-9213	Lineman's High-Leverage Ratcheting Wrench with Smooth Strike Face

POWER UTILITY WRENCH & PIPE WRENCHES

POWER UTILITY WRENCH

**MOST DURABLE RATCHET.
BUILT IN HAMMER.**

3/4" & 1-1/8" Square

Built-In-Hammer
Dedicated surface for hammering

Durable Forged Steel

Laser Etched Size Markings

9/16" & 3/4" Twelve Point Sockets

Lanyard Hole



Large Directional Switches

Model #	Description
48-22-9216	5in1 Lineman's Ratcheting Wrench with Smooth Strike Face

CHEATER ADAPTABLE PIPE WRENCH

3 LENGTH DESIGN



Dual Coil Spring Design
Increased durability and life



OVERBITE JAW™
Largest Gripping Surface

Lanyard Hole

Threaded Fit & Security



Model #	Description	Material	Max Jaw Capacity
48-22-7314	CHEATER Adaptable Pipe Wrench	Steel	2-1/2"

10L ALUMINUM PIPE WRENCH WITH POWERLENGTH™ HANDLE

**BETTER ACCESS.
MAXIMUM LEVERAGE.**



Lanyard Hole



Model #	Description	Material	Max Jaw Capacity
48-22-7313	10L Aluminum Pipe Wrench w/POWERLENGTH™ Handle	Aluminum	1-1/2"

STEEL & ALUMINUM PIPE WRENCHES

LARGEST GRIP SURFACE



Steel



Aluminum

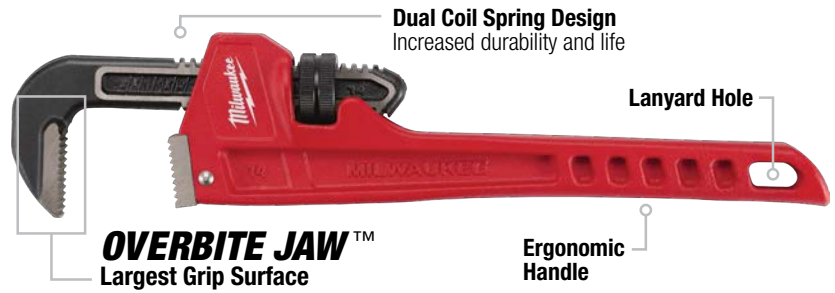

Model #	Description	Length	Material	Max Jaw Capacity
48-22-7106	6" Steel Pipe Wrench	6"	Steel	3/4"
48-22-7108	8" Steel Pipe Wrench	8"	Steel	1"
48-22-7110	10" Steel Pipe Wrench	10"	Steel	1-1/2"
48-22-7112	12" Steel Pipe Wrench	12"	Steel	2"
48-22-7114	14" Steel Pipe Wrench	14"	Steel	2"
48-22-7118	18" Steel Pipe Wrench	18"	Steel	2-1/2"
48-22-7124	24" Steel Pipe Wrench	24"	Steel	3"
48-22-7136	36" Steel Pipe Wrench	36"	Steel	5"

Model #	Description	Length	Material	Max Jaw Capacity
48-22-7148	48" Steel Pipe Wrench	48"	Steel	6"
48-22-7160	60" Steel Pipe Wrench	60"	Steel	8"
48-22-7210	10" Aluminum Pipe Wrench	10"	Aluminum	1-1/2"
48-22-7212	12" Aluminum Pipe Wrench	12"	Aluminum	2"
48-22-7214	14" Aluminum Pipe Wrench	14"	Aluminum	2"
48-22-7218	18" Aluminum Pipe Wrench	18"	Aluminum	2-1/2"
48-22-7224	24" Aluminum Pipe Wrench	24"	Aluminum	3"
48-22-7236	36" Aluminum Pipe Wrench	36"	Aluminum	5"
48-22-7248	48" Aluminum Pipe Wrench	48"	Aluminum	6"

STEEL OFFSET HEX PIPE WRENCH

SMOOTH JAW WON'T MAR SURFACES



Protects Chrome Surfaces



Model #	Description	Material	Max Jaw Capacity
48-22-7171	Steel Offset Hex Pipe Wrench	Steel	2-5/8"

STEEL SMOOTH JAW PIPE WRENCH

SMOOTH JAW PROTECTS SURFACES



Protects Chrome Surfaces



Model #	Description	Material	Max Jaw Capacity
48-22-7186	12" Steel Smooth Jaw Pipe Wrench	Steel	2-5/8"

PIPE WRENCHES & MULTI BIT DRIVERS

ALUMINUM OFFSET HEX PIPE WRENCHES

BETTER ACCESS



Offset Head

Model #	Description	Material	Max Jaw Capacity
48-22-7184	14" Aluminum Offset Pipe Wrench	Aluminum	2"
48-22-7185	18" Aluminum Offset Pipe Wrench	Aluminum	2"
48-22-7182	24" Aluminum Offset Pipe Wrench	Aluminum	3"

9IN1 MULTI-BIT / KEY DRIVERS

9IN1

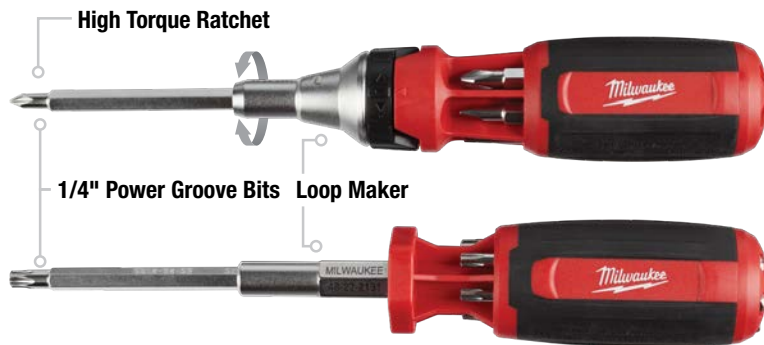

Power Tool Compatibility



In-Handle Storage

Model #	Description	Nut Drivers	Bit Types
48-22-2131	9in1 Multi-Bit Driver w/ ECX™	1/4"	P#1, P#2, SL 3/16", SL 1/4", SQ#2, ECX™#1, ECX™#2
48-22-2132	9in1 Square Multi-Bit Driver	1/4"	P#1, P#2, SL 3/16", SL 1/4", SQ#1, SQ#2, SQ#3
48-22-2331	9in1 Ratchet Multi-Bit Driver w/ ECX™	1/4"	P#1, P#2, SL 3/16", SL 1/4", SQ#2, ECX™#1, ECX™#2
48-22-2322	9in1 Ratchet Multi-Bit Driver w/ Square	1/4"	P#1, P#2, SL 3/16", SL 1/4", SQ#1, SQ#2, SQ#3
48-22-2133	9in1 TORX® Key Driver	1/4"	T8, T10, T15, T20, T25, T27, T30
48-22-2134	9in1 SAE Hex Key Driver	1/4"	7/64", 1/8", 9/64", 5/32", 3/16", 7/32", 1/4"
48-22-2136	9in1 Metric Hex Key Driver	1/4"	1.5mm, 2mm, 2.5mm, 3mm, 4mm, 5mm, 6mm
48-22-2110	4 Pc Replacement Bit Set		P#1, P#2, SL 3/16", SL 1/4", SQ #1, SQ#1, ECX™#1

8IN1 COMPACT MULTI-BIT DRIVERS

8IN1



Power Tool Compatibility



In-Handle Storage

Model #	Description	Nut Drivers	Bit Types
48-22-2130	Compact 8in1 Multi-Bit Driver	1/4"	P#1, P#2, SL 3/16", SL 1/4", SQ#1, SQ#2, T15
48-22-2330	Compact 8in1 Ratchet Multi-Bit Driver	1/4"	P#1, P#2, SL 3/16", SL 1/4", SQ#1, SQ#2, T15

ADJUSTABLE WRENCHES

**JAWS WON'T
BACK OFF**
Proprietary Screw

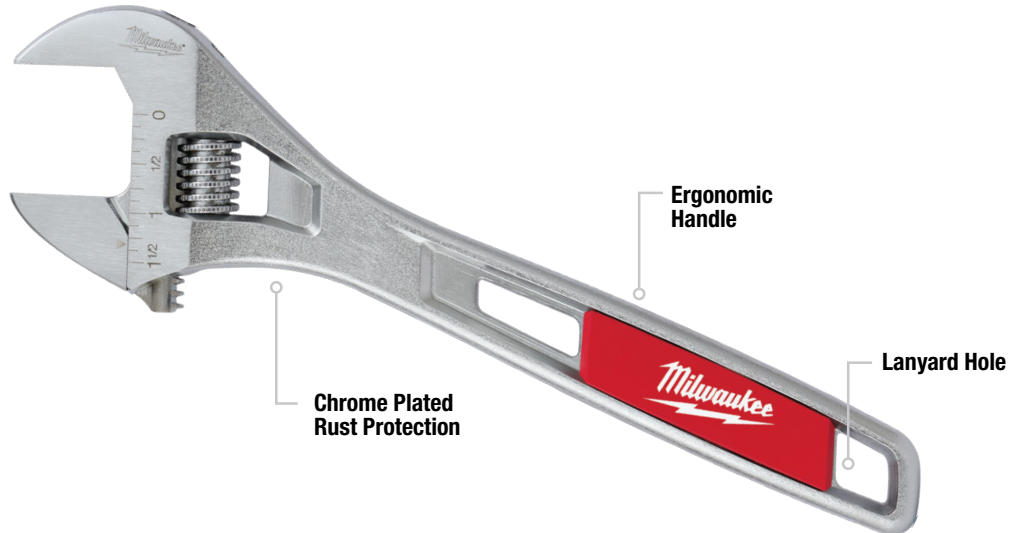
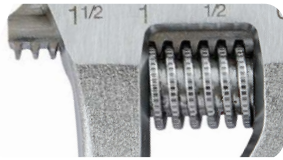

Perfectly Parallel Jaws

Model #	Description
48-22-7400	2 Pc 6" & 10" Adjustable Wrench Set
48-22-7406	6" Adjustable Wrench
48-22-7408	8" Adjustable Wrench
48-22-7410	10" Adjustable Wrench
48-22-7412	12" Adjustable Wrench
48-22-7415	15" Adjustable Wrench
48-22-7508	8" Wide Jaw Adjustable Wrench

BASIN WRENCHES

**EASIEST
SWAP-OUTS**



Ratchet-Ready
Less jaw readjusting



Screwdriver-Ready
Up to 2X breakaway torque

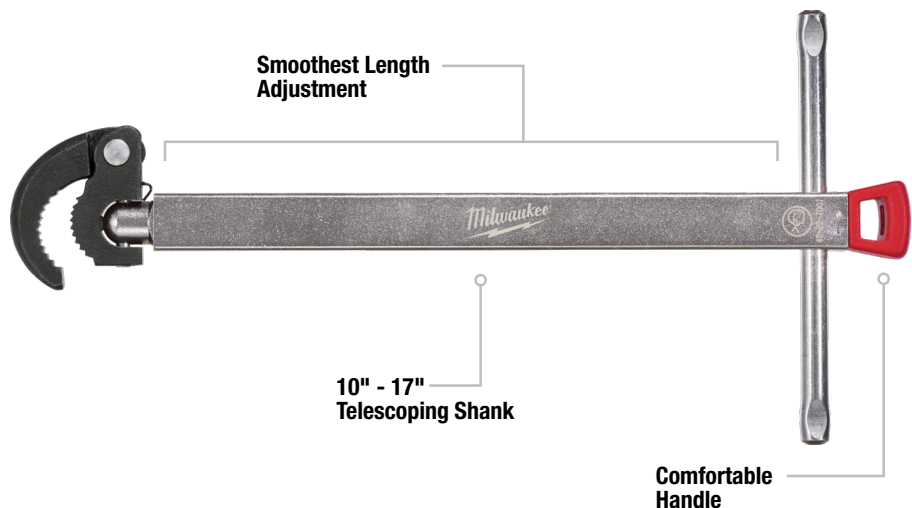

Model #	Description
48-22-7001	1-1/4" Basin Wrench
48-22-7002	2-1/2" Basin Wrench

CONTRACTOR RATCHET & SOCKET SETS

**VERSATILE DESIGN.
BETTER ACCESS.**

SAE **METRIC**



FOUR FLAT™ SIDES
Anti-Roll, Wrench-Ready.

Slim Design



Pivoting Head

Model #	Description
48-22-9000	12 Pc 3/8" SAE Contractor Ratchet & Socket Set with FOUR FLAT™ Sides
48-22-9001	12 Pc 3/8" Metric Contractor Ratchet & Socket Set with FOUR FLAT™ Sides

MECHANICS RATCHET & SOCKET SETS

**MOST VERSATILE SOCKETS.
ANTI-ROLL, WRENCH-READY.**

SAE **METRIC**

Stamped Sizes
Better visibility



Anti-Roll

Wrench-Ready



90° Tooth Design

Slim Design
Access tight spaces

4° ARC SWING



FOUR FLAT™ SIDES

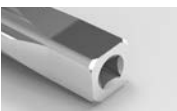

Anti-Roll



Wrench-Ready

Model #	Description
48-22-9404	26 Pc 1/4" Drive SAE Ratchet & Socket Set with FOUR FLAT™ Sides
48-22-9408	28 Pc 3/8" Drive SAE Ratchet & Socket Set with FOUR FLAT™ Sides
48-22-9410	22 Pc 1/2" Drive SAE Ratchet & Socket Set with FOUR FLAT™ Sides
48-22-9504	28 Pc 1/4" Drive Metric Ratchet & Socket Set with FOUR FLAT™ Sides
48-22-9508	32 Pc 3/8" Drive Metric Ratchet & Socket Set with FOUR FLAT™ Sides
48-22-9510	28 Pc 1/2" Drive Metric Ratchet & Socket Set with FOUR FLAT™ Sides
48-22-9004	50 Pc 1/4" Drive Metric & SAE Ratchet & Socket Set with FOUR FLAT™ Sides
48-22-9008	56 Pc 3/8" Drive Metric & SAE Ratchet & Socket Set with FOUR FLAT™ Sides
48-22-9010	47 Pc 1/2" Drive Metric & SAE Ratchet & Socket Set with FOUR FLAT™ Sides

RATCHETING COMBINATION WRENCHES

**BETTER ACCESS.
LONGEST LIFE.**

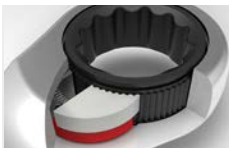
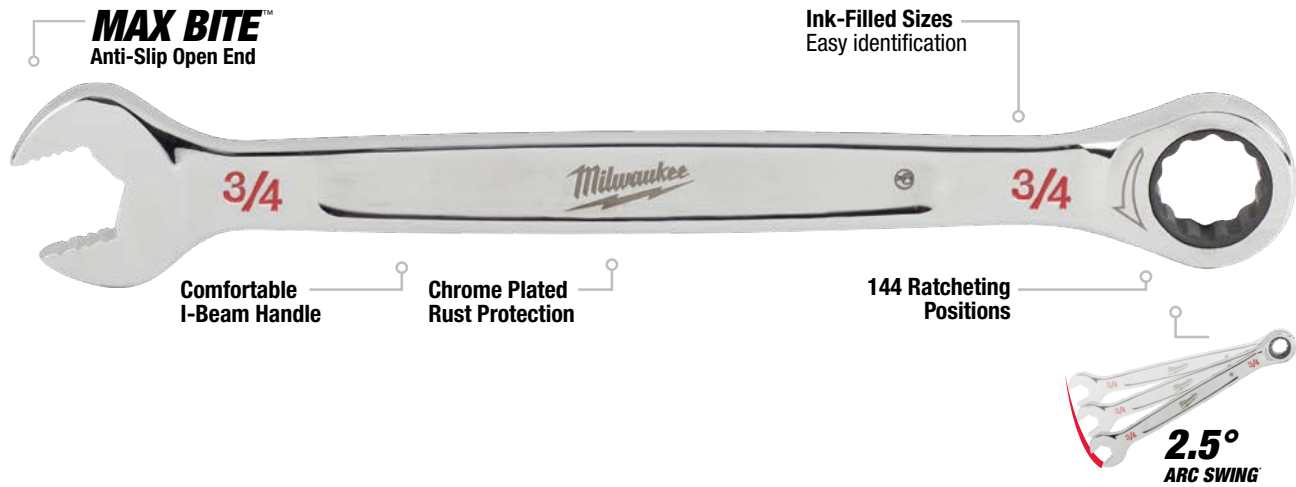

Durable Double Stacked Pawls

Model #	Description	Included Sizes
48-22-9406	7 Pc SAE Ratcheting Combination Wrench Set	3/8", 7/16", 1/2", 9/16", 5/8", 11/16", 3/4"
48-22-9506	7 Pc Metric Ratcheting Combination Wrench Set	8mm, 10mm, 12mm, 13mm, 14mm, 15mm, 17mm
48-22-9416	15 Pc SAE Ratcheting Combination Wrench Set	1/4", 9/32", 5/16", 11/32", 3/8", 7/16", 1/2", 9/16", 5/8", 11/16", 3/4", 13/16", 7/8", 15/16", 1"
48-22-9516	15 Pc Metric Ratcheting Combination Wrench Set	8mm, 9mm, 10mm, 11mm, 12mm, 13mm, 14mm, 15mm, 16mm, 17mm, 18mm, 19mm, 20mm, 21mm, 22mm

Model #	Description
45-96-9208	1/4" SAE Ratcheting Combination Wrench
45-96-9209	9/32" SAE Ratcheting Combination Wrench
45-96-9210	5/16" SAE Ratcheting Combo Wrench
45-96-9211	11/32" SAE Ratcheting Combination Wrench
45-96-9212	3/8" SAE Ratcheting Combination Wrench
45-96-9214	7/16" SAE Ratcheting Combination Wrench
45-96-9216	1/2" SAE Ratcheting Combination Wrench
45-96-9218	9/16" SAE Ratcheting Combination Wrench
45-96-9220	5/8" SAE Ratcheting Combination Wrench
45-96-9222	11/16" SAE Ratcheting Combination Wrench
45-96-9224	3/4" SAE Ratcheting Combination Wrench
45-96-9226	13/16" SAE Ratcheting Combination Wrench
45-96-9228	7/8" SAE Ratcheting Combination Wrench
45-96-9230	15/16" SAE Ratcheting Combo Wrench
45-96-9232	1" SAE Ratcheting Combination Wrench

Model #	Description
45-96-9308	8mm Metric Ratcheting Combination Wrench
45-96-9309	9mm Metric Ratcheting Combination Wrench
45-96-9310	10mm Metric Ratcheting Combination Wrench
45-96-9311	11mm Metric Ratcheting Combination Wrench
45-96-9312	12mm Metric Ratcheting Combination Wrench
45-96-9313	13mm Metric Ratcheting Combination Wrench
45-96-9314	14mm Metric Ratcheting Combination Wrench
45-96-9315	15mm Metric Ratcheting Combination Wrench
45-96-9316	16mm Metric Ratcheting Combination Wrench
45-96-9317	17mm Metric Ratcheting Combination Wrench
45-96-9318	18mm Metric Ratcheting Combination Wrench
45-96-9319	19mm Metric Ratcheting Combination Wrench
45-96-9320	20mm Metric Ratcheting Combination Wrench
45-96-9321	21mm Metric Ratcheting Combination Wrench
45-96-9322	22mm Metric Ratcheting Combination Wrench

COMBINATION WRENCHES

COMBINATION WRENCHES

UP TO
25% MORE TORQUE

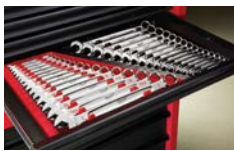

Innovative Storage Solution

Model #	Description	Included Sizes
48-22-9407	7 Pc SAE Combination Wrench Set	3/8", 7/16", 1/2", 9/16", 5/8", 11/16", 3/4"
48-22-9507	7 Pc Metric Combination Wrench Set	8mm, 10mm, 12mm, 13mm, 14mm, 15mm, 17mm
48-22-9415	15 Pc SAE Combination Wrench Set	1/4", 9/32", 5/16", 11/32", 3/8", 7/16", 1/2", 9/16", 5/8", 11/16", 3/4", 13/16", 7/8", 15/16", 1"
48-22-9515	15 Pc Metric Combination Wrench Set	8mm, 9mm, 10mm, 11mm, 12mm, 13mm, 14mm, 15mm, 16mm, 17mm, 18mm, 19mm, 20mm, 21mm, 22mm

Model #	Description
45-96-9408	1/4" SAE Combination Wrench
45-96-9409	9/32" SAE Combination Wrench
45-96-9410	5/16" SAE Combo Wrench
45-96-9411	11/32" SAE Combination Wrench
45-96-9412	3/8" SAE Combination Wrench
45-96-9414	7/16" SAE Combination Wrench
45-96-9416	1/2" SAE Combination Wrench
45-96-9418	9/16" SAE Combination Wrench
45-96-9420	5/8" SAE Combination Wrench
45-96-9422	11/16" SAE Combination Wrench
45-96-9424	3/4" SAE Combination Wrench
45-96-9426	13/16" SAE Combination Wrench
45-96-9428	7/8" SAE Combination Wrench
45-96-9430	15/16" SAE Combo Wrench
45-96-9432	1" SAE Combination Wrench

Model #	Description
45-96-9508	8mm Metric Combination Wrench
45-96-9509	9mm Metric Combination Wrench
45-96-9510	10mm Metric Combination Wrench
45-96-9511	11mm Metric Combination Wrench
45-96-9512	12mm Metric Combination Wrench
45-96-9513	13mm Metric Combination Wrench
45-96-9514	14mm Metric Combination Wrench
45-96-9515	15mm Metric Combination Wrench
45-96-9516	16mm Metric Combination Wrench
45-96-9517	17mm Metric Combination Wrench
45-96-9518	18mm Metric Combination Wrench
45-96-9519	19mm Metric Combination Wrench
45-96-9520	20mm Metric Combination Wrench
45-96-9521	21mm Metric Combination Wrench
45-96-9522	22mm Metric Combination Wrench

SOCKETS WITH FOUR FLAT™ SIDES

MOST VERSATILE SOCKETS. ANTI-ROLL, WRENCH-READY.



SAE **METRIC**

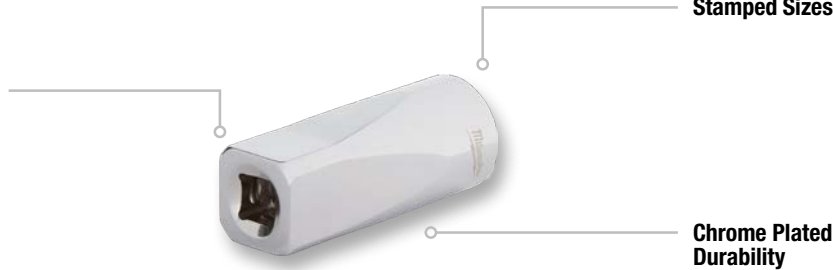
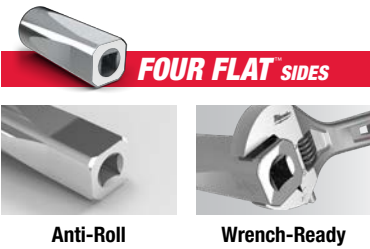

Model #	Description
45-34-9001	1/4" Drive 3/16" SAE Socket
45-34-9002	1/4" Drive 7/32" SAE Socket
45-34-9003	1/4" Drive 1/4" SAE Socket
45-34-9004	1/4" Drive 9/32" SAE Socket
45-34-9005	1/4" Drive 5/16" SAE Socket
45-34-9006	1/4" Drive 11/32" SAE Socket
45-34-9007	1/4" Drive 3/8" SAE Socket
45-34-9008	1/4" Drive 7/16" SAE Socket
45-34-9009	1/4" Drive 1/2" SAE Socket
45-34-9010	1/4" Drive 9/16" SAE Socket
45-34-9011	1/4" Drive 5/32" SAE Deep Socket
45-34-9012	1/4" Drive 3/16" SAE Deep Socket
45-34-9013	1/4" Drive 7/32" SAE Deep Socket
45-34-9014	1/4" Drive 1/4" SAE Deep Socket
45-34-9015	1/4" Drive 9/32" SAE Deep Socket
45-34-9016	1/4" Drive 5/16" SAE Deep Socket
45-34-9017	1/4" Drive 11/32" SAE Deep Socket
45-34-9018	1/4" Drive 3/8" SAE Deep Socket
45-34-9019	1/4" Drive 7/16" SAE Deep Socket
45-34-9020	1/4" Drive 1/2" SAE Deep Socket
45-34-9021	1/4" Drive 9/16" SAE Deep Socket
45-34-9060	3/8" Drive 1/4" SAE Socket
45-34-9061	3/8" Drive 5/16" SAE Socket
45-34-9062	3/8" Drive 3/8" SAE Socket
45-34-9063	3/8" Drive 7/16" SAE Socket
45-34-9064	3/8" Drive 1/2" SAE Socket
45-34-9065	3/8" Drive 9/16" SAE Socket
45-34-9066	3/8" Drive 5/8" SAE Socket
45-34-9067	3/8" Drive 11/16" SAE Socket
45-34-9068	3/8" Drive 3/4" SAE Socket
45-34-9069	3/8" Drive 13/16" SAE Socket
45-34-9070	3/8" Drive 7/8" SAE Socket
45-34-9071	3/8" Drive 15/16" SAE Socket
45-34-9072	3/8" Drive 1" SAE Socket
45-34-9073	3/8" Drive 1/4" SAE Deep Socket
45-34-3125	3/8" Drive 5/16" SAE Deep Socket

Model #	Description
45-34-3750	3/8" Drive 3/8" SAE Deep Socket
45-34-4375	3/8" Drive 7/16" SAE Deep Socket
45-35-5000	3/8" Drive 1/2" SAE Deep Socket
45-34-5625	3/8" Drive 9/16" SAE Deep Socket
45-34-6250	3/8" Drive 5/8" SAE Deep Socket
45-34-6875	3/8" Drive 11/16" SAE Deep Socket
45-34-7500	3/8" Drive 3/4" SAE Deep Socket
45-34-9074	3/8" Drive 13/16" SAE Deep Socket
45-34-9075	3/8" Drive 7/8" SAE Deep Socket
45-34-9100	1/2" Drive 1/2" SAE Socket
45-34-9101	1/2" Drive 9/16" SAE Socket
45-34-9102	1/2" Drive 5/8" SAE Socket
45-34-9103	1/2" Drive 11/16 SAE Socket
45-34-9104	1/2" Drive 3/4" SAE Socket
45-34-9105	1/2" Drive 13/16" SAE Socket
45-34-9106	1/2" Drive 7/8" SAE Socket
45-34-9107	1/2" Drive 15/16" SAE Socket
45-34-9108	1/2" Drive 1" SAE Socket
45-34-9109	1/2" Drive 1-1/16" SAE Socket
45-34-9110	1/2" Drive 1-1/8" SAE Socket
45-34-9126	1/2" Drive 1/2" SAE Deep Socket
45-34-9127	1/2" Drive 9/16" SAE Deep Socket
45-34-9128	1/2" Drive 5/8" SAE Deep Socket
45-34-9129	1/2" Drive 11/16" SAE Deep Socket
45-34-9130	1/2" Drive 3/4" SAE Deep Socket
45-34-9131	1/2" Drive 13/16" SAE Deep Socket
45-34-9132	1/2" Drive 7/8" SAE Deep Socket
45-34-9133	1/2" Drive 15/16" SAE Deep Socket
45-34-9085	3/8" Drive 15mm Metric Socket
45-34-9086	3/8" Drive 16mm Metric Socket
45-34-9087	3/8" Drive 17mm Metric Socket
45-34-9088	3/8" Drive 18mm Metric Socket
45-34-9089	3/8" Drive 19mm Metric Socket
45-34-9090	3/8" Drive 6mm Metric Deep Socket
45-34-9091	3/8" Drive 7mm Metric Deep Socket
45-34-9092	3/8" Drive 8mm Metric Deep Socket

Model #	Description
45-34-9093	3/8" Drive 9mm Metric Deep Socket
45-34-0010	3/8" Drive 10mm Metric Deep Socket
45-34-9094	3/8" Drive 11mm Metric Deep Socket
45-34-0012	3/8" Drive 12mm Metric Deep Socket
45-34-0013	3/8" Drive 13mm Metric Deep Socket
45-34-0014	3/8" Drive 14mm Metric Deep Socket
45-34-0015	3/8" Drive 15mm Metric Deep Socket
45-34-9095	3/8" Drive 16mm Metric Deep Socket
45-34-0117	3/8" Drive 17mm Metric Deep Socket
45-34-0118	3/8" Drive 18mm Metric Deep Socket
45-34-0119	3/8" Drive 19mm Metric Deep Socket
45-34-9111	1/2" Drive 10mm Metric Socket
45-34-9112	1/2" Drive 11mm Metric Socket
45-34-9113	1/2" Drive 12mm Metric Socket
45-34-9114	1/2" Drive 13mm Metric Socket
45-34-9115	1/2" Drive 14mm Metric Socket
45-34-9116	1/2" Drive 15mm Metric Socket
45-34-9117	1/2" Drive 16mm Metric Socket
45-34-9118	1/2" Drive 17mm Metric Socket
45-34-9119	1/2" Drive 18mm Metric Socket
45-34-9120	1/2" Drive 19mm Metric Socket
45-34-9121	1/2" Drive 20mm Metric Socket
45-34-9122	1/2" Drive 21mm Metric Socket
45-34-9123	1/2" Drive 22mm Metric Socket
45-34-9124	1/2" Drive 23mm Metric Socket
45-34-9125	1/2" Drive 24mm Metric Socket
45-34-9134	1/2" Drive 10mm Metric Deep Socket
45-34-9135	1/2" Drive 11mm Metric Deep Socket
45-34-9136	1/2" Drive 12mm Metric Deep Socket
45-34-9137	1/2" Drive 13mm Metric Deep Socket
45-34-9138	1/2" Drive 14mm Metric Deep Socket
45-34-9139	1/2" Drive 15mm Metric Deep Socket
45-34-9140	1/2" Drive 16mm Metric Deep Socket
45-34-9141	1/2" Drive 17mm Metric Deep Socket
45-34-9142	1/2" Drive 18mm Metric Deep Socket
45-34-9143	1/2" Drive 19mm Metric Deep Socket

DRIVE RATCHETS, BREAKER BARS & SOCKET ACCESSORIES

RATCHETS

BETTER ACCESS



Slim Design
Access tight places

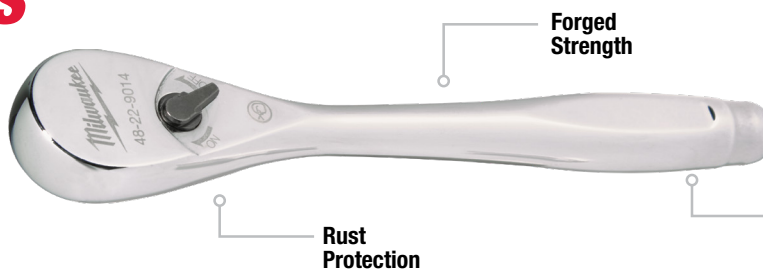

4° ARC SWING

Model #	Description
48-22-9014	1/4" Drive Ratchet
48-22-9038	3/8" Drive Ratchet

Model #	Description
48-22-9012	1/2" Drive Ratchet

BREAKER BARS

BETTER LEVERAGE



180° Pivoting Head

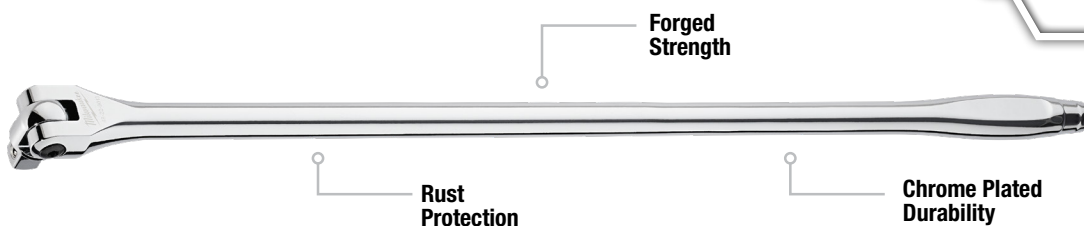

Model #	Description
48-22-9011	1/2" Drive 15" Breaker Bar

Model #	Description
48-22-9013	1/2" Drive 24" Breaker Bar

SOCKET ACCESSORIES



Extended Reach

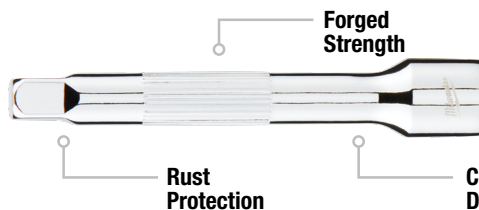

Model #	Description
43-24-9100	1/4" Drive 3" Extension
43-24-9101	1/4" Drive 6" Extension
42-04-9102	1/4" Drive Universal Joint
43-24-9102	3/8" Drive 3" Extension

Model #	Description
43-24-0006	3/8" Drive 6" Extension
42-04-9103	3/8" Drive Universal Joint
43-24-9103	1/2" Drive 3" Extension
43-24-9104	1/2" Drive 5" Extension

HOOK AND PICK SET

UP TO
50% MORE DURABLE

ALL-METAL CORE



Easy Access Storage Tray

Model #	Description	Includes
48-22-9215	4 Pc Hook and Pick Set	Straight Pick, Offset Hook, Hook, 90° Hook

PRY BARS

UP TO
40% MORE PRYING STRENGTH

I-BEAM DESIGN

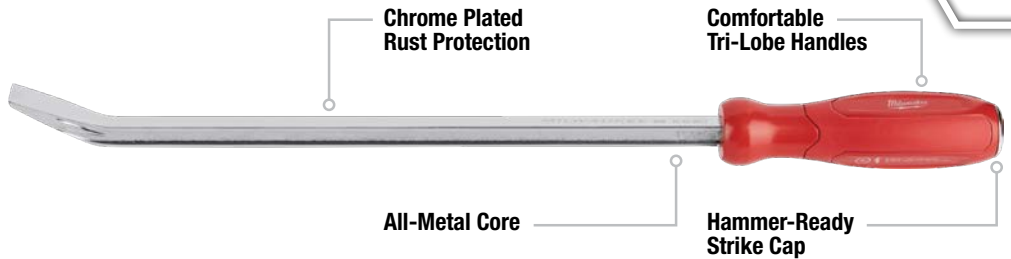

Easy Access Storage Tray

Model #	Description	Included Lengths
48-22-9214	4 Pc Pry Bar Set	8", 12", 18", 24"

11IN1 MULTI-BIT DRIVERS

11IN1

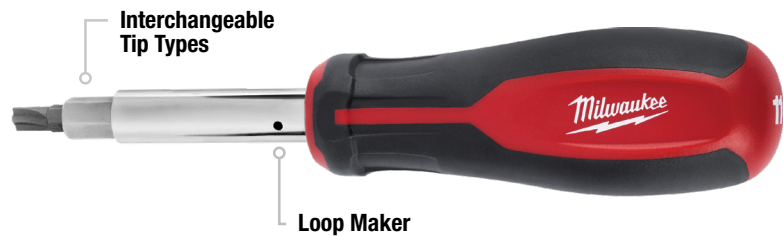

Comfortable Tri-Lobe Handle

Model #	Description	Nut Drivers	Bit Types
48-22-2760	11in1 Multi-Bit Driver w/ ECX™	1/4", 5/16", 3/8"	P#1, P#2, SL 3/16", SL 1/4", SQ#1, SQ#2, ECX™#1, ECX™#2
48-22-2761	11in1 Multi-Bit Driver w/ TORX®	1/4", 5/16", 3/8"	P#1, P#2, SL 3/16", SL 1/4", SQ#1, SQ#2, T10, T15

13IN1 CUSHION-GRIP SCREWDRIVERS

13IN1



ECX™ Bit



Schrader® Valve Core Remover



Loop Maker



Wrench-Ready Bolster
Increased torque



Cushion Grip
Anti-Peel design

Model #	Description	Nut Drivers	Bit Types
48-22-2880	13in1 Cushion-Grip Screwdriver with ECX™ Bit	1/4", 5/16", 3/8", 1/2"	P#1, P#2, SL 3/16", SL1/4", SQ#1, SQ#2, ECX™#1, ECX™#2
48-22-2881	13in1 Cushion-Grip Screwdriver with Schrader® Bit	1/4", 5/16", 3/8", 1/2"	P#1, P#2, SL 3/16", SL1/4", SQ#1, SQ#2, Std Schrader®, Large Schrader®

SCREWDRIVERS

HIGH-LEVERAGE HANDLE. MAGNETIC TIP.



Also Available:



Bottle Opener
48-22-2700



Comfortable Tri-Lobe Handle

Model #	Description	Bit Types
48-22-2702	2 Pc Demolition Screwdriver Set	P#2, SL 5/16"
48-22-2706	6 Pc Screwdriver Set	P#1, P#2, SL 3/16", SL 1/4", SL 5/16"
48-22-2708	8 Pc Screwdriver Set w/ ECX™	P#1, P#2, SL 3/16", SL 1/4", SL 5/16", ECX™#1, ECX™#2
48-22-2710	10 Pc Screwdriver Set	P#1, P#2, SL 3/16", SL 1/4", SL 5/16", SQ#1, SQ#2
48-22-2718	8 Pc Screwdriver Set w/ Square	P#1, P#2, SL 3/16", SL 1/4", SL 5/16", SQ#1, SQ#2
48-22-2700	Bottle Opener	

CUSHION-GRIP SCREWDRIVERS

MOST DURABLE HANDLE. PRECISION TIP.



Anti-Peel Design
Cushion Grips

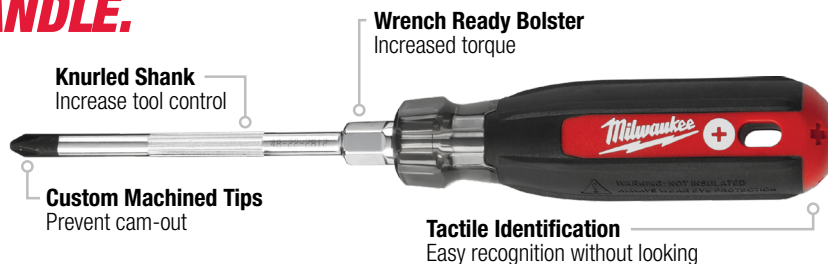

Knurled Shank
Increase tool control

Custom Machined Tips
Prevent cam-out

Wrench Ready Bolster
Increased torque

Tactile Identification
Easy recognition without looking

Model #	Description
48-22-2811	#1 Phillips (3")
48-22-2812	#2 Phillips (4")
48-22-2813	#3 Phillips (6")
48-22-2814	#2 Phillips (10")
48-22-2815	#2 Phillips (6") Cushion-Grip Demolition Screwdriver

Model #	Description
48-22-2821	1/4" Slotted (4")
48-22-2822	5/16" Slotted (6")
48-22-2824	3/8" Slotted (8")
48-22-2831	3/16" Cabinet (3")
48-22-2832	3/16" Cabinet (6")
48-22-2833	3/16" Cabinet (8")

Model #	Description
48-22-2834	1/4" Cabinet (10")
48-22-2841	#1 ECX™ (4")
48-22-2842	#2 ECX™ (4")
48-22-2851	#1 Square (3")
48-22-2852	#2 Square (4")
48-22-2853	#3 Square (6")

Model #	Description	Bit Types
48-22-2884	4 Pc Cushion-Grip Screwdriver Set	P#2, SL 1/4", SL 5/16", SL 6"
48-22-2885	5 Pc Cushion-Grip Screwdriver Set	P#2, SL 1/4", SL 5/16", SL 6"
48-22-2886	6 Pc Cushion-Grip Screwdriver Set	P#2, P#3, SL 1/4", SL 3/16", SL 5/16"

DEMO DRIVER

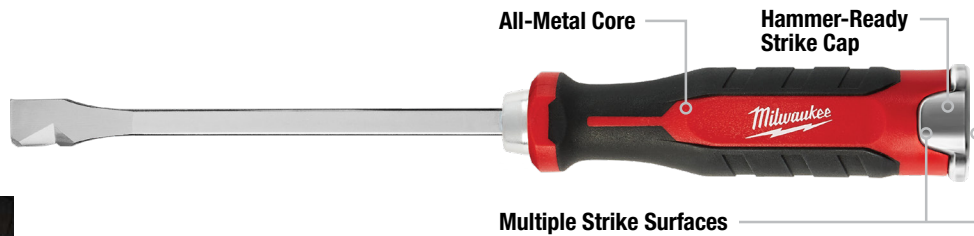

Aggressive Duct Piercing Tip

Model #	Description
48-22-2860	Demo Driver
48-22-2823	Slotted 5/16" 6" Cushion-Grip Demolition Screwdriver
48-22-2825	Slotted 3/8" 8" Cushion-Grip Demolition Screwdriver

1000V INSULATED SCREWDRIVERS

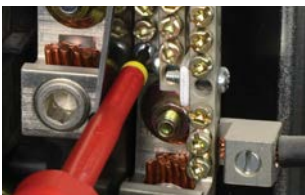
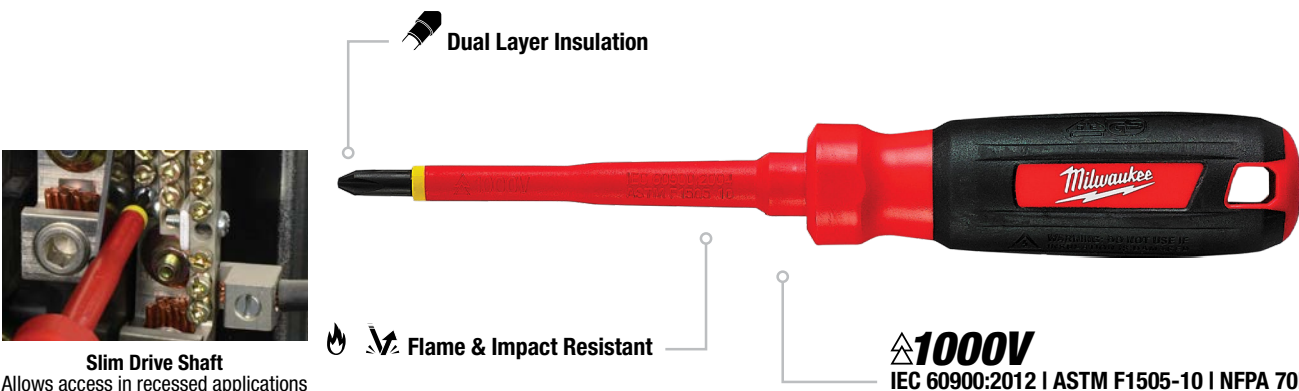

Slim Drive Shaft
Allows access in recessed applications

Model #	Description
48-22-2211	#1 Phillips (3")
48-22-2212	#2 Phillips (4")
48-22-2213	#3 Phillips (6")
48-22-2221	1/4" Slotted (6")
48-22-2222	5/16" Slotted (7")
48-22-2223	3/8" Slotted (8")
48-22-2224	3/8" Slotted (10")
48-22-2231	3/16" Cabinet (4")

Model #	Description
48-22-2232	3/16" Cabinet (6")
48-22-2233	3/16" Cabinet (8")
48-22-2241	#1 ECX™ (4")
48-22-2242	#2 ECX™ (4")
48-22-2251	#1 Square (3")
48-22-2252	#2 Square (4")
48-22-2253	#3 Square (6")

Model #	Description	Bit Types, Carrying Case
48-22-2202	3 Pc 1000V Insulated Screwdriver Set	P#2, SL 1/4", ECX™#1
48-22-2204	4 Pc 1000V Insulated Screwdriver Set w/ Case	P#1, P#2, SL 1/4", SL 3/8", Extra Capacity Roll Up Pouch
48-22-2205	4 Pc 1000V Insulated Screwdriver Set w/ Case	SL 1/4", SL 3/8", SQ#1, SQ#2, Extra Capacity Roll Up Pouch
48-22-2210	10 Pc 1000V Insulated Screwdriver Set w/ Case	P#1, P#2, P#3, SL 1/4", SL 5/16", SL 3/8", SQ#1, SQ#2, SQ#3, ECX™#1, EVA Foam Fitted Case
48-22-2203	3 Pc 1000V Insulated Screwdriver Set	#1 ECX™ (4"), #2 Phillips (4"), 1/4" Slotted (6")

PRECISION SCREWDRIVERS

UP TO **4X STRONGER**

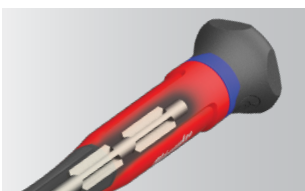
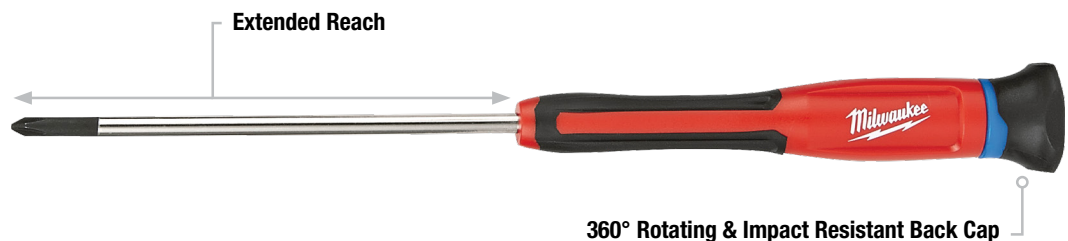

All-Metal Core

Model #	Description	Bit Types
48-22-2604	4 Pc Precision Screwdriver Set	P#1, SL 1/16", SL 3/32", SL 1/8"
48-22-2606	6 Pc Precision Screwdriver Set w/ Case	P#1, P#2, SL 1/16", SL 3/32", SL 1/8", SL 5/32"
48-22-2610	6 Pc TORX® Precision Screwdriver Set w/ Case	T6, T7, T8, T9, T10, T15

HOLLOWCORE™ MAGNETIC NUT DRIVERS

UNLIMITED DEPTH

FITS **4X** MORE FASTENERS



SAE METRIC

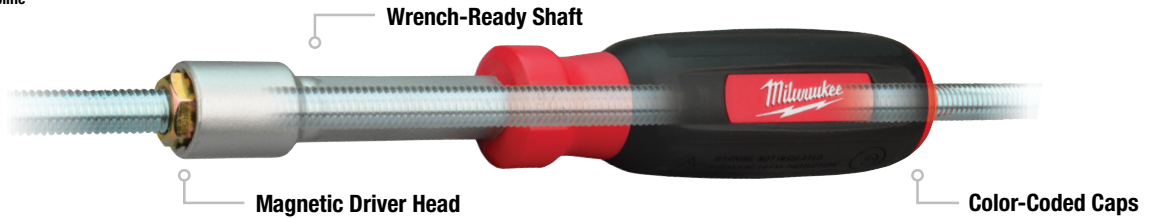

Model #	Description	Sizes
48-22-2502	2 Pc HOLLOWCORE™ Magnetic Nut Driver Set	1/4", 5/16"
48-22-2507	7 Pc HOLLOWCORE™ SAE Magnetic Nut Driver Set	1/4", 5/16", 11/32", 3/8", 7/16", 1/2", 9/16"
48-22-2517	7 Pc HOLLOWCORE™ Metric Magnetic Nut Driver Set	5mm, 5.5mm, 6mm, 7mm, 8mm, 10mm, 13mm

Model #	Description
48-22-2520	3/16" Magnetic Nut Driver
48-22-2521	1/4" HOLLOWCORE™ Magnetic Nut Driver
48-22-2522	5/16" HOLLOWCORE™ Magnetic Nut Driver
48-22-2523	11/32" HOLLOWCORE™ Magnetic Nut Driver
48-22-2524	3/8" HOLLOWCORE™ Magnetic Nut Driver

Model #	Description
48-22-2525	7/16" HOLLOWCORE™ Magnetic Nut Driver
48-22-2526	1/2" HOLLOWCORE™ Magnetic Nut Driver
48-22-2527	9/16" HOLLOWCORE™ Magnetic Nut Driver
48-22-2531	5mm HOLLOWCORE™ Magnetic Nut Driver
48-22-2532	5.5mm HOLLOWCORE™ Magnetic Nut Driver

Model #	Description
48-22-2533	6mm HOLLOWCORE™ Magnetic Nut Driver
48-22-2534	7mm HOLLOWCORE™ Magnetic Nut Driver
48-22-2535	8mm HOLLOWCORE™ Magnetic Nut Driver
48-22-2536	10mm HOLLOWCORE™ Magnetic Nut Driver
48-22-2537	13mm HOLLOWCORE™ Magnetic Nut Driver

HOLLOW SHAFT NUT DRIVERS

FITS **4X** MORE FASTENERS



SAE METRIC

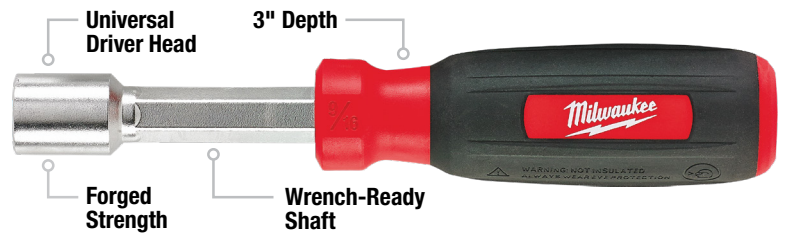

Model #	Description	Sizes
48-22-2402	2 Pc SAE Hollow Shaft Nut Driver Set	1/4", 5/16"
48-22-2404	4 Pc SAE Hollow Shaft Nut Driver Set	1/4", 5/16", 7/16", 9/16"
48-22-2407	7 Pc SAE Hollow Shaft Nut Driver Set	1/4", 5/16", 11/32", 3/8", 7/16", 1/2", 9/16"
48-22-2417	7 Pc Metric Hollow Shaft Nut Driver Set	5mm, 5.5mm, 6mm, 7mm, 8mm, 10mm, 13mm

Model #	Description
48-22-2420	3/16" Hollow Shaft Nut Driver
48-22-2421	1/4" Hollow Shaft Nut Driver
48-22-2422	5/16" Hollow Shaft Nut Driver
48-22-2423	11/32" Hollow Shaft Nut Driver
48-22-2424	3/8" Hollow Shaft Nut Driver

Model #	Description
48-22-2425	7/16" Hollow Shaft Nut Driver
48-22-2426	1/2" Hollow Shaft Nut Driver
48-22-2427	9/16" Hollow Shaft Nut Driver
48-22-2431	5mm Hollow Shaft Nut Driver
48-22-2432	5.5mm Hollow Shaft Nut Driver

Model #	Description
48-22-2433	6mm Hollow Shaft Nut Driver
48-22-2434	7mm Hollow Shaft Nut Driver
48-22-2435	8mm Hollow Shaft Nut Driver
48-22-2436	10mm Hollow Shaft Nut Driver
48-22-2437	13mm Hollow Shaft Nut Driver

FRAMING HAMMERS

UP TO
10x VIBRATION REDUCTION
SHOCKSHIELD™ GRIP

Available in



Smooth Face



Milled Face

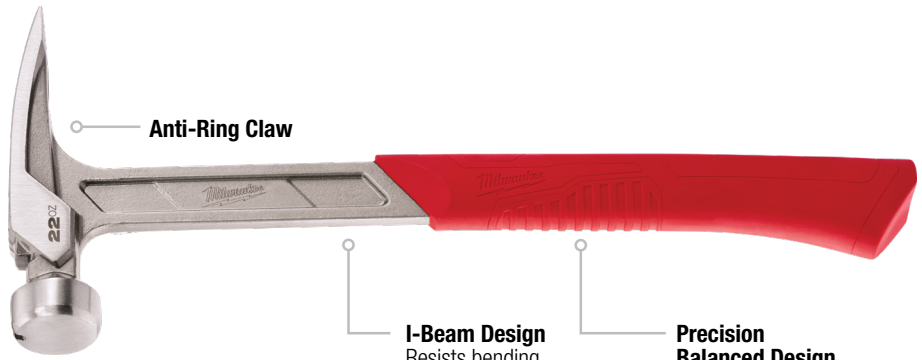

Magnetic Nail Set

Model #	Description
48-22-9016	17oz Milled Face Hammer
48-22-9017	17oz Smooth Face Hammer
48-22-9022	22oz Milled Face Hammer

Model #	Description
48-22-9023	22oz Smooth Face Hammer
48-22-9080	20oz Curved Claw Hammer

POLY FIBERGLASS HAMMER

MOST DURABLE FIBERGLASS HANDLE

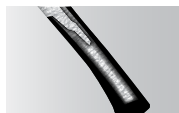

Reinforced Fiberglass Handle

Model #	Description
48-22-9316	19oz Smooth Face Poly/Fiberglass Hammer

HICKORY HAMMERS

BEST DRIVING PERFORMANCE



Magnetic Nail Set

Model #	Description
48-22-9419	19oz Hickory Hammer – Milled Face
48-22-9419	19oz Hickory Hammer – Smooth Face

HARDLINE™ FIXED BLADE KNIVES

ULTIMATE DURABILITY™
AUS-8 STEEL™



Multi-Position Sheath



Model #	Description
48-22-1928	5" HARDLINE™ Fixed Blade Knife
48-22-1928B	5" HARDLINE™ Fixed Blade Knife

LINEMAN, FIXED BLADE, & POCKET KNIVES

LINEMAN'S HAWKBILL KNIVES

STAYS SHARPER LONGER



Universal Hot Stick Compatible



STICKWORK™ 3in1 RING

- Shotgun Hot Stick Compatible
- Universal Hot Stick Compatible
- Hang Ring



Also Available:
Hawkbill Fixed Blade Knife
48-22-1925

Model #	Description
48-22-1923	Lineman's Hawkbill Knife with STICKWORK™ 3in1 Ring
48-22-1924	Lineman's Blunt Tip Hawkbill Knife with STICKWORK™ 3in1 Ring
48-22-1925	Hawkbill Fixed Blade Knife

LINEMAN'S UNDERGROUND KNIFE

STAYS SHARPER LONGER



Blade Cover Storage



Model #	Description
48-22-1929	Lineman's Underground Knife

FIXED BLADE KNIFE

STAYS SHARPER LONGER



Durable Sheath



Model #	Description
48-22-1926	4" Tradesman Fixed Blade Knife

HARDLINE™ POCKET KNIVES

EXTREME WEAR RESISTANCE™



Drop Point Smooth Blade



Model #	Description
48-22-1994	HARDLINE™ 3" Smooth Blade Pocket Knife
48-22-1997	HARDLINE™ 2-1/2" Smooth Blade Pocket Knife

Model #	Description
48-22-1998	HARDLINE™ 3" Serrated Blade Pocket Knife
48-22-1999	HARDLINE™ 3-1/2" Smooth Blade Pocket Knife

FASTBACK™ 5in1 FOLDING KNIFE

PRESS AND FLIP™



Bottle Opener

Model #	Description
48-22-1540	FASTBACK™ 5in1 Folding Knife

FASTBACK™ HAWKBILL FOLDING KNIVES

PRESS AND FLIP™



Ideal for Stripping Cable

Model #	Description
48-22-1525	FASTBACK™ Hawkbill Folding Knife
48-22-1526	FASTBACK™ Blunt Tip Hawkbill Folding Knife

FASTBACK™ FOLDING KNIVES

PRESS AND FLIP™



Also Available:



FASTBACK™ Camo Folding Knife
48-22-1524



Durable Wire Belt Clip
Reduces pocket tearing

Model #	Description
48-22-1520	FASTBACK™ Folding Knife
48-22-1525	FASTBACK™ Hawkbill Folding Flip Knife
48-22-1524	FASTBACK™ Camo Folding Knife

FASTBACK™ POCKET & FOLDING KNIVES

FASTBACK™ SPRING ASSISTED POCKET KNIVES

Spring Assisted



Partially Serrated



Also Available:



FASTBACK™ Camo Spring Assisted Knife
48-22-1996

Model #	Description
48-22-1530	FASTBACK™ Spring Assisted Knife
48-22-1535	FASTBACK™ Camo Spring Assisted Knife

LOCKBACK POCKET KNIFE



Lockback
Strong Secure Hold



Model #	Description
48-22-1940	Lockback Pocket Knife

FASTBACK™ COMPACT FOLDING KNIFE

PRESS AND FLIP



Blade Holder Designed for Scoring

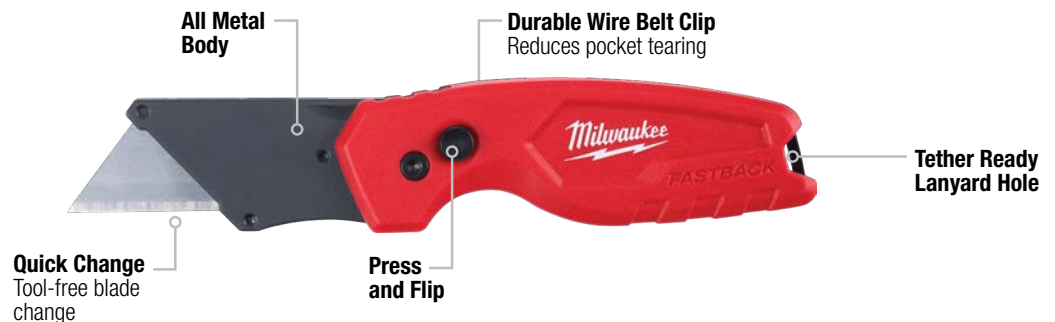

Model #	Description
48-22-1500	FASTBACK™ Compact Folding Utility Knife

FASTBACK™ UTILITY KNIVES

PRESS AND FLIP™

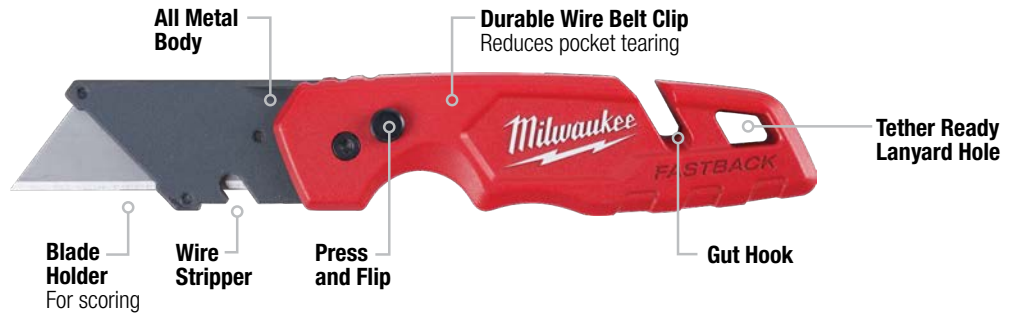

Wire Stripper

Model #	Description
48-22-1501	FASTBACK™ Folding Utility Knife
48-22-1502	FASTBACK™ Folding Utility Knife with Blade Storage
48-22-1503	FASTBACK™ Folding Utility Knife & FASTBACK™ Compact Knife Set

Model #	Description
48-22-1504	FASTBACK™ Folding Utility Knife with Blade Storage and 50 Pc General Blades
48-22-1901	FASTBACK™ Folding Utility Knife

SIDE SLIDING UTILITY KNIFE

MAXIMUM DEPTH CONTROL



Holds up to 5 Blades

Model #	Description
48-22-1510	Side Sliding Utility Knife

FIXED BLADE UTILITY KNIFE

FIXED BLADE



Overmold Grip

Model #	Description
48-22-1513	Fixed Blade Utility Knife

GENERAL PURPOSE

LASTS **5X LONGER**



General Purpose



HOOK

UP TO **2X STRONGER**



Ideal for Roofing



DRYWALL

UP TO **2X SHARPER**



Ideal for Drywall



CARTON

LASTS **5X LONGER**



Ideal for Cartons



Description	5 Pc	15 Pc (Case Included)	50 Pc (Dispenser Included)	75 Pc (Dispenser Included)	100 Pc (Dispenser Included)
General Purpose Utility Blades	48-22-1905	–	48-22-1950	48-22-1975	48-22-1900
Hook Utility Blades	48-22-1932	–	48-22-1952	–	–
Drywall Utility Blades	48-22-1933	–	48-22-1953	–	–
Carton Utility Blades	48-22-1934	–	48-22-1954	–	–
15 Pc Assorted Utility Blade Set	–	48-22-1930 (10) General Purpose, (2) Hook, (3) Carton	–	–	–

SELF RETRACTING UTILITY KNIFE

SAFETY CUTTER

UP TO **5X LONGER LIFE**

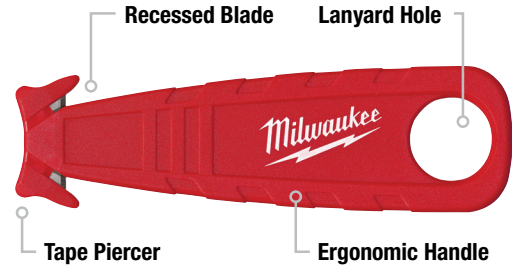

2 Blade Positions

Model #	Description
48-22-1512	Self Retracting Utility Knife

Model #	Description
48-22-1916	Safety Cutter

PRECISION SNAP-OFF KNIVES

METAL LOCK

UP TO **10X LONGER LIFE**



Model #	Description
48-22-1960	9mm (A) Precision Snap-Off Knife
48-22-1961	18mm (L) Precision Snap-Off Knife w/ Metal Lock

Model #	Description
48-22-1962	25mm (H) Precision Snap-Off Knife w/ Metal Lock

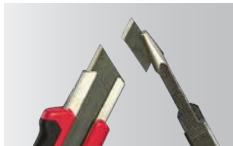

Blade Snap Off

Description	3 Pc	10 Pc
9mm (A) Precision Snap-Off Replacement Blades	48-22-9309	48-22-9109
18mm (L) Precision Snap-Off Replacement Blades	48-22-9318	48-22-9118
25mm (H) Precision Snap-Off Replacement Blades	48-22-9325	48-22-9125

GENERAL PURPOSE SNAP-OFF KNIVES

FASTER BLADE ADJUSTMENT

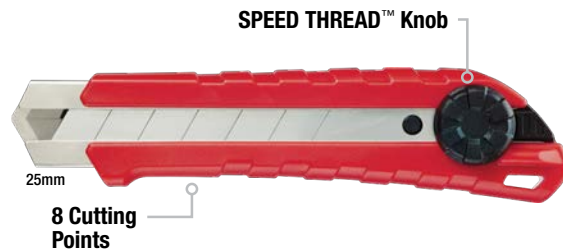

Model #	Description
48-22-1963	9mm (A) General Purpose Snap-Off Knife
48-22-1964	18mm (L) General Purpose Snap-Off Knife

Model #	Description
48-22-1965	25mm (H) General Purpose Snap-Off Knife



Blade Snap Off

Description	3 Pc	10 Pc
9mm (A) General Purpose Snap-Off Replacement Blades	48-22-1309	48-22-1109
18mm (L) General Purpose Snap-Off Replacement Blades	48-22-1318	48-22-1118
25mm (H) General Purpose Snap-Off Replacement Blades	48-22-1325	48-22-1125

INSULATION KNIVES

STAYS SHARPER LONGER

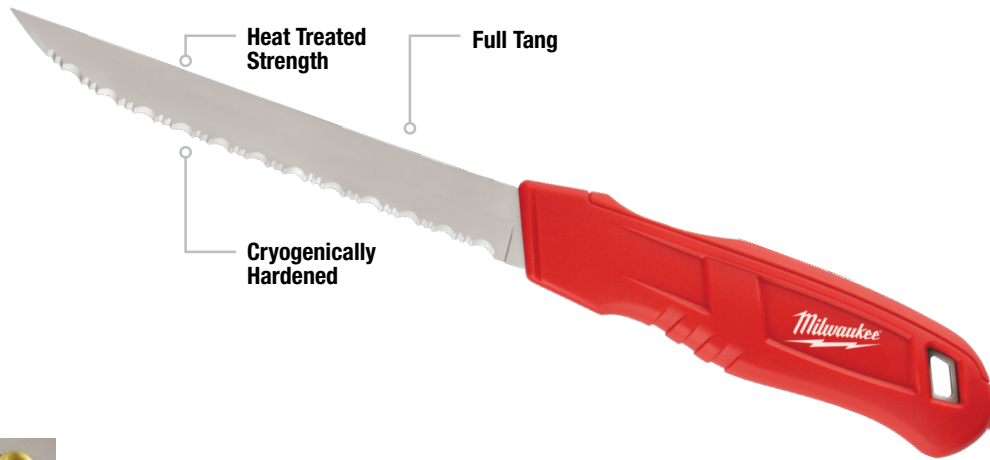

Rounded Handle
Smoothing Applications

Model #	Description
48-22-1921	Insulation Knife (Smooth)
48-22-1922	Insulation Knife (Serrated)

DUCT KNIFE

STAYS SHARPER LONGER

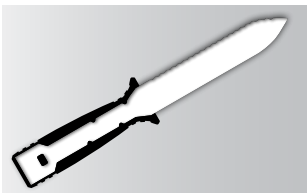
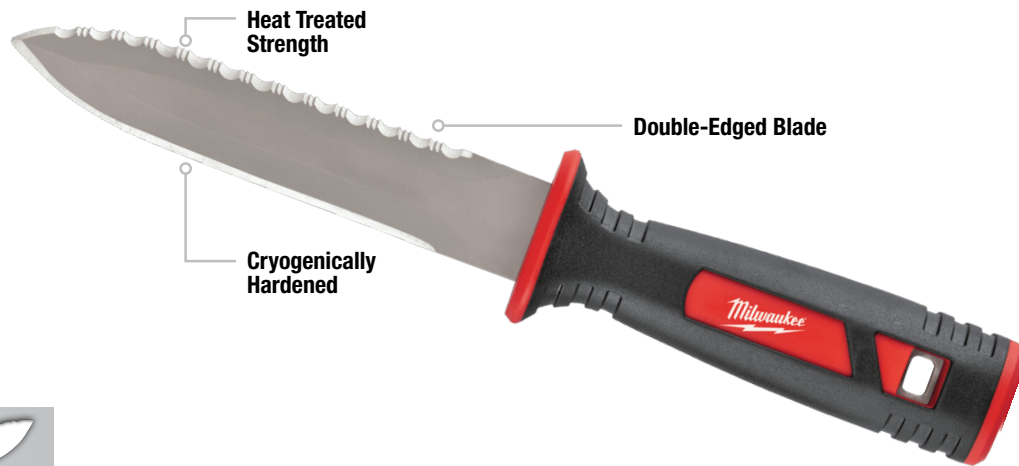

Full Tang

Model #	Description
48-22-1920	Duct Knife

AVIATION SNIPS

UP TO
10X MORE CUTS
FORGED BLADES



Flush Bolt Design
Won't hang up on material

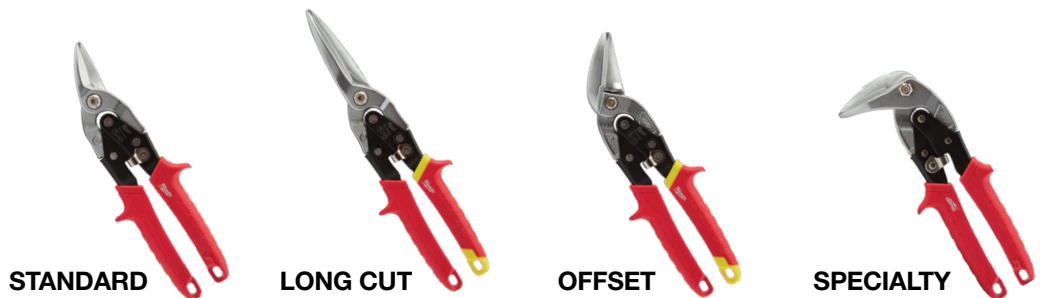

Model #	Description	Cold Rolled Steel	Stainless Steel
48-22-4530	Straight Cutting Standard Snips	18ga	22ga
48-22-4510	Left Cutting Standard Snips	18ga	22ga
48-22-4520	Right Cutting Standard Snips	18ga	22ga
48-22-4533	3 Pc Standard Snips Set	18ga	22ga
48-22-4532	Straight Cutting Offset Snips	18ga	22ga
48-22-4512	Left Cutting Offset Snips	18ga	22ga
48-22-4522	Right Cutting Offset Snips	18ga	22ga

Model #	Description	Cold Rolled Steel	Stainless Steel
48-22-4523	2 Pc Offset Snips Set	18ga	22ga
48-22-4537	Long Cut Straight Cutting Snips	20ga	22ga
48-22-4538	Long Cut Offset Snips	20ga	22ga
48-22-4500	Bulldog Snips	16ga	18ga
48-22-4511	Left Cutting Right Angle Snips	24ga	28ga
48-22-4521	Right Cutting Right Angle Snips	24ga	28ga

OFFSET COMPOUND TINNER

TOUGH CUTS

2X FORCE, LESS EFFORT

BOLT LOCK 



45° Offset
Cut clearance

Model #	Description
48-22-4005	Offset Compound Tinner

CLASSIC TINNERS

BLADES WILL NOT LOOSEN

BOLT LOCK 



40% Larger Handle Loops

Model #	Description
48-22-4003	10" Classic Tinner
48-22-4002	12" Classic Tinner
48-22-4001	16" Bulldog Tinner

DUCKBILL TINNER

BLADES WILL NOT LOOSEN

BOLT LOCK 



40% Larger
Handle Loops

Model #	Description
48-22-4004	10" Duckbill Tinner

LIGHTWEIGHT TINNER

STRAIGHTER, CLEANER CUTS

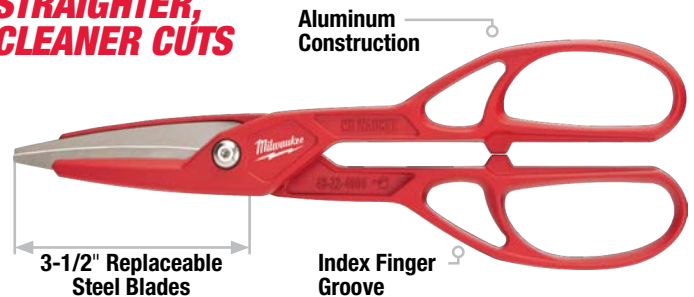

40% Larger
Handle Loops

Model #	Description
48-22-4006	13" Lightweight Tinner
48-22-4007	Lightweight Tinner Replacement Blades

JOBSITE SCISSORS

**ALL-METAL
HANDLES**
UP TO 10X LONGER LIFE

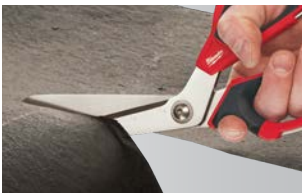

Index Finger Groove

Model #	Description
48-22-4040	Offset Jobsite Scissors (Serrated)

Model #	Description
48-22-4041	Straight Jobsite Scissors (Smooth)

ADAPTABLE BOLT CUTTERS w/ POWERMOVE™ EXTENDABLE ARMS

**MORE CUTS.
MAXIMUM VERSATILITY.**

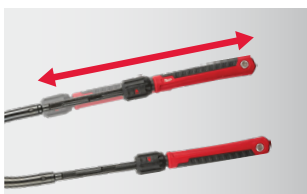

POWERMOVE™
Extendable Arms

Model #	Description	Max Capacity	
		Soft/Medium Materials (up to 31 HRC)	Hard Materials (up to 48 HRC)
48-22-4114	14" Adaptable Bolt Cutter	5/16"	3/16"
48-22-4124	24" Adaptable Bolt Cutter	7/16"	5/16"

BOLT CUTTERS & HACKSAWS

BOLT CUTTERS

**MORE CUTS.
LONGER LIFE.**



Forged Steel Blades & Custom Heat Treated
Maximum durability

Model #	Description	Max Capacity	
		Soft/Medium Materials (up to 31 HRC)	Hard Materials (up to 48 HRC)
48-22-4014	14" Bolt Cutter	5/16"	3/16"
48-22-4018	18" Bolt Cutter	3/8"	1/4"
48-22-4024	24" Bolt Cutter	7/16"	5/16"
48-22-4031	30" Bolt Cutter	1/2"	3/8"

HIGH-TENSION HACKSAW

**MOST DURABLE.
HIGHEST TENSION.**



45° Angle Blade Position

Model #	Description
48-22-0050	10 Pc 12" High-Tension Hacksaw
48-43-0600	10 Pc 12" 14TPI Hacksaw Blade
48-43-0610	10 Pc 12" 18TPI Hacksaw Blade

Model #	Description
48-43-0620	10 Pc 12" 24TPI Hacksaw Blade
48-43-0630	10 Pc 12" 32TPI Hacksaw Blade

COMPACT HACKSAW

UP TO 10X FASTER BLADE CHANGE



Compact Design



Model #	Description
48-22-0012	Compact Hacksaw

RASPING JAB SAW

UP TO 2X FASTER PLUNGE CUTS



Piercing Tip

Model #	Description
48-22-0304	Rasping Jab Saw

FOLDING JAB SAW

UP TO 10X FASTER BLADE CHANGE



Folding Blade

Model #	Description
48-22-0305	Folding Jab Saw

PVC/ABS SAWS

FAST CUTS THROUGH PVC



Metal Core

Model #	Description
48-22-0212	12" PVC/ABS Saw
48-22-0222	12" PVC/ABS Saw Replacement Blade
48-22-0223	18" PVC/ABS Saw
48-22-0220	18" PVC/ABS Saw Replacement Blade

TUBING/PIPE CUTTERS & REAMING PEN

TUBING CUTTER

INDESTRUCTIBLE FRAME



Replaceable Blades

Model #	Description
48-22-4202	Tubing Cutter
48-22-4203	Tubing Cutter Replacement Blade

RATCHETING PIPE CUTTERS

STRAIGHT, EASY CUTS



Comfortable Handle Design

Model #	Description
48-22-4210	1-5/8" Ratcheting Pipe Cutter
48-22-4211	1-5/8" Ratcheting Pipe Cutter Replacement Blade

Model #	Description
48-22-4215	2-3/8" Ratcheting Pipe Cutter
48-22-4216	2-3/8" Ratcheting Pipe Cutter Replacement Blade

REAMING PEN

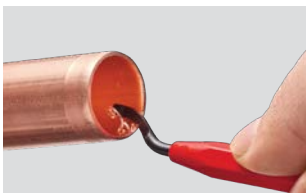

Copper

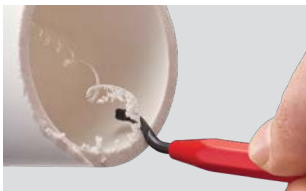

PVC



Model #	Description
48-22-4255	Reaming Pen

MINI COPPER TUBING CUTTERS

5X LONGER LIFE

REINFORCED ADJUSTMENT MECHANISM



Chrome Rollers Rust Protection

Model #	Description	Cut Capacity	Extra Blade
48-22-4250	1/2" Mini Copper Tubing Cutter	1/8" – 5/8"	—
48-22-4258	3/4" Mini Copper Tubing Cutter	1/8" – 7/8"	—
48-22-4251	1" Mini Copper Tubing Cutter	1/8" – 1-1/8"	Yes
48-22-4256	2 Pc Replacement Cutter Wheels		—

CLOSE QUARTERS COPPER TUBING CUTTERS

**MOST COMPACT.
LONGEST LIFE.**



Additional Storage Blades and reaming pen



Chrome Rollers Rust Protection

Model #	Description
48-22-4260	1/2" Close Quarters Copper Tubing Cutter
48-22-4261	3/4" Close Quarters Copper Tubing Cutter
48-22-4262	1" Close Quarters Copper Tubing Cutter
48-22-4263	3 Pc Close Quarters Copper Tubing Cutter Set
48-22-4266	Replacement Copper Tubing Cutter Wheels

QUICK-ADJUST TUBING CUTTERS

**STRAIGHTER,
CLEANER CUTS**

4 CHROME ROLLERS



Adapt to Cut 3" PEX



Chrome Rollers Rust Protection

Model #	Description	Cut Capacity
48-22-4253	2-1/2" Quick-Adjust Copper Tubing Cutter	1/2" – 2-5/8"
48-22-4254	3-1/2" Quick-Adjust Copper Tubing Cutter	1/2" – 3-1/2"
48-22-4256	2 Pc Replacement Cutter Wheels	—
48-22-4206	Replacement PEX Cutter Wheel	—

CONSTANT SWING COPPER TUBING CUTTERS

**STRAIGHTER,
CLEANER CUTS**

4 CHROME ROLLERS



Built-In Reamer on 48-22-4252



Chrome Rollers Rust Protection

Model #	Description	Cut Capacity
48-22-4259	1" Constant Swing Copper Tubing Cutter	1/8" – 1-1/8"
48-22-4252	1-1/2" Constant Swing Copper Tubing Cutter	1/8" – 1-5/8"
48-22-4256	2 Pc Replacement Cutter Wheels	—
48-22-4257	3 Pc Replacement Reaming Blade	—

PUNCHDOWN TOOL

**BEST ACCESS
& VISIBILITY**



Integrated LED Light

High / Low Impacting Function

Also Available:



Extended Reach Punchdown Blade
48-22-2166



Extended Reach Punchdown Blade

Model #	Description	Blades Included
48-22-2165	Punchdown Tool with Extended Blade	66/110 Combination and Extended Reach 110
48-22-2166	Extended Punchdown Blade	Extended Reach 110
48-22-2167	Punchdown Blade	66/110 Combination

MINI FLUSH CUTTER

**CONSISTENT,
PRECISE CUTS**



Light Weight



Spring Assisted

Model #	Description
48-22-6105	Mini Flush Cutter

RATCHETING MODULAR CRIMPER

**CONSISTENT,
ACCURATE CRIMPS**

Easy Access Jack Removal

In-Line Head Design

Ratcheting Mechanism



Parallel Crimping Design

Model #	Description
48-22-3075	Ratcheting Modular Crimper

MULTI-PICK TOOL

4in1

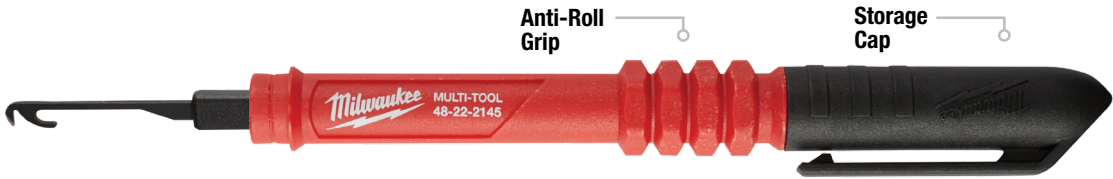

Model #	Description
48-22-2145	Multi-Pick Tool

ELECTRICIAN SNIPS

**BLADES WON'T LOOSEN.
BOLT LOCK**



Wire Gullet Prevents Walking

Model #	Description
48-22-4045	Electrician Snips

UTP STRIPPER

**COMFORTABLE,
ONE HAND OPERATION**



Optimized Finger Loop

Model #	Description
48-22-3065	UTP Stripper

CONDUIT BENDER

HIGH CONTRAST MARKINGS
BEST VISIBILITY

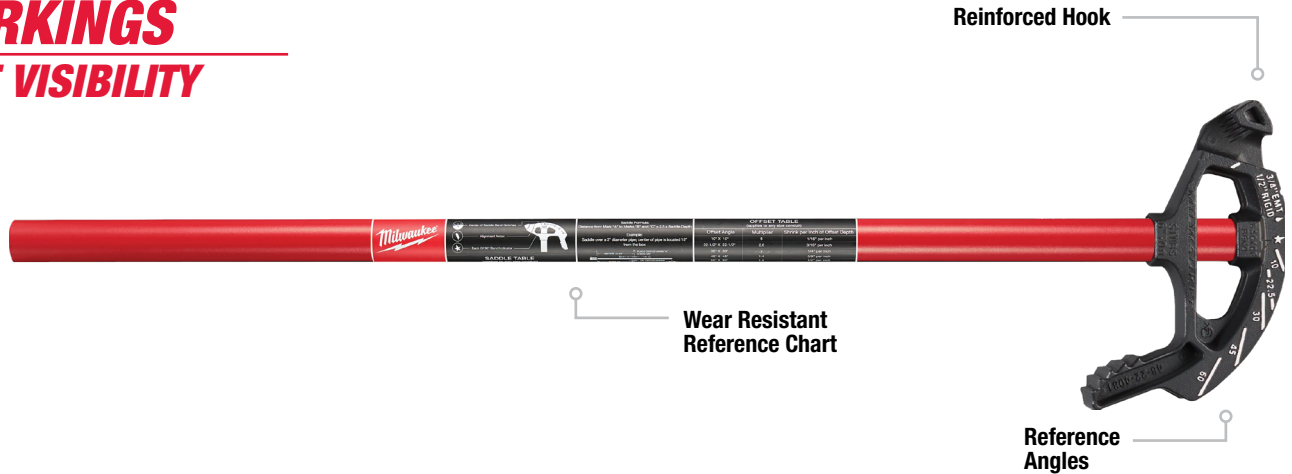

Reinforced Multi-Position Foot Pedal

Model #	Description
48-22-4080	1/2" Iron Conduit Bender
48-22-4081	3/4" Iron Conduit Bender
48-22-4082	1" Iron Conduit Bender
48-22-4070	1/2" Aluminum Conduit Bender
48-22-4071	3/4" Aluminum Conduit Bender

FISH STICKS

MOST DURABLE CONNECTIONS.
BRIGHTEST GLOW.



Reinforced Threaded Connection Points

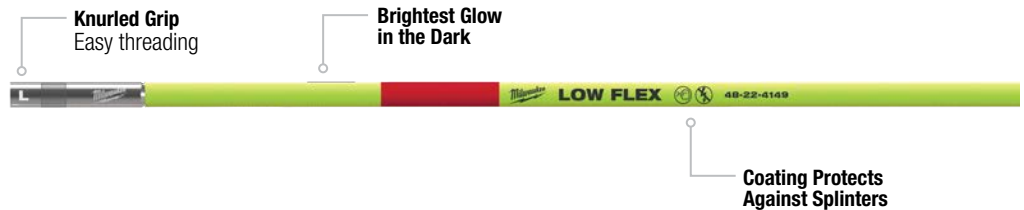

MET Part #	Description	Kit Includes
48-22-4149	5ft Low Flex Fish Stick	(1) 5' Low Flex Fish Stick, and Bullet Nose
48-22-4150	15ft Low Flex Fish Stick Kit	(3) 5' Low Flex Fish Sticks, Storage Tube, Bullet Nose and Hook
48-22-4151	5ft Mid Flex Fish Stick	(1) 5' Mid Flex Fish Stick, and Bullet Nose
48-22-4152	15ft Mid Flex Fish Stick Kit	(3) 5' Mid Flex Fish Sticks, Storage Tube, Bullet Nose and Hook
48-22-4153	5ft High Flex Fish Stick	(1) 5' High Flex Fish Stick, and Bullet Nose
48-22-4154	15ft High Flex Fish Stick Kit	(3) 5' High Flex Fish Sticks, Storage Tube, Bullet Nose and Hook

MET Part #	Description	Kit Includes
48-22-4160	25ft Fish Stick Combo Kit	(4) 5' Low Flex, (1) 5' Mid Flex Fish Sticks, (1) Storage Tube, Bullet Nose and Hook
48-22-4155	30ft Fish Stick Combo Kit	(4) 5' Low Flex, (1) 5' Mid Flex, (1) 5' High Flex Fish Sticks, (1) Storage Case, Bullet Nose, Hook, and Whisk
48-22-4156	60ft Fish Stick Combo Kit	(7) 5' Low Flex, (3) 5' Mid Flex, (2) 5' High Flex Fish Sticks, (1) Storage Case, Bullet Nose, Hook, Whisk, Magnet & Chain and Lighted Tip
48-22-4157	3 PC. Fish Stick Accessory Kit	(1) Whisk, Bullet Nose, and Hook
48-22-4158	Fish Stick Lighted Tip Accessory	(1) Lighted Tip Accessory
48-22-4159	Fish Stick Magnetic Tip and Chain Accessory	(1) Magnetic Tip and (1) Chain Accessory

POLYESTER FISH TAPES

**EASIEST FISHING.
MORE DURABLE TAPE.**

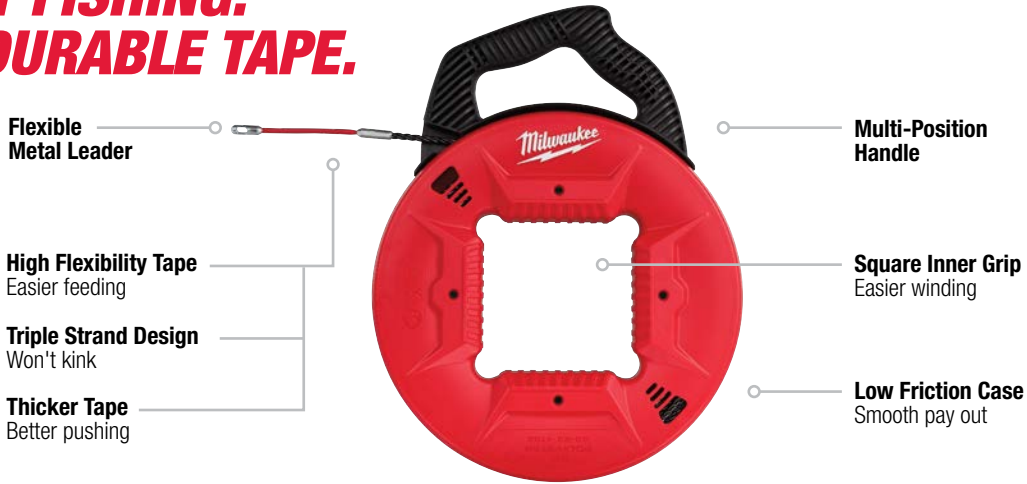

Also Available:



50ft Polyester Fish Tape with Nonconductive Tip
48-22-4162



High Flexibility Tape

Model #	Description
48-22-4192	50ft Polyester Fish Tape with Flexible Metal Leader
48-22-4195	100ft Polyester Fish Tape with Flexible Metal Leader
48-22-4197	200ft Polyester Fish Tape with Flexible Metal Leader
48-22-4162	50ft Polyester Fish Tape with Nonconductive Tip
48-22-4165	100ft Polyester Fish Tape with Nonconductive Tip
48-22-4167	200ft Polyester Fish Tape with Nonconductive Tip

STEEL FISH TAPES

**SMOOTH PAYOUT.
EASIER FISHING.**

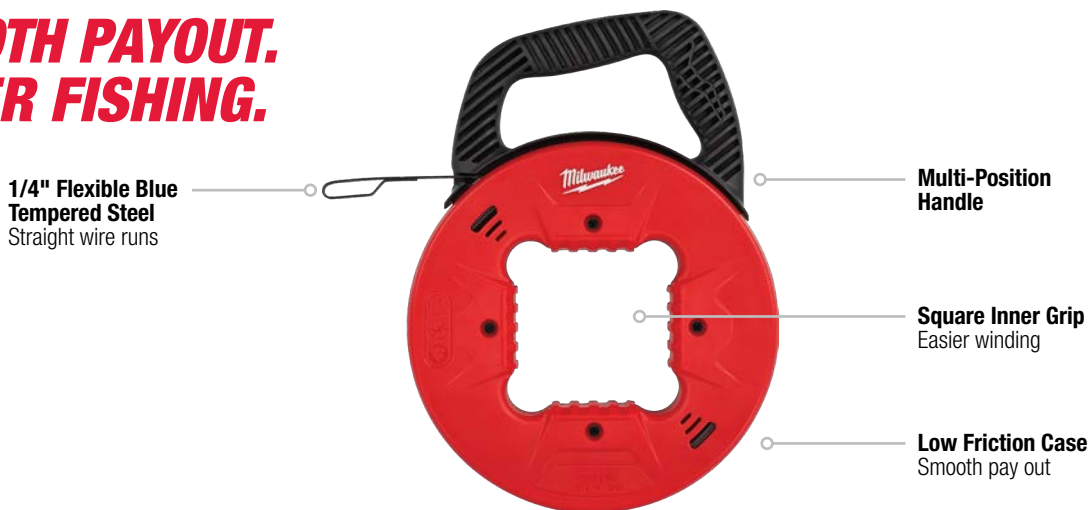

Laser Etched Markings

Model #	Description
48-22-4171	25ft 1/8" Steel Fish Tape
48-22-4172	50ft 1/8" Steel Fish Tape
48-22-4173	60ft 1/8" Steel Fish Tape
48-22-4176	120ft 1/8" Steel Fish Tape
48-22-4178	240ft 1/8" Steel Fish Tape
48-22-4181	25ft 1/4" Steel Fish Tape with Low Profile Tip
48-22-4185	100ft 1/4" Steel Fish Tape



PACKOUT™ MODULAR STORAGE

PACKOUT™

MOST VERSATILE
DURABLE
MODULAR STORAGE SYSTEM

TM



**FULLY
CUSTOMIZE
YOUR STORAGE™**



**IMPACT
RESISTANT™**



**IP65
RATED
PROTECTION™**



**BUILD
YOUR SYSTEM**

PACKOUT™ MODULAR STORAGE

ROLLING TOOL BOX



250 LBS CAPACITY™



IMPACT RESISTANT BODY™



9" ALL-TERRAIN WHEELS™

Modular Connectivity with All PACKOUT™ Components

Metal Reinforced Locking Point

IP65 Rated Protection



Industrial-Grade Extension Handle

Interior Organization Tray

Metal Reinforced Corners



9" All-Terrain Wheels

Model #	Description	Weight Capacity
48-22-8426	PACKOUT™ Rolling Tool Box	250 lbs

TOOL BOXES



IMPACT RESISTANT BODY™



IP65 RATED PROTECTION™



METAL-REINFORCED CORNERS™

Also Available:



PACKOUT™ Tool Box
48-22-8424

Metal Reinforced Locking Point

IP65 Rated Protection



Modular Connectivity with All PACKOUT™ Components

Metal Reinforced Corners



Interior Organizer Trays

Model #	Description	Weight Capacity
48-22-8424	PACKOUT™ Tool Box	75 lbs
48-22-8425	PACKOUT™ Large Tool Box	100 lbs

TOOL CASE WITH CUSTOMIZABLE INSERT



IMPACT RESISTANT BODY™



IP65 RATED PROTECTION™



CUSTOMIZE YOUR INSERT™

Also Available:



PACKOUT™ Customizable Foam Insert
48-22-8451

75lbs Weight Capacity

Impact Resistant Polymer Construction

Reinforced Locking Point



IP65 Rated Protection

Modular Connectivity with All PACKOUT™ Components



Customizable Foam Insert

Model #	Description	Weight Capacity
48-22-8450	PACKOUT™ Tool Case with Customizable Insert	75 lbs
48-22-8451	PACKOUT™ Customizable Foam Insert	—

COMPACT TOOL BOX



IMPACT RESISTANT BODY™



IP65 RATED PROTECTION™



QUICK-ADJUST DIVIDERS™

75 lbs Weight Capacity

Quick-Adjust Dividers

IP65 Rated Protection

Interior Storage Tray

Impact Resistant Body

Modular Connectivity with All PACKOUT™ Components



Interior Storage Tray



Model #	Description	Weight Capacity
48-22-8422	PACKOUT™ Compact Tool Box	75 lbs

16QT COOLER



HOLDS ICE FOR 30 HRS™



IMPACT RESISTANT BODY™



IP65 RATED PROTECTION™

16 qt Capacity

Bottle Opener

IP65 Rated Protection

Interior Storage Tray

Impact Resistant Body

Modular Connectivity with All PACKOUT™ Components



Integrated Bottle Opener



Model #	Description	Weight Capacity
48-22-8460	PACKOUT™ 16qt Compact Cooler	50 lbs

PACKOUT™ MODULAR STORAGE

CRATE



STACK OR HANG™



IMPACT RESISTANT BODY™



50 LBS CAPACITY™

50 lbs Weight Capacity

Stack or Hang

- Rear hanging points for vertical use
- Top attachment points for stacking



Stack or Hang



Modular Connectivity with All PACKOUT™ Components

Impact Resistant Polymer Construction

Model #	Description
48-22-8440	PACKOUT™ Crate

ORGANIZERS



IMPACT RESISTANT BODY™



IP65 RATED PROTECTION™



NO-TRAVEL BIN SEALS™

Also Available:



PACKOUT™ Compact Organizer
48-22-8435

No-Travel Bin Seals

Removable & Mountable Bins

IP65 Rated Protection



Impact Resistant Polymer Base

Modular Connectivity with All PACKOUT™ Components



Removable & Mountable Bins

Model #	Description
48-22-8430	PACKOUT™ Organizer
48-22-8435	PACKOUT™ Compact Organizer

LOW-PROFILE ORGANIZERS



IMPACT RESISTANT BODY™



IP65 RATED PROTECTION™



NO-TRAVEL BIN SEALS™

Also Available:



PACKOUT™ Low-Profile Organizer
48-22-8431

No-Travel Bin Seals

6 Removable Bin Dividers

IP65 Rated Protection

5 Removable Bins



Impact Resistant Polymer Base

Low-Profile Design

Modular Connectivity with All PACKOUT™ Components



Removable Bins

Model #	Description
48-22-8431	PACKOUT™ Low-Profile Organizer
48-22-8436	PACKOUT™ Low-Profile Compact Organizer

TOTES



TEAR-RESISTANT MATERIAL™



IMPACT RESISTANT BASE™



ALL-METAL HARDWARE™

Durable Overmold Handle

All-Metal Hardware

Also Available:



PACKOUT™ 10" Tote
48-22-8310



PACKOUT™ 15" Tote
48-22-8315

Padded Removable Shoulder Strap

Tear-Resistant 1680D Ballistic Material

Modular Connectivity with All PACKOUT™ Components



Impact Resistant Polymer Base



Optimized Storage Capacity

Model #	Description	Tool Pockets
48-22-8310	PACKOUT™ 10" Tote	28
48-22-8315	PACKOUT™ 15" Tote	31
48-22-8320	PACKOUT™ 20" Tote	32

TOOL BAGS



TEAR-RESISTANT MATERIAL™



IMPACT RESISTANT BASE™



ALL-METAL HARDWARE™

Versatile Carry
Cushioned shoulder strap,
top handles, side handles

Also Available:



PACKOUT™ 15" Tool Bag
48-22-8321

Spacious Storage Compartment

Tear-Resistant 1680D Ballistic Material

Modular Connectivity with All PACKOUT™ Components



All-Metal Hardware

Impact Resistant Polymer Base



Spacious Storage Compartment

Model #	Description
48-22-8321	PACKOUT™ 15" Tool Bag
48-22-8322	PACKOUT™ 20" Tool Bag

COOLER



HOLDS ICE FOR 24 HRS™



ALL-METAL HARDWARE™



IMPACT RESISTANT BASE™

Tape Measure Clip with Bottle Opener

Tear-Resistant Ballistic Material

Impact Resistant Polymer Base



Food-Grade Leak Proof Liner

All-Metal Hardware

No Sweat Exterior



Holds Ice for 24 Hours

Model #	Description
48-22-8302	PACKOUT™ Cooler

PACKOUT™ MODULAR STORAGE

BACKPACK



TEAR-RESISTANT MATERIAL™



IMPACT RESISTANT BASE™



OPTIMIZED STORAGE CAPACITY™

Tear-Resistant 1680D Ballistic Material

Hardshell Protected Electronic & Equipment Pocket

Impact Resistant Polymer Base

Load-Bearing Harness
 ■ Evenly distributes weight
 ■ Padded and breathable
 ■ Sternum strap

Tape Measure Clip

Modular Connectivity with All PACKOUT™ Components



Optimized Storage Capacity

Model #	Description	Tool Pockets
48-22-8301	PACKOUT™ Backpack	48

TECH BAG



TEAR-RESISTANT MATERIAL™



IMPACT RESISTANT BASE™



OPTIMIZED STORAGE CAPACITY™

Padded Shoulder Strap

Tear-Resistant 1680D Ballistic Material

Protected Interior Laptop Pocket

Impact Resistant Polymer Base

All-Metal Hardware

Hardshell Protected Instrument Pocket

Fold Down Front Pocket

Modular Connectivity with All PACKOUT™ Components



Optimized Storage Capacity

Model #	Description	Tool Pockets
48-22-8300	PACKOUT™ Tech Bag	58

MOUNTING PLATE



50 LBS
WALL MOUNTED
CAPACITY™



METAL-REINFORCED
MOUNTING
POINTS™

100 lbs Floor Mounted
Weight Capacity

50 lbs Wall Mounted
Weight Capacity

Modular Connectivity with
All PACKOUT™ Components

Metal Reinforced
Tie-Down Points

Impact Resistant
Polymer Construction

Metal-Reinforced
Mounting Holes



Wall & Floor Mounting

Model #	Description
48-22-8485	PACKOUT™ Mounting Plate

DOLLY



250 LBS
CAPACITY™



QUICKSTOP
LOADING LEVER™



SMOOTH
ROLL
WHEELS™

250 lbs Weight
Capacity

Modular Connectivity with
All PACKOUT™ Components

Impact Resistant
Polymer Construction

Locking Casters

Smooth Roll
Wheels



QUICKSTOP™ Loading Lever

Model #	Description
48-22-8410	PACKOUT™ Dolly

JOBSITE TECH BAG

UP TO **5X MORE DURABLE**

All-Metal Hardware

Integrated Rain Fly

Puncture Resistant Pocket

Impact-Resistant Base



Model #	Description
48-22-8210	Jobsite Tech Bag

HARDTOP™ ROLLING BAGS

MOST DURABLE. ULTIMATE VERSATILITY.

Industrial Grade Extension Handle

HARDTOP™ Construction
For stacking

Metal-Reinforced Skid Plates

6" All-Terrain Wheels

Padded Tech Pocket

All-Metal Rims & Through Axle



Model #	Description
48-22-8221	18" Rolling Bag
48-22-8220	24" HARDTOP™ Rolling Bag

JOBSITE COOLER

HOLDS ICE UP TO **24HRS**



2X the Insulation

Model #	Description
48-22-8250	Jobsite Cooler

LOW-PROFILE BACKPACK

**DURABLE,
LOW-PROFILE DESIGN**



1680D Ballistic Nylon

Model #	Description	Pockets
48-22-8202	Low-Profile Backpack	22

JOBSITE BACKPACK

UP TO **5X MORE DURABLE**



Impact-Resistant Base

Model #	Description	Pockets
48-22-8200	Jobsite Backpack	35

ULTIMATE JOBSITE BACKPACK

**ULTIMATE DURABILITY,
PROTECTION, & STORAGE**



Impact-Resistant Base

Model #	Description	Pockets
48-22-8201	Ultimate Jobsite Backpack	48

PARACHUTE ORGANIZER BAG

**FASTEST ACCESS,
BEST CONSTRUCTION**



Stand-Up & Stay-Open Design

Model #	Description
48-22-8170	Parachute Organizer Bag

BUCKET ORGANIZER WRAP

**MOST VERSATILE
BUCKET ORGANIZER**



Exterior Zipper Pockets

Model #	Description
48-22-8175	Bucket Organizer Wrap

ZIPPER POUCHES

UP TO **2X** MORE DURABLE



3 Pc Multi-Size Zipper Pouches
48-22-8183



Water Resistant Stand-Up Base

Model #	Description
48-22-8180	Zipper Pouch
48-22-8193	3 Pc Zipper Pouches
48-22-8183	3 Pc Multi-Size Zipper Pouches

JOBSITE ORGANIZER

**MOST VERSATILE
JOBSITE ORGANIZER**



No-Travel Bin Seals

Model #	Description
48-22-8030	20" Jobsite Organizer

WORK BELTS & POUCHES

UP TO **5X** LONGER LIFE

Contractor's Work Belt with Suspension Rig
48-22-8120



Electrician's Work Belt
48-22-8110

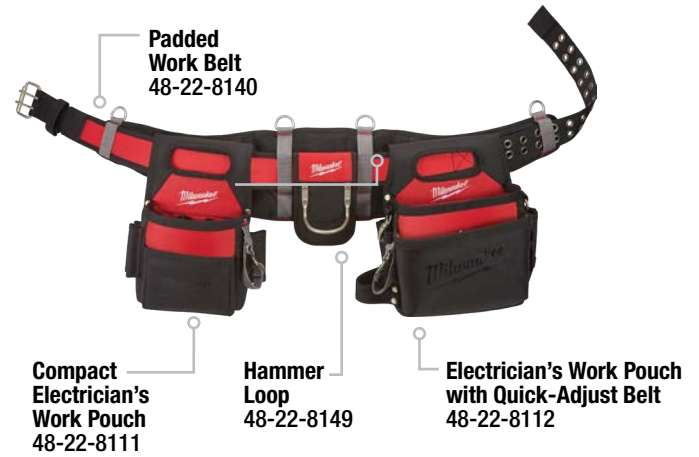

Model #	Description
48-22-8100	Electrician's Work Belt with Quick-Adjust Belt
48-22-8110	Electrician's Work Belt
48-22-8111	Compact Electrician's Work Pouch
48-22-8120	Contractor's Work Belt with Suspension Rig
48-22-8121	Carpenter's Work Pouch
48-22-8122	3-Tier Material Work Pouch

Model #	Description
48-22-8140	Padded Work Belt
48-22-8145	Padded Rig
48-22-8146	XL Padded Rig
48-22-8149	Hammer Loop
48-22-8112	Electrician's Work Pouch with Quick-Adjust Belt

COMPACT UTILITY POUCH

UP TO **5X** LONGER LIFE



Quick-Attach Belt Loop

Model #	Description
48-22-8118	Compact Utility Pouch

UTILITY POUCH



Quick-Attach Belt Loop

Model #	Description
48-22-8119	Utility Pouch

POWER UTILITY STORAGE

LINEMAN'S AERIAL TOOL APRON

**EASY ORGANIZATION.
LASTING DURABILITY.**



Dedicated Flood Light

Model #	Description
48-22-8290	Lineman's Aerial Tool Apron

UNDERGROUND OVAL BAG

UP TO 5X MORE DURABLE



Puncture Resistant Pockets

Model #	Description
48-22-8275	Underground Oval Bag

AERIAL OVAL BAG

UP TO **5X** MORE DURABLE

Puncture Resistant Knife Pockets

1680D Ballistic Material

Weep Holes
Let water out



2 Durable Eyelets

2 D-Rings
More storage

14 Pockets

Impact-Resistant Molded Base



Puncture Resistant Pockets

Model #	Description
48-22-8276	Aerial Oval Bag

CANVAS UTILITY BUCKET w/ POCKETS

**EASIEST ATTACHMENT.
LASTING DURABILITY.**

2 Internal Pockets

Reinforced Ring
Keeps bag open

Durable No. 6 Canvas

Weep Holes
Let water out



Large, Swiveling Metal Carabiner

2 D-Rings
Additional storage

Impact-Resistant Molded Base



Double Layered Canvas Construction

Model #	Description
48-22-8270	Canvas Utility Bucket w/ Pockets

DEMOLITION GLOVES WITH SMARTWIPE™

UP TO **5X LONGER LIFE**



Touch Screen Compatible Knuckle

ARMORTEX® Reinforced Thumb, Fingers and Padded Palm



TPR Knuckle Protection

Breathable Lining & Mesh Backing

Terry Cloth Sweat Wipe

Model #	Description
48-22-8735	Demolition Gloves S
48-22-8731	Demolition Gloves M
48-22-8732	Demolition Gloves L

Model #	Description
48-22-8733	Demolition Gloves XL
48-22-8734	Demolition Gloves XXL

PERFORMANCE GLOVES WITH SMARTWIPE™

ULTIMATE DURABILITY. ALL DAY COMFORT.

Also Available:



Performance Fingerless Gloves

High Dexterity Finger Tips

Reinforced Thumb Seam



Breathable Lining

Terry Cloth Sweat Wipe



Touch Screen Compatible Fingertips, Palm & Knuckle

Model #	Description
48-22-8725	Performance Gloves S
48-22-8721	Performance Gloves M
48-22-8722	Performance Gloves L
48-22-8723	Performance Gloves XL
48-22-8724	Performance Gloves XXL

Model #	Description
48-22-8745	Performance Fingerless Gloves S
48-22-8741	Performance Fingerless Gloves M
48-22-8742	Performance Fingerless Gloves L
48-22-8743	Performance Fingerless Gloves XL
48-22-8744	Performance Fingerless Gloves XXL

FREE-FLEX GLOVES WITH SMARTWIPE™

ULTIMATE DURABILITY. ALL DAY COMFORT.



Touch Screen Compatible Fingertips, Palm & Knuckle

High Dexterity Finger Tips

Reinforced Thumb Seam

Free-Flex Elastic Cuff



Terry Cloth Sweat Wipe

Model #	Description
48-22-8715	Free-Flex Gloves S
48-22-8711	Free-Flex Gloves M
48-22-8712	Free-Flex Gloves L

Model #	Description
48-22-8713	Free-Flex Gloves XL
48-22-8714	Free-Flex Gloves XXL

GOATSKIN LEATHER GLOVES

**COMFORTABLE LEATHER.
REINFORCED PALM.**



SMARTSWIPE™ Knuckle

Gunn Cut Construction
Added mobility

Reinforced Palm
Lasts Longer

Keystone Thumb
Comfortable Fit

SMARTSWIPE™
Touch Screen
Compatible
Fingertips & Palms

Soft Top Grain
Goatskin Leather



Size	1 Pair	12 Pair (Contractor Pack)
S	48-73-0010	48-73-0010B
M	48-73-0011	48-73-0011B
L	48-73-0012	48-73-0012B

Size	1 Pair	12 Pair (Contractor Pack)
XL	48-73-0013	48-73-0013B
XXL	48-73-0014	48-73-0014B

IMPACT DEMOLITION GLOVES

**IMPACT PROTECTION.
REINFORCED DURABILITY.**

ANSI / ISEA 138



Padded Palm

Padded Palm
Vibration dampening

Reinforced with
ARMORTEX®

Impact Rated
Enhanced TPR

Secure Hook
& Loop
Closure



Size	1 Pair	12 Pair (Contractor Pack)
S	48-22-8750	48-22-8750B
M	48-22-8751	48-22-8751B
L	48-22-8752	48-22-8752B

Size	1 Pair	12 Pair (Contractor Pack)
XL	48-22-8753	48-22-8753B
XXL	48-22-8754	48-22-8754B

WINTER DEMOLITION GLOVES

**ALL DAY WARMTH.
REINFORCED DURABILITY.**



Waterproof & Windproof Layer

40g
Insulation
Added warmth

Terry Cloth
Sweat Wipe

Durable Reinforced
Palm & Fingertips

SMARTSWIPE™
Touch Screen
Knuckle

Waterproof &
Windproof
Layer

Secure Hook
& Loop
Closure



Size	1 Pair	12 Pair (Contractor Pack)
S	48-73-0040	48-73-0040B
M	48-73-0041	48-73-0041B
L	48-73-0042	48-73-0042B

Size	1 Pair	12 Pair (Contractor Pack)
XL	48-73-0043	48-73-0043B
XXL	48-73-0044	48-73-0044B

WINTER PERFORMANCE GLOVES

ALL DAY WARMTH.



Durable Reinforced Palm and Fingertips



Size	1 Pair	12 Pair (Contractor Pack)
S	48-73-0030	48-73-0030B
M	48-73-0031	48-73-0031B
L	48-73-0032	48-73-0032B

Size	1 Pair	12 Pair (Contractor Pack)
XL	48-73-0033	48-73-0033B
XXL	48-73-0034	48-73-0034B

CUT LEVEL 1 INSULATED WINTER GLOVES

ULTIMATE WARMTH. ALL DAY COMFORT.

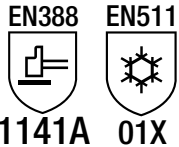

Size	1 Pair	12 Pair (Contractor Pack)
S	48-22-8910	48-22-8910B
M	48-22-8911	48-22-8911B
L	48-22-8912	48-22-8912B



Size	1 Pair	12 Pair (Contractor Pack)
XL	48-22-8913	48-22-8913B
XXL	48-22-8914	48-22-8914B

CUT LEVEL 3 INSULATED WINTER GLOVES

ULTIMATE WARMTH. ALL DAY COMFORT.

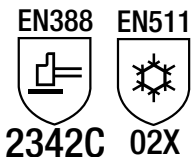

Size	1 Pair	12 Pair (Contractor Pack)
S	48-22-8920	48-22-8920B
M	48-22-8921	48-22-8921B
L	48-22-8922	48-22-8922B



Size	1 Pair	12 Pair (Contractor Pack)
XL	48-22-8923	48-22-8923B
XXL	48-22-8924	48-22-8924B

CUT LEVEL 1 DIPPED GLOVES WITH SMARTSWIPE™

**ULTIMATE DURABILITY.
ALL DAY COMFORT.**



Size	1 Pair	12 Pair (Contractor Pack)
S	48-22-8900	48-22-8900B
M	48-22-8901	48-22-8901B
L	48-22-8902	48-22-8902B

SMARTSWIPE™
Touch Screen
Compatible
Index Finger

High Dexterity
Fingertips

Nitrile Coated
Better grip



Nylon/Lycra Liner
All day comfort

Breathable
Backing

Color-Coded Bands
Easy cut rating
identification

Size	1 Pair	12 Pair (Contractor Pack)
XL	48-22-8903	48-22-8903B
XXL	48-22-8904	48-22-8904B

CUT LEVEL 3 DIPPED GLOVES WITH SMARTSWIPE™

**ULTIMATE DURABILITY.
ALL DAY COMFORT.**

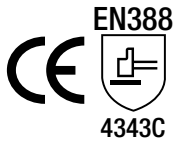

Size	1 Pair	12 Pair (Contractor Pack)
S	48-22-8930	48-22-8930B
M	48-22-8931	48-22-8931B
L	48-22-8932	48-22-8932B

SMARTSWIPE™
Touch Screen
Compatible
Fingertips & Palms

Nitrile Web Grip
Comfort



Best-In-Class
Puncture
Resistance

Breathable
Backing

Color-Coded Bands
Easy cut rating
identification

Size	1 Pair	12 Pair (Contractor Pack)
XL	48-22-8933	48-22-8933B
XXL	48-22-8934	48-22-8934B

CUT LEVEL 5 DIPPED GLOVES WITH SMARTSWIPE™

**ULTIMATE DURABILITY.
ALL DAY COMFORT.**

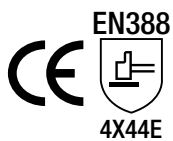

Size	1 Pair	12 Pair (Contractor Pack)
S	48-22-8950	48-22-8950B
M	48-22-8951	48-22-8951B
L	48-22-8952	48-22-8952B

SMARTSWIPE™
Touch Screen
Compatible
Fingertips & Palms

Double Dipped
Nitrile Coating
Best-in-class
durability



Best-In-Class
Puncture
Resistance

Breathable
Backing

Color-Coded Bands
Easy cut rating
identification

Size	1 Pair	12 Pair (Contractor Pack)
XL	48-22-8953	48-22-8953B
XXL	48-22-8954	48-22-8954

POLYURETHANE GLOVES

HIGH VISIBILITY CUT LEVEL 2 POLYURETHANE DIPPED GLOVES

**BETTER FIT.
BETTER PROTECTION.**

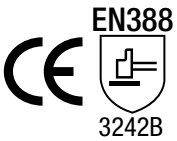

Size	1 Pair	12 Pair (Contractor Pack)
S	48-73-8920	48-73-8920B
M	48-73-8921	48-73-8921B
L	48-73-8922	48-73-8922B

15 Gauge for Better Dexterity

Reinforced Nitrile Coating

High Performance Added protection

Polyurethane Better fit



SMARTSWIPE™ Touch Screen Compatible Fingertips & Palms

Light and Breathable Back

Color-Coded Bands Easy cut rating identification

Size	1 Pair	12 Pair (Contractor Pack)
XL	48-73-8923	48-73-8923B
XXL	48-73-8924	48-73-8924B

HIGH VISIBILITY CUT LEVEL 3 POLYURETHANE DIPPED GLOVES

**BETTER FIT.
BETTER PROTECTION.**

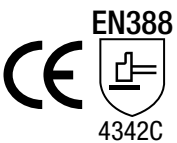

Size	1 Pair	12 Pair (Contractor Pack)
S	48-73-8930	48-73-8930B
M	48-73-8931	48-73-8931B
L	48-73-8932	48-73-8932B

15 Gauge for Better Dexterity

Reinforced Nitrile Coating

High Performance Added protection

Polyurethane Better fit



SMARTSWIPE™ Touch Screen Compatible Fingertips & Palms

Light and Breathable Back

Color-Coded Bands Easy cut rating identification

Size	1 Pair	12 Pair (Contractor Pack)
XL	48-73-8933	48-73-8933B
XXL	48-73-8934	48-73-8934B

HIGH VISIBILITY CUT LEVEL 4 POLYURETHANE DIPPED GLOVES

**BETTER FIT.
BETTER PROTECTION.**

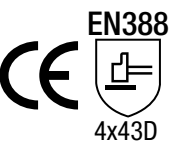

Size	1 Pair	12 Pair (Contractor Pack)
S	48-73-8940	48-73-8940B
M	48-73-8941	48-73-8941B
L	48-73-8942	48-73-8942B

Reinforced Nitrile Coating

High Performance Added protection

Polyurethane Better fit



SMARTSWIPE™ Touch Screen Compatible Fingertips & Palms

Light and Breathable Back

Color-Coded Bands Easy cut rating identification

Size	1 Pair	12 Pair (Contractor Pack)
XL	48-73-8943	48-73-8943B
XXL	48-73-8944	48-73-8944B

HARD HATS

ADAPT TO YOUR JOBSITE

- ANSI/ISEA Z89.1
- CSA Z94.1
- TYPE I CLASS C**
- ANSI/ISEA Z89.1
- CSA Z94.1
- TYPE I CLASS E**

Temperature Reducing Vents
On vented hard hats only

BOLT™ Reversible Headlamp Mount

- Securely holds MILWAUKEE® and most other professional brand headlamps
- Mounts to front or back

Quick-Adjust Ratcheting Suspension

4-Point Padded Suspension



Large Sun-Blocking Brim

Moisture Wicking Sweat Band

BOLT™ Marker Clip
Securely holds a marker or pencil

6 Accessory Slots

- 4 BOLT™ Accessory Slots
- 2 Universal Slots

ALSO AVAILABLE



Front Brim Hard Hat



Quick-Adjust Ratcheting Suspension

Large Logo	Small Logo	Description
48-73-1000	48-73-1001	Front Brim Vented Hard Hat – Type I Class C
48-73-1010	48-73-1011	Full Brim Vented Hard Hat – Type I Class C
48-73-1020	48-73-1021	Front Brim Hard Hat – Type I Class E
48-73-1030	48-73-1031	Full Brim Hard Hat – Type I Class E
48-73-1080	—	Hard Hat Sweat Band
48-73-1082	—	Hard Hat Chin Strap
48-73-1085	—	BOLT™ Hard Hat Marker Clip
48-73-1090	—	BOLT™ Hard Hat Headlamp Mount
48-73-1095	—	4-Point Ratchet Suspension Replacement
2111-21	—	USB Rechargeable Hard Hat Headlamp Kit
2103	—	Headlamp

Headlamp and marker not included.

HIGH VISIBILITY PERFORMANCE SAFETY VESTS

CARRY MORE. REINFORCED POCKETS.

15 Pockets

External:

- 2 Mic Tabs
- 1 Clear ID Holder
- 2 Chest Pockets
- 4 Reinforced Pen Pockets
- 2 Reinforced Barrel Pockets
- 1 Tablet Pocket

Internal:

- 1 Chest Pocket
- 2 Barrel Pockets

ANSI/ISEA 107-15
TYPE R CLASS 2
 CSA Z96-15
CLASS 2



ALSO AVAILABLE



ANSI/CSA Safety Vests

Size	Yellow – ANSI	Orange – ANSI	Yellow – ANSI/CSA	Orange – ANSI/CSA
S/M	48-73-5041	48-73-5051	48-73-5081	48-73-5091
L/XL	48-73-5042	48-73-5052	48-73-5082	48-73-5092
2XL/3XL	48-73-5043	48-73-5053	48-73-5083	48-73-5093
4XL/5XL	48-73-5044	48-73-5054	48-73-5084	48-73-5094

HIGH VISIBILITY SAFETY VESTS

CARRY MORE

10 Pockets

External:

- 2 Mic Tabs
- 1 Clear ID Holder
- 2 Chest Pockets
- 4 Reinforced Pen Pockets

Internal:

- 1 Chest Pocket

ANSI/ISEA 107-15
TYPE R CLASS 2
 CSA Z96-15
CLASS 2

Secure Zippered Closure



ALSO AVAILABLE



ANSI/CSA Safety Vests

Size	Yellow – ANSI	Orange – ANSI	Yellow – ANSI/CSA	Orange – ANSI/CSA
S/M	48-73-5021	48-73-5031	48-73-5061	48-73-5071
L/XL	48-73-5022	48-73-5032	48-73-5062	48-73-5072
2XL/3XL	48-73-5023	48-73-5033	48-73-5063	48-73-5073
4XL/5XL	48-73-5024	48-73-5034	48-73-5064	48-73-5074

MILWAUKEE® enables you to add logos or taglines to your hard hat and safety vest. The order process makes it easy to customize your PPE with long lasting prints.

HARD HAT CUSTOMIZATION

Hard Hat Logo Placement

Up to 4 locations



Front



Back



Left Side



Right Side

Hard Hat	Logo Size
Front/Back	2.5" W x 2" H
Sides	2.5" W x 2" H

PRINT UP TO 4 COLORS

HARD HAT CUSTOMIZATION

Safety Vest Logo Placement

Up to 2 locations



Left Pocket



Back



Lower Back

Safety Vest – ANSI	Logo Size
Left Pocket	3" W x 2.5" H
Back	9" W x 9" H
Performance Safety Vest – ANSI	Logo Size
Left Pocket	3" W x 2.5" H
Back	10" W x 6" H
Safety Vest – ANSI/CSA	Logo Size
Left Pocket	3" W x 2.5" H
Lower Back	15" W x 6" H
Performance Safety Vest – ANSI/CSA	Logo Size
Left Pocket	3" W x 2" H
Lower Back	15" W x 6" H

PRINT UP TO 2 COLORS

HOW TO SUBMIT ORDER

1. Place order through Sales Representative, Customer Experience, or MILWAUKEE® Connect
2. Once order is placed, an email will be sent with a link to the logo upload process
3. You will then receive an email with a link to review and approve a proof

LEAD TIME

- Artwork Proof will be sent within 1 business day after finishing the logo upload process
- Order will be fulfilled within 14 – 21 days from proof approval

ORDER MINIMUMS

- Hard Hats: Minimum order quantity of 36, must add in increments of 18
- Safety Vests: Minimum order quantity of 36, must add in increments of 36

MORE INFORMATION

- Email CXCustomSafety@milwaukeetool.com with questions

Once artwork is approved by the customer, the order cannot be canceled. Lead times are based on artwork approval date, not order date. If customer fails to approve artwork, order may be delayed. Orders placed with a mismatch on number of colors, locations, or logos will need to have the artwork updated or the order re-entered. Images may have some distortion on curved surfaces – the printer can accommodate for some, but it may not turn out the same as the flat image.

SAFETY GLASSES

PERFORMANCE SAFETY GLASSES WITH GASKET

**ADVANCED PROTECTION.
ULTIMATE PERFORMANCE.**



Case Included



Lens Color	Packaging Style – Blister Card	Packaging Style – Bag
Polarized	48-73-2045	48-73-2046
Clear	48-73-2040	48-73-2041

PERFORMANCE SAFETY GLASSES

**HIGH IMPACT
FOG-FREE LENSES**



Lens Color	Packaging Style – Blister Card	Packaging Style – Bag
Tinted	48-73-2025	48-73-2026
Clear	48-73-2020	48-73-2021

SAFETY GLASSES

**ANTI-FOG.
ANTI-SCRATCH.**



ALSO AVAILABLE



Clear
Safety Glasses



Lens Color	Packaging Style – Blister Card	Packaging Style – 3 Pk Blister Card	Packaging Style – Bag
Tinted	48-73-2005	48-73-2051	48-73-2006
Clear	48-73-2000	48-73-2050	48-73-2001

N95 VALVED RESPIRATORS

**STAY COOL.
BETTER FIT.**

ALSO AVAILABLE



N95 Valved Respirator



**NIOSH
N95**

N95 VALVED RESPIRATOR WITH GASKET

MET Part #	Description
48-73-4001	N95 Valved Respirator with Gasket
48-73-4002	3 Pk N95 Valved Respirator with Gasket
48-73-4004	10 Pk N95 Valved Respirator with Gasket

N95 VALVED RESPIRATOR

MET Part #	Description
48-73-4011	N95 Valved Respirator
48-73-4012	3 Pk N95 Valved Respirator
48-73-4014	10 Pk N95 Valved Respirator

REUSABLE CORDED EAR PLUGS

ALL DAY COMFORT



**NRR
26**

MET Part #	Description
48-73-3151	3 Pk Reusable Corded Ear Plugs

EAR PLUGS

ALL DAY COMFORT



**NRR
32**

MET Part #	Description
48-73-3001	10 Pair Ear Plugs
48-73-3005	100 Pair Ear Plugs
48-73-3006	100 Pair Ear Plugs (Individually Wrapped)

LOCKING TOOL LANYARDS

BEST SHOCK ABSORPTION

ANSI/ISEA

121-18



Individualized Serial Numbers
Inventory management

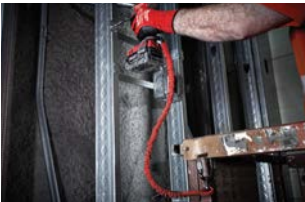

Tether Tools When Working at Height

Part #	Weight Rating	Description
48-22-8810	10 lbs	10 lbs Locking Tool Lanyard
48-22-8811	10 lbs	10 lbs 54" Extended Reach Locking Tool Lanyard
48-22-8812	10 lbs	10 lbs 72" Extended Reach Locking Tool Lanyard
48-22-8815	15 lbs	15 lbs Locking Tool Lanyard
48-22-8816	15 lbs	15 lbs 54" Extended Reach Locking Tool Lanyard
48-22-8817	15 lbs	15 lbs 72" Extended Reach Locking Tool Lanyard
48-22-8850	35 lbs	35 lbs Locking Tool Lanyard

QUICK-CONNECT LOCKING TOOL LANYARD SYSTEM

BEST SHOCK ABSORPTION

ANSI/ISEA

121-18



Quick Tool Change Out

Part #	Weight Rating	Description
48-22-8820	10 lbs	10 lbs Quick-Connect Locking Tool Lanyard
48-22-8822	5 lbs	3 Pc 5 lbs Quick-Connect Lanyard Accessory
48-22-8823	10 lbs	3 Pc 10 lbs Quick-Connect Lanyard Accessory

ANCHOR STRAP

TETHER MORE TOOLS, MORE PLACES

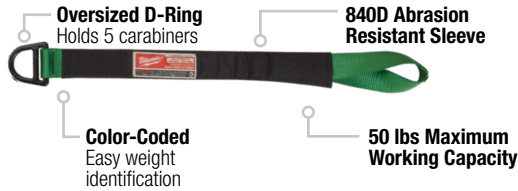

**ANSI/SEA
121-18**

Model #	Weight Rating	Description
48-22-8855	50 lbs	50 lbs Anchor Strap

WRIST LANYARDS

ALL DAY COMFORT



Model #	Weight Rating	Description
48-22-8830	5 lbs	5 Pc Wrist Lanyard
48-22-8835	5 lbs	5 lbs Quick-Connect Wrist Lanyard

TAPE & D-RING WEB ATTACHMENTS

EASILY CONNECT



Model #	Weight Rating	Description
48-22-8860		12' Self-Adhering Tape
48-22-8870	2 lbs	5 Pc 2 lbs D-Ring Web Attachment
48-22-8871	5 lbs	5 Pc 5 lbs D-Ring Web Attachment
48-22-8872	35 lbs	D-Ring 35 lbs Web Attachment

SPLIT RINGS

EASILY CONNECT

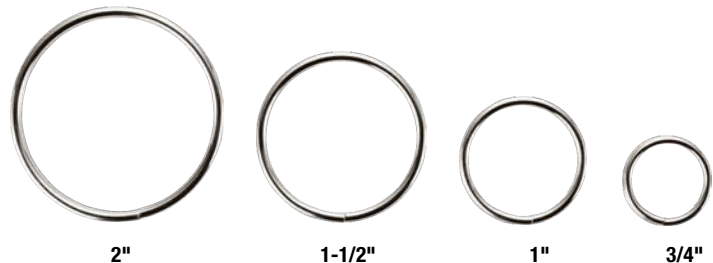

Model #	Weight Rating	Description
48-22-8880	2 lbs	5 Pc 2 lbs 3/4" Split Ring
48-22-8881	2 lbs	5 Pc 2 lbs 1" Split Ring
48-22-8882	2 lbs	5 Pc 2 lbs 1-1/2" Split Ring
48-22-8883	2 lbs	5 Pc 2 lbs 2" Split Ring

2	TAPE MEASURES
4	LONG TAPES & MEASURING WHEELS
5	REDSTICK™ LEVELS
7	REDSTICK™ CONCRETE LEVELS & TORPEDO LEVELS
8	SQUARES & LASER DISTANCE METERS
9	FOLDING RULES & CHALK REELS
10	INKZALL™ JOBSITE MARKERS
11	INKZALL™ PAINT MARKERS, PENS & HIGHLIGHTERS
12	FASTENING PLIERS
13	FASTENING & CUTTING PLIERS
14	CUTTING PLIERS
15	COMBINATION & MULTI-FUNCTION PLIERS
16	APPLICATION SPECIFIC PLIERS
17	TORQUE LOCK™ PLIERS, C-CLAMPS & SPECIALTY
18	RATCHETING BOX WRENCHES & POWER UTILITY WRENCH
19	POWER UTILITY WRENCH & PIPE WRENCHES
20	PIPE WRENCHES
21	PIPE WRENCHES & MULTI BIT DRIVERS
22	ADJUSTABLE & BASIN WRENCHES
23	RATCHET & SOCKET SETS
24	RATCHETING COMBINATION WRENCHES
25	COMBINATION WRENCHES
26	SOCKETS
27	DRIVE RATCHETS, BREAKER BARS & SOCKET ACCESSORIES
28	HOOK AND PICK SET & MULTI-BIT DRIVERS
29	SCREWDRIVERS
30	DEMO DRIVERS & SCREWDRIVERS
31	NUT DRIVERS
32	HAMMERS & FIXED BLADE KNIVES
33	LINEMAN, FIXED BLADE, & POCKET KNIVES
34	FASTBACK™ FOLDING KNIVES
35	FASTBACK™ POCKET & FOLDING KNIVES
36	FASTBACK™ UTILITY KNIVES & UTILITY KNIVES
38	UTILITY, SAFETY, & SNAP OFF KNIVES
39	INSULATION & DUCT KNIVES
40	AVIATION SNIPS
41	TINNERS
42	SCISSORS,& BOLT CUTTERS
43	BOLT CUTTERS & HACKSAWS
44	SAWS
45	TUBING/PIPE CUTTERS & REAMING PEN
47	COPPER TUBING CUTTERS
48	LOW VOLTAGE VDV
50	CONDUIT BENDERS
51	FISH TAPES
52	PACKOUT™ MODULAR STORAGE
59	BAGS
60	COOLERS & BACKPACKS
61	BACKPACKS
62	ORGANIZERS
64	WORK BELTS & UTILITY POUCHES
65	POWER UTILITY STORAGE
67	WORK GLOVES
69	NITRILE GLOVES
71	POLYURETHANE GLOVES
72	HARD HATS
73	SAFETY VESTS
74	PRODUCT CUSTOMIZATION
75	SAFETY GLASSES
76	RESPIRATORS
77	LANYARDS
78	LANYARD ACCESSORIES



MILWAUKEE TOOL
13135 West Lisbon Road
Brookfield, WI 53005

milwaukeetool.com

