



**FALCON®**

Locks

Product catalog



**FALCON**<sup>®</sup>

## The Falcon difference

Safety, security and uncompromising value

At Falcon, we know that every product you sell not only has to meet local building codes, but also your expectations for performance and quality. We take your expectations seriously, and that's why we build our locks to deliver durability, convenience and unmatched value. After all, we've built our reputation on the same standards that you have – providing quality products at a reasonable price, delivered on time. It's the way we do business and it's what makes Falcon locks a powerful choice no matter your project.





Locks overview

Falcon offers Grade 1 and Grade 2 cylindrical, deadbolt, mortise, interconnected, and extra-heavy duty pre-assembled unit locks that fit a variety of applications and door functions.



T Series



K Series



B Series



W Series



RU Series

	Cylindrical				Unit
<b>Features</b>	<ul style="list-style-type: none"> <li>Grade 1 certified</li> <li>Wide variety of functions and options</li> <li>Can accept competitive conventional, SFIC and FSIC cylinders</li> </ul>	<ul style="list-style-type: none"> <li>Grade 1 certified</li> <li>Most common functions, lever styles and finishes</li> <li>Affordable price</li> <li>Accepts conventional and SFIC cylinders</li> </ul>	<ul style="list-style-type: none"> <li>Grade 2 certified</li> <li>Designed for durability at a Grade 2 price point</li> <li>Accepts conventional and SFIC cylinders</li> </ul>	<ul style="list-style-type: none"> <li>Grade 2 certified</li> <li>Two rose diameter options to match most commercial door trim</li> <li>Accepts conventional and SFIC cylinders</li> </ul>	<ul style="list-style-type: none"> <li>Grade 1 certified</li> <li>Old-fashioned fit with modern strength, security and convenience</li> <li>Can accept competitive conventional, SFIC and FSIC cylinders</li> </ul>
<b>Application</b>	<ul style="list-style-type: none"> <li>Ideal for new construction and retrofit applications where Grade 1 security is needed</li> </ul>	<ul style="list-style-type: none"> <li>Where Grade 1 security and reliability are needed, but cost is a concern</li> </ul>	<ul style="list-style-type: none"> <li>Where frequent use is expected and durability is needed, but Grade 1 security isn't required</li> </ul>	<ul style="list-style-type: none"> <li>As a price sensitive solution orderable in a wide selection of designs and finishes</li> </ul>	<ul style="list-style-type: none"> <li>Retrofitting older and historical buildings where Grade 1 security is required</li> </ul>
<b>Options</b>	<ul style="list-style-type: none"> <li>13 mechanical/2 electrified commercial functions</li> <li>8 finishes</li> <li>7 lever designs</li> </ul>	<ul style="list-style-type: none"> <li>8 commercial functions</li> <li>2 finishes</li> <li>3 lever designs</li> </ul>	<ul style="list-style-type: none"> <li>10 commercial functions</li> <li>5 finishes</li> <li>2 lever designs</li> </ul>	<ul style="list-style-type: none"> <li>11 commercial lever functions</li> <li>9 commercial knob functions</li> <li>8 finishes</li> <li>7 lever/2 knob designs</li> <li>2 rose options</li> </ul>	<ul style="list-style-type: none"> <li>10 mechanical/2 electrified commercial functions</li> <li>2 finishes</li> <li>2 lever designs</li> </ul>



MA Series

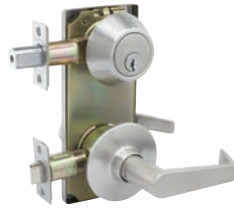

H2 Series

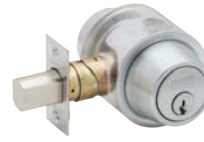

D100 Series











D200 Series

	Mortise	Interconnected	Deadbolt	
<b>Features</b>	<ul style="list-style-type: none"> <li>Grade 1 certified</li> <li>One of Falcon's toughest locks—built to stand up to constant use without fail</li> <li>Accepts conventional and SFIC cylinders</li> </ul>	<ul style="list-style-type: none"> <li>Grade 2 certified</li> <li>Large inner plate that connects lock and deadbolt</li> <li>Exterior has the appearance of a tubular lock and deadbolt</li> <li>Accepts conventional and SFIC cylinders</li> </ul>	<ul style="list-style-type: none"> <li>Grade 1 certified for security</li> <li>Hardened steel bolt with anti-saw pin</li> <li>Supplemental protection against break-in</li> <li>Accepts conventional and SFIC cylinders</li> </ul>	<ul style="list-style-type: none"> <li>Grade 2 certified for security</li> <li>Zinc bolt with anti-saw pin</li> <li>Supplemental protection against break-in</li> <li>Accepts conventional and SFIC cylinders</li> </ul>
<b>Application</b>	<ul style="list-style-type: none"> <li>Where a reliable and durable Grade 1 security lock is required</li> <li>Facilities where a large variety of functions are needed</li> </ul>	<ul style="list-style-type: none"> <li>Where strength and security are required, but cost is a concern</li> <li>Use in multi-family applications for supplemental security with one-step egress</li> </ul>	<ul style="list-style-type: none"> <li>Where supplemental, Grade 1 security is required</li> </ul>	<ul style="list-style-type: none"> <li>Where supplemental, Grade 2 security is required</li> </ul>
<b>Options</b>	<ul style="list-style-type: none"> <li>26 mechanical/2 electrified commercial functions</li> <li>9 finishes</li> <li>8 lever designs</li> <li>1 knob design</li> <li>Rose (sectional) and escutcheon options</li> </ul>	<ul style="list-style-type: none"> <li>2 commercial functions</li> <li>6 finishes</li> <li>8 lever designs</li> </ul>	<ul style="list-style-type: none"> <li>5 commercial functions</li> <li>5 finishes</li> </ul>	<ul style="list-style-type: none"> <li>8 commercial functions</li> <li>5 finishes</li> </ul>

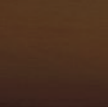
## Ordering information

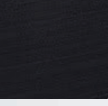
## Finishes

The latest in modern techniques and equipment are used to apply the highest quality finish. Extra steps assure durable, consistent finishes and long, useful life.

Color	BHMA number	US number	Cylindrical				Unit	Mortise	Interconnect	Deadbolt		Housing faces	Cylinder faces
			T	K	B	W	RU	MA	H2	D100	D200		
 Bright brass	605	US3	■	■	■		■	■	■	■	Mortise and rim	SFIC	
 Satin brass	606	US4	■	■	■		■			■	Mortise and rim	SFIC Conventional	
 Oil rubbed bronze	613	US10B	■	■	■	■ <sup>2</sup>	■			■	Mortise and rim	SFIC	
 Satin nickel	619	US15	■			■ <sup>1</sup>		■ <sup>4</sup>	■		Mortise and rim		
 Matte black	622	US19	■			■ <sup>1</sup>		■ <sup>4</sup>	■		Mortise and rim	SFIC Conventional	
 Bright chrome	625	US26	■	■	■		■	■	■	■		SFIC	
 Satin chrome	626	US26D	■	■	■	■	■	■	■	■	Mortise and rim	SFIC Conventional	
 Satin stainless steel	630	US32D						■ <sup>5</sup>			Mortise and rim <sup>3</sup>		
 Aged bronze	643e	US11	■			■ <sup>1</sup>		■ <sup>4</sup>	■		Mortise and rim	SFIC	

<sup>1</sup> Finish available for lever options only.

<sup>2</sup> Finish available for Dane lever option only.

<sup>3</sup> Also available in 629 bright stainless steel.

<sup>4</sup> Knobs not available in 619, 622 and 643e finish.

<sup>5</sup> Latitude, Longitude, Broadway and Boardwalk not available in 630 finish.

Although we apply the finest available protective plating and/or enamel coating to the surface of our products, these finishes have limitations and in time may deteriorate either from exposure to weather, pollution, perspiration, extremes of climate, frequency of use or other factors. Deterioration of these finishes is, therefore, not a defect, but a normal process which is unavoidable. Please reference product warranty for more information.

Ordering information

# How to order

For correct ordering and to help ensure no delays in the shipment of your product, follow the information sequence below. Additional information for each category can be found on other pages of this catalog and in the Falcon price book. Deadbolt ordering information can be found on page 55.

**Example: FAL-MA521P-LGN-619-LTG-218-LH**

Brand		Product number				Trim				Door detail				Keyway	Hand	Other requirements
1	2	3	4	5	6	5	6	7	8	9	10	11	12	13		
		Series	Func	Cylinder suffix	Outside		Inside		Latch part #	Strike part #	Door thickness <sup>1</sup>	Extension	Keyway	Hand <sup>2</sup>	Examples <sup>3</sup>	
FAL	-	MA	521	P6	-	LGN - 619	-	LTG	-	-	218	-	-	LH	-	
FAL	-	T	561	CP6	-	9Q - 619	-	-	-	23981129	-	-	-	Schlage C	-	A23160-OKD
Defaults to factory standard if not specified.																

1. Enter door thickness if non-standard. Examples: 2 1/2" = 212; 2 1/4" = 214.
2. Specify for MA Series only.
3. Examples include: Latch height (RU Series only), competitive keyway cylinder part number, master keying requirements, Allegion Connect.

**Detail**

1	<b>Brand:</b> Falcon=FAL												
2	<b>Series:</b> Lock series MA, T, K, B, W, RU, or H2												
3	<b>Function:</b> Choose from cylindrical function list (page 10), MA list (page 46), and H2 list (page 51).												
4	<p><b>Cylinder suffix:</b> Choose cylinder type</p> <table border="0"> <tr> <td><b>B</b> Less SFIC</td> <td><b>H</b> SFIC refundable construction core</td> <td><b>P</b> 6-pin conventional cylinder (pinned to 5)</td> </tr> <tr> <td><b>BB</b> SFIC, Best style</td> <td><b>L</b> Less 6-pin conventional cylinder</td> <td><b>P6</b> 6-pin conventional cylinder (pinned to 6)<sup>3</sup></td> </tr> <tr> <td><b>BDC</b> SFIC disposable construction core</td> <td><b>J</b> Less FSIC<sup>2</sup> (T and RU Series only)</td> <td><b>P7</b> 7-pin conventional cylinder (pinned to 7)</td> </tr> <tr> <td><b>G<sup>1</sup></b> SFIC, Falcon style<sup>1</sup></td> <td></td> <td><b>CP6</b> 6-pin conventional cylinder, Schlage C</td> </tr> </table>	<b>B</b> Less SFIC	<b>H</b> SFIC refundable construction core	<b>P</b> 6-pin conventional cylinder (pinned to 5)	<b>BB</b> SFIC, Best style	<b>L</b> Less 6-pin conventional cylinder	<b>P6</b> 6-pin conventional cylinder (pinned to 6) <sup>3</sup>	<b>BDC</b> SFIC disposable construction core	<b>J</b> Less FSIC <sup>2</sup> (T and RU Series only)	<b>P7</b> 7-pin conventional cylinder (pinned to 7)	<b>G<sup>1</sup></b> SFIC, Falcon style <sup>1</sup>		<b>CP6</b> 6-pin conventional cylinder, Schlage C
<b>B</b> Less SFIC	<b>H</b> SFIC refundable construction core	<b>P</b> 6-pin conventional cylinder (pinned to 5)											
<b>BB</b> SFIC, Best style	<b>L</b> Less 6-pin conventional cylinder	<b>P6</b> 6-pin conventional cylinder (pinned to 6) <sup>3</sup>											
<b>BDC</b> SFIC disposable construction core	<b>J</b> Less FSIC <sup>2</sup> (T and RU Series only)	<b>P7</b> 7-pin conventional cylinder (pinned to 7)											
<b>G<sup>1</sup></b> SFIC, Falcon style <sup>1</sup>		<b>CP6</b> 6-pin conventional cylinder, Schlage C											
5	<p><b>Outside/inside trim:</b> Indicate letter of available knob or lever design followed by letter of rose or escutcheon design when appropriate. (Examples: MA and W Series have various rose and/or escutcheon options)</p> <table border="0"> <tr> <td><b>Abrasive strip tactile warning</b> Preface the design code with 6 (Ex: 6DA for DAN). Not available in 613 finish, Latitude, Longitude, Broadway and Boardwalk levers.</td> <td><b>Knurled tactile warning</b> Preface the design code with 8 (Ex: 8EG for Elite Gala). Not available on all lever styles and finishes. See MA Series section for details.</td> <td><b>Lead lining</b> Preface the design code with 9 (Ex: 9DA for DAN). Not available on all lever styles. See series section for details. Available on T, RU and MA Series.</td> </tr> </table>	<b>Abrasive strip tactile warning</b> Preface the design code with 6 (Ex: 6DA for DAN). Not available in 613 finish, Latitude, Longitude, Broadway and Boardwalk levers.	<b>Knurled tactile warning</b> Preface the design code with 8 (Ex: 8EG for Elite Gala). Not available on all lever styles and finishes. See MA Series section for details.	<b>Lead lining</b> Preface the design code with 9 (Ex: 9DA for DAN). Not available on all lever styles. See series section for details. Available on T, RU and MA Series.									
<b>Abrasive strip tactile warning</b> Preface the design code with 6 (Ex: 6DA for DAN). Not available in 613 finish, Latitude, Longitude, Broadway and Boardwalk levers.	<b>Knurled tactile warning</b> Preface the design code with 8 (Ex: 8EG for Elite Gala). Not available on all lever styles and finishes. See MA Series section for details.	<b>Lead lining</b> Preface the design code with 9 (Ex: 9DA for DAN). Not available on all lever styles. See series section for details. Available on T, RU and MA Series.											
6	<b>Outside/inside finish:</b> Choose outside finish from available options. Fill in inside finish if different.												
7	<b>Latch part number:</b> See cylindrical product page for options. Specify only if non-standard backset is required. Specify LLL for less latch.												
8	<b>Strike part number:</b> See product page for options. Specify only if non-standard strike is required. Specify LLL for less strike.												
9	<b>Door thickness:</b> See product page for options. Specify only if non-standard door thickness is required.												
10	<p><b>Extension:</b> Enter one of the following when door specified is 2" or greater. (Ei or EO assumes the latch will be centered on a 1 3/4" door to which material has been added.)</p> <table border="0"> <tr> <td><b>EE</b> Extended Equally</td> <td><b>EI</b> Extended Inside</td> </tr> <tr> <td><b>EO</b> Extended Outside</td> <td><b>ED</b> Extended Differently</td> </tr> </table>	<b>EE</b> Extended Equally	<b>EI</b> Extended Inside	<b>EO</b> Extended Outside	<b>ED</b> Extended Differently								
<b>EE</b> Extended Equally	<b>EI</b> Extended Inside												
<b>EO</b> Extended Outside	<b>ED</b> Extended Differently												
11	<b>Keyway:</b> G keyway (KD) is standard when ordering P, P6 or P7 conventional cylinders; A keyway (KD) is standard when ordering BB, BDC, G or H SFIC cylinders. Other keyways available.												
12	<b>Handing:</b> Provide handing when ordering MA Series. All cylindrical locks are field handed.												
13	<p><b>Additional requirements:</b></p> <ul style="list-style-type: none"> <li>▪ Latch height when specifying RU Series locks</li> <li>▪ Competitive keyway cylinders: Specify part number<sup>3</sup></li> <li>▪ Keying detail: Blockokey or additional keys (with quantity) requests, large bow keys, master keying (Example: Grand Master keyed, Master keyed, change key, etc.)</li> <li>▪ Allegion Connect</li> </ul>												

1. 6-pin standard, specify G7 if 7-pin is desired.
2. Reference T and RU Series' cylinder pages for list of compatible competitor FSIC cylinders. Note the competitive cylinder brand and model in the "Other requirements" section so that a proper tailpiece can be supplied.
3. Specify P6 and list the cylinder part number under "other requirements" if a 6-pin competitive keyway cylinder is desired (see series' cylinder pages for options).

**Door handing**

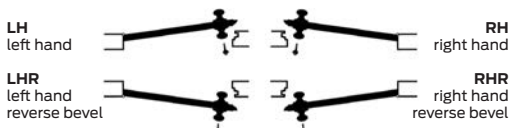

The hand is determined by the direction the door swings when viewed from the exterior or corridor side of the door.

Ordering information

# Large and small format keying

## Conventional large format keyways

"G" keyway is standard for all Falcon conventional cylinders and will be supplied unless otherwise specified. The multiplex key system structure is used to expand keying systems which require more than one keyway.

Falcon bored locksets are also available with the most common competitive open keyways. Falcon does not offer master keying of competitive keyways with the exception of Schlage C keyway. For more information on large format keying options, please reference each lock series section.

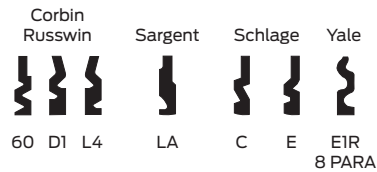

## Falcon multiplex key family

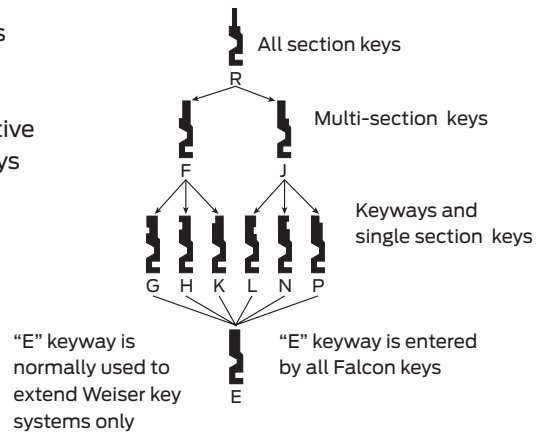

## Small Format Interchangeable Core (SFIC) keyways



The "A" keyway is standard for SFIC products and will be supplied unless otherwise specified. Falcon keyways shown here are equivalent to Best and Arrow SFIC keyways of the same names.



Consult factory for restricted keyways not listed here. When ordering locks or cores master keyed into existing Best, Arrow or other compatible SFIC systems, a copy of the bitting list for the existing system is required with the order.

## A2, A3 and A4 systems

Falcon master keying uses the A2 System (depths 0-9) standard. We can provide cores into competitors' A4 (depths 0-5) key systems but we generate new A4 systems solely at the discretion of our Key Systems Department. We do not support the A3 System (Depths 0-6). However, any Falcon core can be combined to A3 specs in the field.

## SFIC cylinders

	Uncombined		Combined	
	6-pin	7-pin	6-pin	7-pin
Falcon cover style (standard)	C646	C647	C606	C607
Best style capping	CB846	CB847	CB806	CB807
No logo	C648	C649	C608	C609
No logo, Best capping	CB848	CB849	CB808	CB809

Note: The "A" keyway is standard and will be supplied unless otherwise specified. If ordering cylinders as parts, specify finish: 605, 606, 613, 622, 625, 626 or 643e.

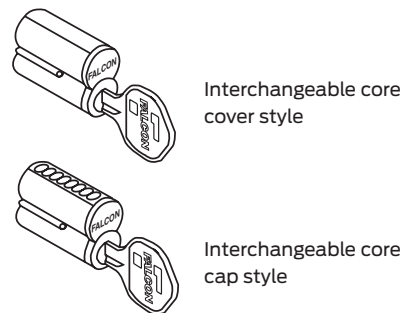

## Compatibility with competitors' SFIC cylinders

Falcon locksets also accept Schlage SFIC, Arrow (including Flex Core), Best (including PKs and Peaks), InstaKey, Kaba Peaks, Keymark and KSP cores. When specifying "B" for less SFIC cylinder, please note that these manufacturer's cylinders all fit the Falcon lever and spring cage configuration. The appropriate Falcon tailpiece will be provided with the lockset.



## Ordering information

# Construction keying options

Falcon offers various pathways to achieve either temporary or permanent cylinder construction keying. Temporary cylinder use is limited to small format keying since SFIC cylinders, by nature, are easily interchanged. Falcon conventional cylinders can be construction keyed using the "lost pin," (also known as "lost ball") method or the Falcon Blockokey® insert. In both cases, temporary construction keys are used with the permanent cylinders during construction to protect the integrity of the master key system. Once the project is complete, new owners can clear the cylinder of construction keying and begin to use the permanent operating keys.

### Disposable SFIC construction core (specify BDC as the cylinder suffix)

This disposable plastic core is intended for use only when security is not a concern. When inserted into the lever, knob or mortise housing, this keyless core simply acts as a thumbturn to retract the latch bolt. Perimeter or higher security areas should use the Falcon SFIC construction cylinder.

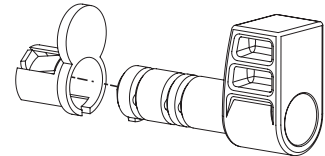

### Refundable SFIC construction cylinders (specify H as the cylinder suffix)

Falcon brass construction cores are provided keyed alike to a combination unrelated to the permanent system's master key. Upon project completion, these cylinders are replaced with the permanent SFIC cylinders and returned to Allegion for credit.

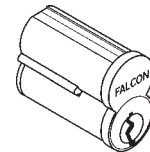

### "Lost pin" conventional cylinders (specify "lost pin" or part 50-211 under additional details)

Lost pin uses the job site's permanent conventional cylinders supplied with a shallow hole in the side of the plug. An extra pin is inserted into the cylinder on top of one of the bottom pins. Use of a temporary construction key allows the pin to stay in the cylinder and still function normally as an operating key. Upon project completion, a master key inserted into the cylinder and rotated right will push the pin into the hole and eliminate any possible future use of the construction key.

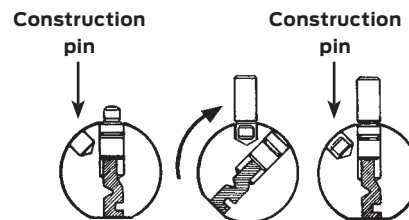
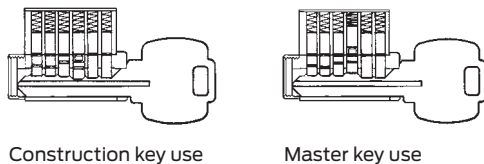

### Locks with Blockokey® cylinder inserts

All locks for a specific project are provided with a key blocking insert and a special construction key. Duplicates of this key may be assigned by the building contractor to workmen and subcontractors as required. No regular change keys or Master keys are needed on the job. This eliminates the possibility of subsequent exposure from lost or stolen keys.

### How to order locks with Blockokey® inserts

Simply add the word "Blockokey" (part 50-212) in the additional details section. Any Falcon conventional cylinder can be ordered with Blockokey inserts but there are some limitations on keyway availability. Check with customer service for details. Example: FAL-MA521PD-AG-619-RH-Blockokey

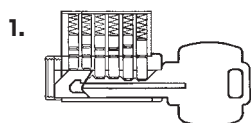

#### 1. Construction key use

Lock cylinder is operated by the special "construction key." The last two pins in the cylinder are held inoperative by the key block.

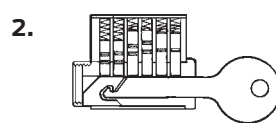

#### 2. Removal tool use

The special "construction key" is canceled out by removal of the key block. A key block removal tool is furnished with the Master keys for the locks. Simply push the removal tool into the keyway, then withdraw it to remove the block.

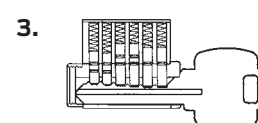













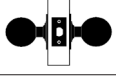



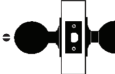

#### 3. Change or master key use

Cylinder is now only operable by the regular change key or Master key.

## Functions

# Cylindrical and unit lock functions

These pages contain the ordering function codes for Falcon locks on a cylindrical design which includes the RU Series unit lock. A cylindrical lock, also referred to as a bored lock, is a lock in which a large hole is bored into the door face of a door and a smaller cross-bore hole is bored into the door edge. These locks fit a variety of applications and can be Grade 1 or Grade 2. The unit lock is designed specifically for retrofitting older and historical buildings where doors have an existing prep cut or drilled for an old-fashioned lock design.

Function	Unit		Cylindrical		SFIC	Name	Description
	Unit lock	Lever	Knob				
101	ANSI F36 RU 	ANSI F75 T, K, B, W <sup>2</sup> 	W 			Passage/closet latch	Latch bolt operated by levers/knobs from either side at all times.
161		ANSI F111 B, W <sup>2</sup> 				Communicating/exit set	Latch bolt operated by inside lever/knob. Non-removable blank plate outside. Inside lever/knob always free for immediate egress.
201		ANSI F77 W 				Patio lock	Latch bolt operated by levers. Outside lever is locked by push button from inside. Rotating inside lever or closing door releases button and unlocks outside lever. Inside lever always free for immediate egress.
291		T 				Privacy hospital lock	Latch bolt operated by levers from either side. Outside lever locked by push button on inside lever. Rotating inside lever, closing door, or turning emergency release turn button on outside releases button. Inside lever always free for immediate egress.
301	ANSI F37 RU 	ANSI F76 T, K, B, W <sup>2</sup> 	ANSI F76 W 			Bath/bedroom privacy lock	Latch bolt operated by levers/knobs from either side. Outside locked by push button on inside lever/knob. Rotating inside lever/knob or closing door releases button. Emergency release tool used on outside unlocks door. Inside lever/knob always free for immediate egress.
341		B 				Communicating store room lock	Latch bolt operated by inside lever except when locked by key. Non-removable blank plate outside.
351		T 		Y		Closet lock	Latch bolt operated by lever/turn knob from either side except when outside lever is locked by key.
381	ANSI F45 RU 	ANSI F88 T 			Y	Classroom security lock	Latch bolt operated by levers from either side except when outside lever is locked from inside or outside by key. Unlock by key outside or by operating inside lever. Inside lever always free for immediate egress.
411	RU 	ANSI F87 T 			Y	Asylum lock <sup>1</sup>	Latch bolt operated by key from either side. Both levers/knobs always inoperable.
501	ANSI F41 RU 	ANSI F82 T, K, B, W 	ANSI F82 W 	Y		Entry lock	Latch bolt operated by levers/knobs from either side. Push button locking. Button on inside locks outside lever/knob until unlocked by key outside or by rotating inside lever/knob. Inside always free for immediate egress.

Function note: This lock will stay locked when the door is closed. If you want your door to unlock when it closes, please purchase the 571 function.



















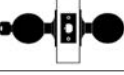

1. Caution: Double cylinder locks on residences and any door, in any structure, which is used for egress are a life safety hazard in times of emergency and their use is not recommended. Installation should be in accordance with existing codes only.

2. W Series lock levers available with small rose.

3. In the W Series you cannot lock from outside using key, locking function inside only.

## Functions

# Cylindrical and unit lock functions

Function	Unit		Cylindrical		SFIC	Name	Description
	Unit lock	Lever	Knob				
511	ANSI F40/F41 RU	ANSI F109 T, K, B, W <sup>2</sup>	ANSI F109 W		Y	Entry/office lock	Turn/push button locking: Pushing and turning button locks outside lever/knob requiring use of key until button is manually unlocked. Push button locking: Pushing button locks outside lever/knob until unlocked by key or by rotating inside lever. Inside lever always free for immediate egress. Latch bolt operated by levers/knobs. Key enables only unlocking from outside.
							
521	ANSI F40 RU	ANSI F81 T			Y	Office lock	Turn button locking. Turning button locks outside lever/knob requiring use of key until button is manually unlocked. Latch bolt operated by levers/knobs. Key enables only unlocking from outside. Inside always free for immediate egress.
							
561	ANSI F42 RU	ANSI F84 T, K, B, W <sup>2</sup>	ANSI F84 W		Y	Classroom lock	Latch bolt operated by levers/knobs. Outside lever is locked by key in outside lever/knob. Inside always free for immediate egress.
							
571 (order as 611 for B Series)	ANSI F48 RU	ANSI F90 T, K, B, W <sup>2,3</sup>	ANSI F90 W <sup>3</sup>		Y	Dormitory/ corridor lock	Latch bolt operated by levers/knobs except when locked by push button from inside. Key in outside lever/knob locks or unlocks lever/knob and releases button. Closing door releases push button. Inside always free for immediate egress.  Function note: This lock will unlock when the door is closed. If you want your door to remain locked when it closes, please purchase the 501 function.
							
581	ANSI F44 RU	ANSI F86 T, K, B, W <sup>2</sup>	ANSI F86 W		Y	Storeroom lock	Latch bolt operated by lever/knob inside or key outside. Outside lever/knob is inoperable. Inside always free for immediate egress.
							
711		W	W			Apartment entrance lock	Latch bolt operated by levers/knobs. Turn/push button locking: Pushing and turning button locks outside lever/knob requiring use of a key for unlocking the door until button is manually unlocked. Push button locking: Pushing button locks outside lever until unlocked by key, by rotating inside lever, or by closing the door. Inside always free for immediate egress.
							
851	RU	T			Y	Storeroom (electrified-fail safe)	Latch bolt operated by lever from either side except when outer lever is electrically locked. When outer lever is locked (inoperable), latch bolt retracted by key in cylinder outside. Inside lever always free for immediate egress.  Note: Specify 12V (.65 Amps) or 24V (.32 Amps) DC, continuous duty.
							
881	RU	T			Y	Storeroom (electrified-fail secure)	Latch bolt operated by lever inside except when outer lever is electrically unlocked, then latch bolt from either side. When locked, key in cylinder outside retracts latch bolt. Inside lever always free for immediate egress.  Note: Specify 12V (.65 Amps) or 24V (.32 Amps) DC, continuous duty.
							
12		T, K, B, W <sup>2</sup>	W			Dummy trim	Single trim, surface-mounted rigid lever/knob. Double dummy trim available for W Series (levers only).
							

# T Series

Grade 1, extra heavy-duty cylindrical lever locks

Simply put, the Falcon T Series lock is the most versatile lockset in the industry. This extra heavy-duty lock can accept most manufacturer's cylinders. Designed with compression springs in the spring cages, T Series virtually eliminates lever sag for long lasting performance. This adaptable lock is well suited for either new construction or retrofit use in buildings as varied as multi-family, retail, institutional and government/military.

## Features

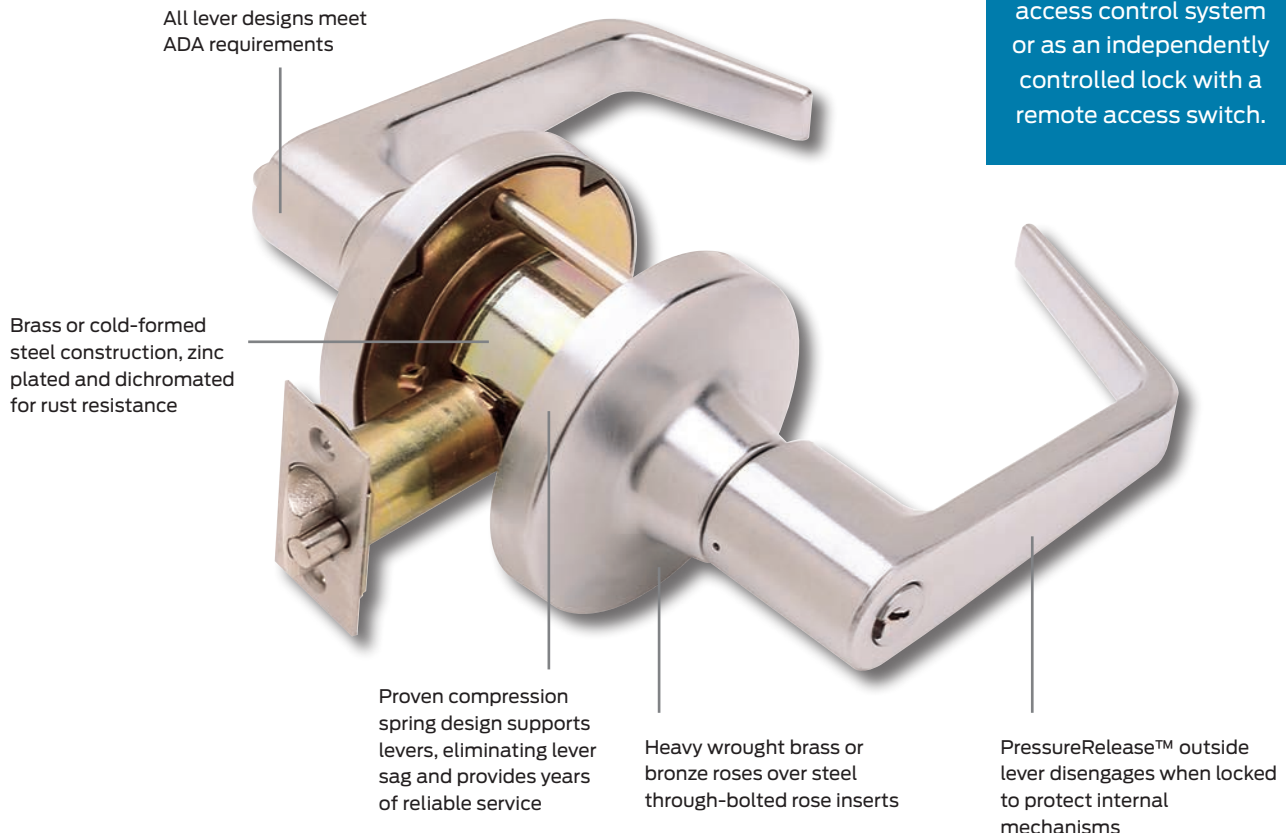

T Series lock is also available electrified for use in a wired access control system or as an independently controlled lock with a remote access switch.

## Specifications

# T Series

### Product specifications

**ANSI/BHMA:** Certified ANSI/BHMA A156.2, Series 4000, Grade 1.

**UL:** Listed for 3-hour fire door, A label.

**Functions:** 13 mechanical and 2 electrified (24 VDC .185 Amp) commercial functions available. See page 10 for details.

**Finishes:** 8 options available. See page 6 for finish color and comparative chart.

**Door thickness:** 1 3/4" to 2 1/4" standard. Thin door adapter kit (A30775-000-00) available for doors 1 3/8" to 1 3/4", please specify door thickness.

**Backset:** 2 3/4" standard. 2 3/8", 3 3/4" and 5" also available (see price book).

**Mechanism:** Parts constructed of brass or cold formed steel, zinc plated and dichromated for rust resistance. Springs are stainless steel. compression spring design supports levers, eliminating lever sag and providing years of reliable service.

**Attachment:** Lock chassis secured to door by threaded mounting nuts. Preassembled outer trim and inner spindle assembly are through-bolted over chassis using two (2) 10-32 screws. Adding rose and lever to inner spindle assembly completes installation.

**Handing:** Locks are non-handed.

**Cylinders:** Conventional cylinder, drilled with 6-pin chambers, pinned in 5 comes standard. Pinning in 6 chambers available (at no cost) when specified. Optional 7-pin conventional and 6- or 7-pin Small Format Interchangeable Core (SFIC) cylinders. Cylinder housings and plugs machined from solid brass. Springs are phosphor bronze. Two nickel silver keys furnished standard. See SFIC cylinder information on page 8 and T Series cylinder pages for additional options.

**Keyways:** "G" keyway standard on conventional cylinders. "A" keyway standard on SFIC cylinders. Additional options: Falcon, Schlage and many Best and Arrow keyways.

**Trim:** Roses are heavy wrought brass or bronze, installed over pressure cast rose inserts which are through-bolted. Levers are pressure cast (solid levers—no inserts) material finished to match mating parts.

**Latches:** 1/2" bolt projection, UL listed with square corner latch faceplate 2 1/4" x 1 1/8" standard. See options section for more latches.

**Strikes:** 4 7/8" x 1 1/4" ANSI strike with curved lip to meet ANSI A115.2 door frame preparation standard.

**Screws:** Furnished with combination screws for use in wood or metal doors and frames.

### Architectural specifications

Key-in-lever cylindrical locksets shall be Falcon lock T Series or equal and meet the following requirements:

- All locks shall meet the ANSI/BHMA A156.2, Series 4000, Grade 1 for key-in-lever locksets.
- Locksets shall be UL Listed (3 hour A Label).
- Locksets shall be provided standard with a clutching lever design. When outside lever is locked, it is not rigid but will move freely without operating the latch bolt.
- Lever trim shall have individual heavy-duty compression springs behind rose for lever return and to prevent lever sag. Trim shall be through-bolted with two (2) 10-32 screws coated with thread sealant to provide strength and resistance to loosening. Inner and outer trim shall "bottom out" to prevent door collapse. Roses shall be minimum of 3 1/2" diameter.
- All lever designs shall be solid and meet the federal ADA and state disability requirements. Inside levers shall be attached by Allen-head set screw to prevent tampering or vandalism.
- Locksets shall adjust to fit door thickness from 1 3/4" to 2 1/8".
- All locksets shall be non-handed and not require field disassembly for re-handing.
- Preparation for door must be non-handed.
- Acceptable manufacturer: Falcon lock

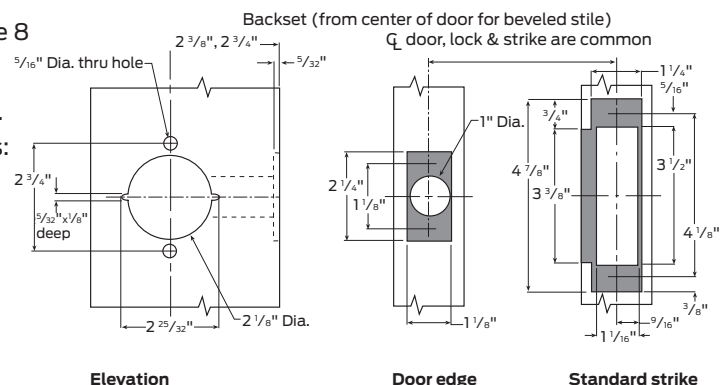

## Designs and styles

# Lever styles

Levers are solid pressure cast zinc, finished to match mating parts. Roses are wrought brass or bronze installed over steel, through-bolted rose inserts. Pressure Release™ levers are standard. Levers are secured by a spring-loaded retainer. Retainer cannot be depressed when locks have been locked.

Avalon (A)



Boardwalk (BRK)

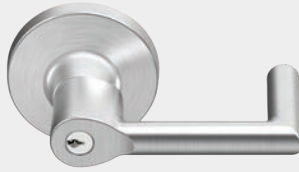

Broadway (BRW)

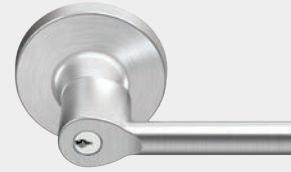

Dane (D)



Latitude (LAT)

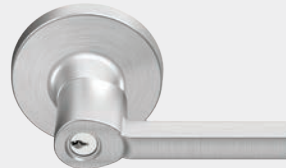

Longitude (LON)

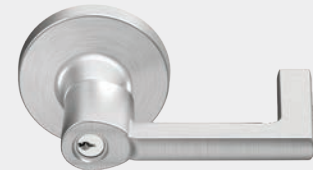

Quantum (Q)

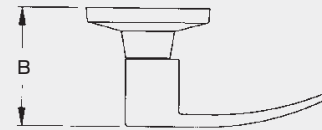
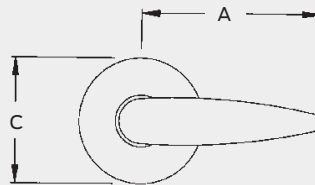

### Abrasive strip levers

Avalon, Dane, and Quantum levers are available with an abrasive strip along the inside length of the lever to identify entrances that may be to areas hazardous to the handicapped. To order, preface the design code with a 6 (example: 6DA for Dane). Not available on 613 finish as abrasive strip will not hold.

### Finishes

Available in BHMA 605, 606, 613, 619, 622, 625, 626, and 643e. See page 6 for finish color and comparative chart.

### Lever dimensions chart

Lever	A - width	B - projection	C - rose
Avalon (A)	5"	3 1/4"	3 1/2"
Boardwalk (BRK)	5"	3 7/8"	3 1/2"
Broadway (BRW)	4 1/2"	3 7/8"	3 1/2"
Dane (D)	5"	3 1/4"	3 1/2"
Latitude (LAT)	4 1/2"	3 7/8"	3 1/2"
Longitude (LON)	5"	3 7/8"	3 1/2"
Quantum (Q)	5"	3 1/4"	3 1/2"

Note: Return to door meets 1/2" requirement for Dane (D), Quantum (Q), Boardwalk (BRK) and Longitude (LON) levers.

## Cylinders

## T Series cylinders

**Falcon Small Format Interchangeable Core (SFIC) cylinders**

Falcon offers a wide selection of keyways in SFIC cylinder formats. Master keying is available and, in most cases, Falcon can even furnish cores master keyed into existing Best or Arrow key systems. See page 8 for details.

**Conventional cylinders (Falcon keyways)**

5-Pin cylinder	6-Pin cylinder	7-Pin cylinder	Function
A23151-05	A23161-05	A23171-05	All except 381 I/S, 571
A23151-06	A23161-06	A23171-06	381 Inside cylinder
A23151-07	A23161-07	A23171-07	571

Note: The "G" keyway is standard and will be supplied unless otherwise specified. Master keying is available for 2, 3, and 4 levels. Open keyways include E, H, K, L, and P. If ordering cylinders as parts, specify finish: 606, 622 or 626.

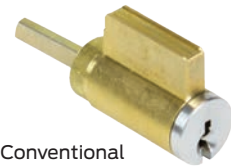

Conventional cylinder

**To order conventional cylinders in competitive keyways (6-pin)**

When specifying a competitive cylinder, reference the How-to-order page for correct cylinder suffix and be sure to list brand plus keyway under the "Keyway" section and the correct part number from the list below in the "Additional Details" area of the part number order string.

Brand	Keyway	O-Bit	KA	KD	Lock function
Corbin	60	A23167-000	-	A23167-0KD	All except 571 and 381(I/S)
		A23167-011	A23167-11A	A23167-11D	381(I/S)
		A23167-012	A23167-12A	A23167-12D	571
Corbin Russwin	L4	A23174-000	A23174-0KA	-	All except 571 and 381(I/S)
		A23174-011	A23174-11A	-	381(I/S)
		A23174-012	-	-	571
Russwin	D1	A23168-000	-	A23168-0KD	All except 571 and 381(I/S)
		A23168-011	-	A23168-11D	381(I/S)
		A23168-012	-	A23168-12D	571
Sargent	LA	A23166-000	-	A23166-0KD	All except 571 and 381(I/S)
		A23166-011	-	A23166-11D	381(I/S)
		A23166-012	-	A23166-12D	571
Schlage	C	A23160-000	A23160-0KA	A23160-0KD	All except 571 and 381(I/S)
		A23160-011	A23160-11A	A23160-11D	381(I/S)
		A23160-012	A23160-12A	A23160-12D	571
	E	A23159-000	-	-	All except 571 and 381(I/S)
		A23159-011	-	-	381(I/S)
A23159-012	-	-	571		
Yale	8 (Para)	A23169-000	-	A23169-0KD	All except 571 and 381(I/S)
		A23169-011	-	A23169-11D	381(I/S)
		A23169-012	-	A23169-12D	571

Note: Competitor keyways are furnished 0 bitted, unless otherwise specified. Not available Master keyed, except Schlage C. KD option is not available for locks containing 2 cylinders.

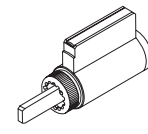

T381 Inside

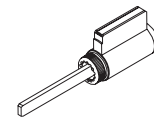

T571

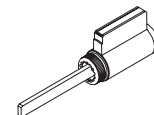

T Series  
All other functions

## Cylinders

## T Series compatible cylinders

## Reference chart for locks ordered less cylinder

Falcon offers many "less cylinder" options for when you need a quality lock to fit into an existing key system. For levers prepared to fit competitive key systems, please reference the lists below. A proper tailpiece is supplied with the lock unless otherwise noted.

Conventional cylinders	Full Size IC	Unit/Mono locks
Assa 65611 and 65661, 6-pin <sup>1</sup>	Assa 70600IC and V70600IC, 6-pin	
Corbin Russwin 2000-034 and CL3400, 6-pin (master ring not available) <sup>1</sup>	Corbin Russwin 8000, 6-pin and 8000-7, 7-pin	Corbin Russwin, 2000-052 (master ring not available)
Medeco 20W200V3, 6-pin (Falcon/Schlage style) <sup>1</sup>	Medeco 31 Series, 6-pin and 32 Series, 7-pin	Medeco 20W5005 retrofit cylinder for Corbin Russwin unit lock Medeco 20W0500 retrofit cylinder for Yale 6200 unit lock
Peaks (Kaba), 6-pin <sup>1</sup>	Peaks (Kaba), 6- and 7-pin	
Sargent 6, 7, and 10 Line, 6-pin (Keso not available)	Sargent 6300, 6-pin	
Schlage Classic and Primus, 6-pin <sup>1</sup>	Schlage Classic and Primus, 6-pin	Falcon conventional, 6-pin (R Series old small plug)
Yale 1810, 6-pin (Bicentric not available)	Yale 1210, 6-pin	Yale 1801 mono lock and later models

1. Tailpiece not supplied.



Options

# Latches

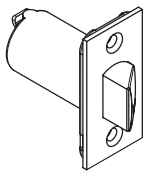

Springlatch

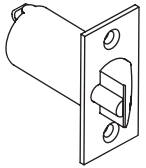

Deadlatch

**Grade 1, UL listed**

	Specify	Backset	Description
Springlatch	23981111	2 3/8"	Square corner, 1" x 2 1/4"
	23981137	2 3/4"	Square corner, 1 1/8" x 2 1/4", standard
	24074387	3 3/4"	Square corner, 1 1/8" x 2 1/4"
Deadlatch	23981160	2 3/8"	Square corner, 1" x 2 1/4"
	23981145	2 3/4"	Square corner, 1 1/8" x 2 1/4", standard
	23981152	2 3/4"	Anti-friction fire door latch Square corner, 1 1/8" x 2 1/4", 3/4" throw
	23981129	3 3/4"	Square corner, 1 1/8" x 2 1/4"
	43-005	5"	Backset extension link

Note: Specify finish 606, 613 or 630. All latches for T Series locks are UL listed and have a 1/2" bolt projection.

# Strikes

Locks furnished with a 1 1/4" x 4 7/8" ANSI Strike unless otherwise specified.  
Optional 1" deep ANSI steel dust box also available. Specify 005099-000-30.

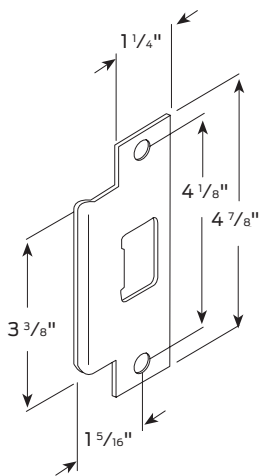

**5164**  
ANSI prep A115.2  
(standard)<sup>1</sup>

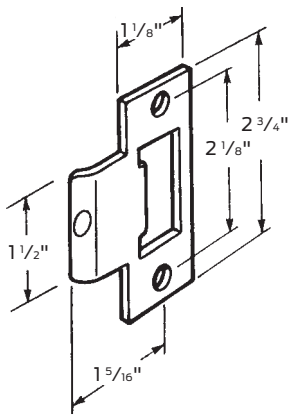

**5185**  
T-strike square corner

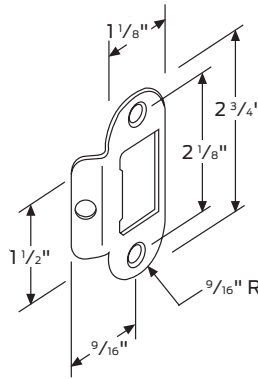

**5185-4**  
T-strike 9/16" radius

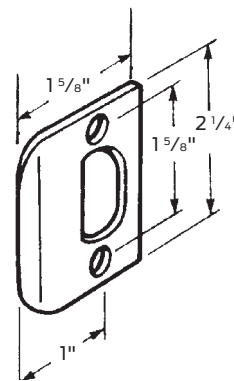

**01-049**  
Full lip, square corner

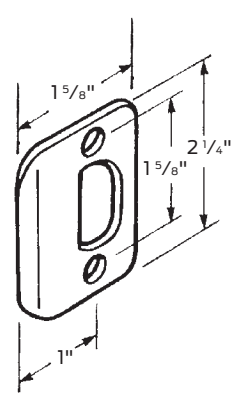

**01-048**  
Full lip, 1/4" radius corner

1. For ANSI prep with 7/8" lip length order 5161.

# K Series

Grade 1 cylindrical lever locks

High traffic, high abuse door openings demand a Grade 1 quality lock to keep doors secure. When quality and reliability are needed but cost is a concern, the certified ANSI/BHMA Grade 1 Falcon K Series can do the job. The Falcon K Series gets back to basics by offering the most common functions, lever styles and finishes at an affordable price. The K Series features conventional cylinders and small format interchangeable cores that are compatible with SFIC products from other manufacturers. Conventional cylinders are available in all Falcon conventional key sections, as well as Schlage C keyway, which is now master keyed across the complete Falcon product line.

## Features

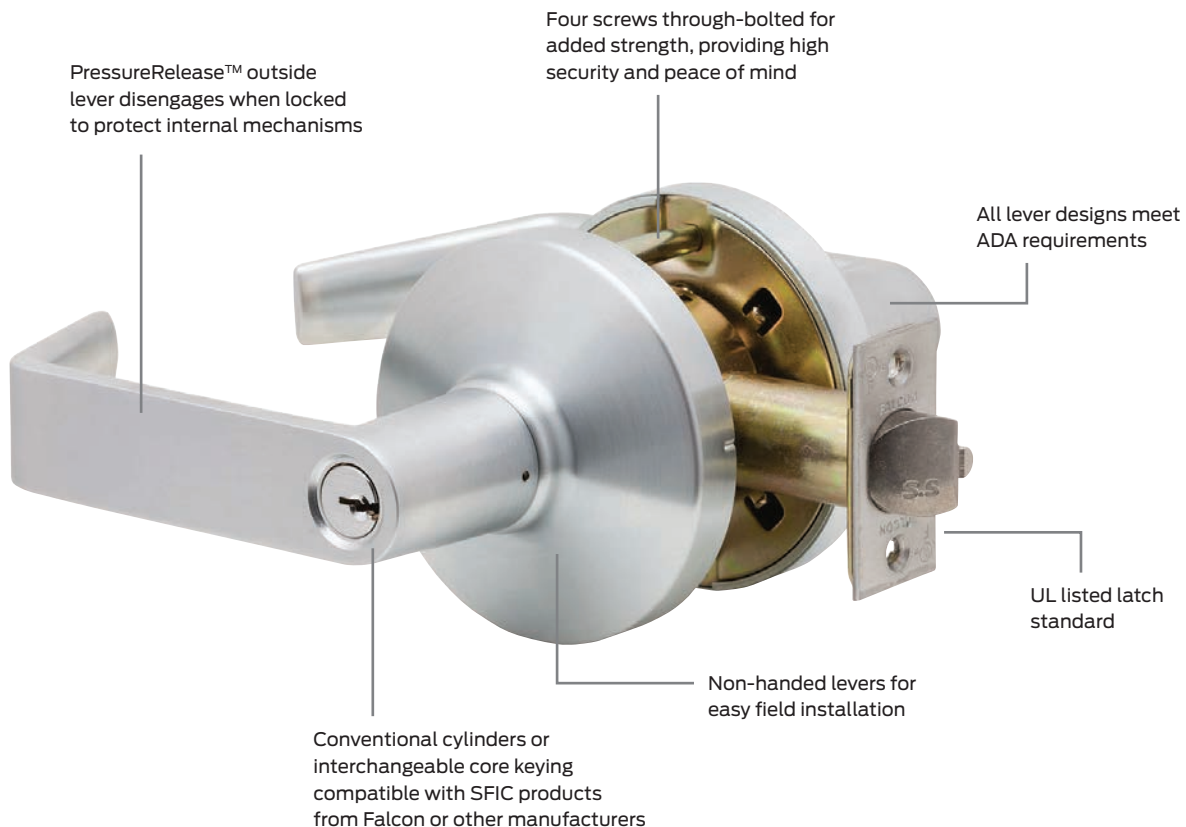

## Specifications

# K Series

### Product specifications

**ANSI/BHMA:** Certified ANSI/BHMA A156.2, Series 4000, Grade 1.

**UL:** Listed for 3-hour fire door, A label.

**Functions:** 8 commercial functions available. See page 10 for details.

**Finishes:** 2 options available. See page 6 for finish color and comparative chart.

**Door thickness:** Adjustable 1 <sup>3</sup>/<sub>8</sub>" to 2 <sup>1</sup>/<sub>4</sub>". Comes set for a 1 <sup>3</sup>/<sub>4</sub>" thick door standard.

**Backset:** 2 <sup>3</sup>/<sub>4</sub>" standard. 2 <sup>3</sup>/<sub>8</sub>" optional.

**Mechanism:** Parts constructed of brass or cold formed steel, zinc plated and dichromated for rust resistance. Springs are stainless steel.

**Attachment:** Lock chassis secured to door by threaded mounting screws. Completely preassembled outer trim and inner spindle assembly are through-bolted both through and over chassis using four (4) screws to provide strength and resistance to loosening. Adding rose and lever to inner spindle assembly completes installation.

**Handing:** Locks are non-handed.

**Cylinders:** Conventional cylinder, drilled with 6-pin chambers, pinned in 5 comes standard. Pinning in 6 chambers available (at no cost) when specified. Optional 7-pin conventional and 6- or 7-pin Small Format Interchangeable Core (SFIC) cylinders. Cylinder housings and plugs machined from solid brass. Springs are phosphor bronze. Two nickel silver keys furnished standard. See SFIC cylinder information on page 8 and K Series cylinder pages for additional options.

**Keyways:** "G" keyway standard on conventional cylinders. "A" keyway standard on SFIC cylinders. Additional options: Falcon, Schlage and many Best and Arrow keyways.

**Trim:** Roses are heavy wrought brass or bronze, installed over pressure cast rose inserts which are through-bolted through door. Levers are pressure cast (solid levers—no inserts) material finished to match mating parts.

**Latches:** 2 <sup>1</sup>/<sub>4</sub>" x 1 <sup>1</sup>/<sub>8</sub>" square corner with 2 <sup>3</sup>/<sub>4</sub>" backset comes standard; 2 <sup>3</sup>/<sub>8</sub>" backset option available if specified. Radius corners for both 2 <sup>3</sup>/<sub>8</sub>" and 2 <sup>3</sup>/<sub>4</sub>" backsets available if specified. All latches are UL listed and conform to both beveled and non-beveled doors.

**Strikes:** 4 <sup>7</sup>/<sub>8</sub>" x 1 <sup>1</sup>/<sub>4</sub>" ANSI strike with curved lip to meet ANSI A115.2 door frame preparation standard.

**Screws:** Furnished with combination screws for use in wood or metal doors and frames.

### Architectural specifications

Key-in-lever cylindrical locksets shall be Falcon lock K Series or equal and meet the following requirements:

- All locks shall meet the ANSI/BHMA A156.2, Series 4000, Grade 1 for key-in-lever locksets.
- Locksets shall be UL Listed (3 hour A Label).
- Locksets shall be provided standard with a clutching lever design. When outside lever is locked, it is not rigid but will move freely without operating the latch bolt.
- Lever trim shall have individual torsion springs behind rose for lever return and to prevent lever sag. Trim shall be through bolted with four (4) screws to provide strength and resistance to loosening. Inner and outer trim shall "bottom out" to prevent door collapse. Roses shall be minimum of 3 <sup>1</sup>/<sub>2</sub>" diameter.
- All lever designs shall be solid and meet the federal ADA and state disability requirements. Inside levers shall be attached by allen-head set and lever catch to prevent tampering or vandalism.
- Locksets shall adjust to fit door thickness from 1 <sup>3</sup>/<sub>8</sub>" to 2 <sup>1</sup>/<sub>4</sub>".
- All locksets shall be non-handed and not require field disassembly for re-handing.
- Preparation for door must be non-handed.
- Cylinders to be secured by a dual retainer.
- Acceptable manufacturer: Falcon Lock

## Designs and styles

# Lever styles

Levers are solid pressure cast zinc, finished to match mating parts. Roses are wrought brass or bronze installed over steel, through-bolted rose inserts. Pressure Release™ levers are standard. Levers are secured by a spring-loaded retainer. Retainer cannot be depressed when locks have been locked.

### Avalon

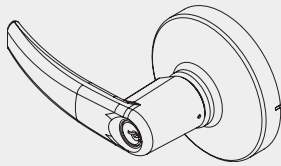

### Dane

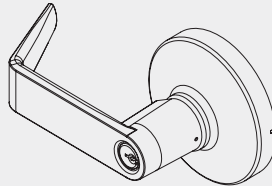

### Quantum

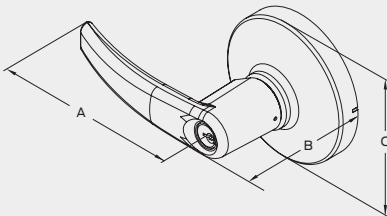
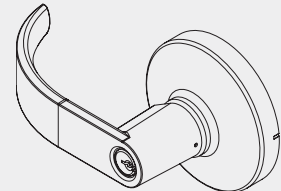

### Lever dimensions chart

Lever	A - width	B - projection	C - rose
Avalon (A)	4 1/2"	3 1/8"	3 1/2"
Dane (D)	5"	3 1/8"	3 1/2"
Quantum (Q)	5"	3 1/8"	3 1/2"

Note: Return to door meets 1/2" requirement for Dane (D) and Quantum (Q) levers.

### Finishes

Available in BHMA 613 and 626. See page 6 for finish color and comparative chart.

## Cylinders

# K Series cylinders

### Falcon Small Format Interchangeable Core (SFIC) cylinders

Falcon offers a wide selection of keyways in SFIC cylinder formats. Master keying is available and, in most cases, Falcon can even furnish cores master keyed into existing Best or Arrow key systems. See page 8 for details.

### Conventional cylinders (Falcon keyways)

Catalog number	Description
Q330-396	Falcon cylinder, G keyway, 6 pin
Q330-397	Falcon cylinder, G keyway, 6 pin to 5 pin
Q630-310	Falcon cylinder, G keyway, 6 pin, K571
Q630-311	Falcon cylinder, G keyway, 6 pin to 5 pin, K571
Q330-391	Schlage cylinder, C keyway, 6 pin
Q630-306	Schlage cylinder, C keyway, 6 pin, K571

Note: Specify finish: 606 or 626



Conventional cylinder

### To order conventional cylinders in competitive keyways (6-pin)

When specifying a competitive cylinder, reference How-to-order page for correct cylinder suffix and be sure to list brand plus keyway under the "Keyway" section and the correct part number below in the "Other Requirements" area of the part number order string.

Brand	Keyway	O-bit	KA	KD	Lock function
Corbin	60	Q330-166	-	Q330-166-KD	All except 751
Corbin Russwin	L4	Q330-158	-	Q330-158-KD	All except 751
Russwin	D1	Q330-210	-	Q330-210-KD	All except 751
Sargent	LA	Q330-160	-	Q330-160-KD	All except 751
Schlage	C	Q330-152	Q330-152-KA	Q330-152-KD	All except 751
Yale	8 (Para)	Q330-156	-	Q330-156-KD	All except 751

Note: Construction keying available. Reference page 9 for more information.

Options

# Latches

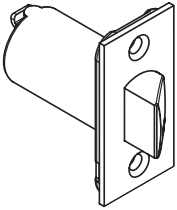

1/2" projection

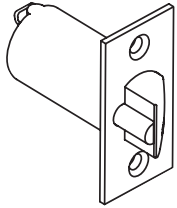

1/2" projection

**Grade 1, UL listed**

	Specify	Backset	Function(s)	Description
Springlatch	30-271	2 3/8"	301	Square corner, 1 1/8" x 2 1/4"
	30-273	2 3/8"	301	Radius corner, 1 1/8" x 2 1/4"
	30-270	2 3/4"	301	Square corner, 1 1/8" x 2 1/4", standard
	30-272	2 3/4"	301	Radius corner, 1 1/8" x 2 1/4"
	30-267	2 3/8"	101	Square corner, 1 1/8" x 2 1/4", non-restoring
	30-269	2 3/8"	101	Radius corner, 1 1/8" x 2 1/4", non-restoring
	30-266	2 3/4"	101	Square corner, 1 1/8" x 2 1/4", non-restoring
	30-268	2 3/4"	101	Radius corner, 1 1/8" x 2 1/4", non-restoring
Deadlatch	30-386	2 3/8"	571	Square corner, 1 1/8" x 2 1/4"
	30-388	2 3/8"	571	Radius corner, 1 1/8" x 2 1/4"
	30-385	2 3/4"	571	Square corner, 1 1/8" x 2 1/4", standard
	30-387	2 3/4"	571	Radius corner, 1 1/8" x 2 1/4"
	30-301	2 3/8"	501, 511, 561, 581	Square corner, 1 1/8" x 2 1/4", non-restoring
	30-275	2 3/8"	501, 511, 561, 581	Radius corner, 1 1/8" x 2 1/4", non-restoring
	30-302	2 3/4"	501, 511, 561, 581	Square corner, 1 1/8" x 2 1/4", non-restoring
	30-274	2 3/4"	501, 511, 561, 581	Radius corner, 1 1/8" x 2 1/4", non-restoring

Note: Specify finish 613 or 626. All latches for K Series locks are UL listed and have a 1/2" bolt projection. They conform to both beveled and non-beveled doors.

# Strikes

Locks furnished with a 1 1/4" x 4 7/8" ANSI Strike unless otherwise specified.

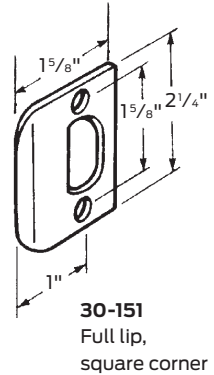
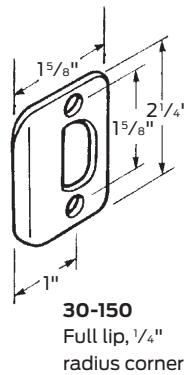
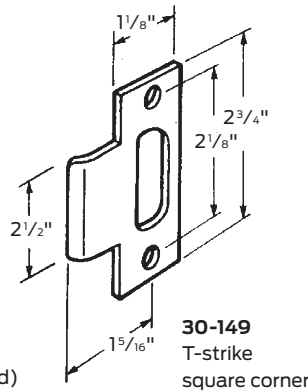
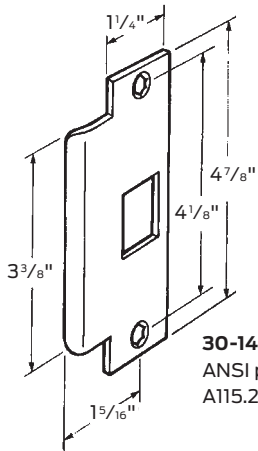

This page is intentionally left blank.

# B Series

Grade 2, medium-duty cylindrical lever locks

When you need a tough, reliable lock at the right price point for a retail, industrial or multi-family project, you need a Falcon B Series lock. Our full line of Grade 2 locksets are a perfect replacement for existing locks, or a smart specification in new construction. With upgraded finishes, these locks deliver style as well as strength. Falcon B Series lock options include an interchangeable core that can be removed for quick, easy re-keying, and are compatible with SFIC products from other manufacturers. Most importantly, they're backed by one of the best names in the business.

## Features

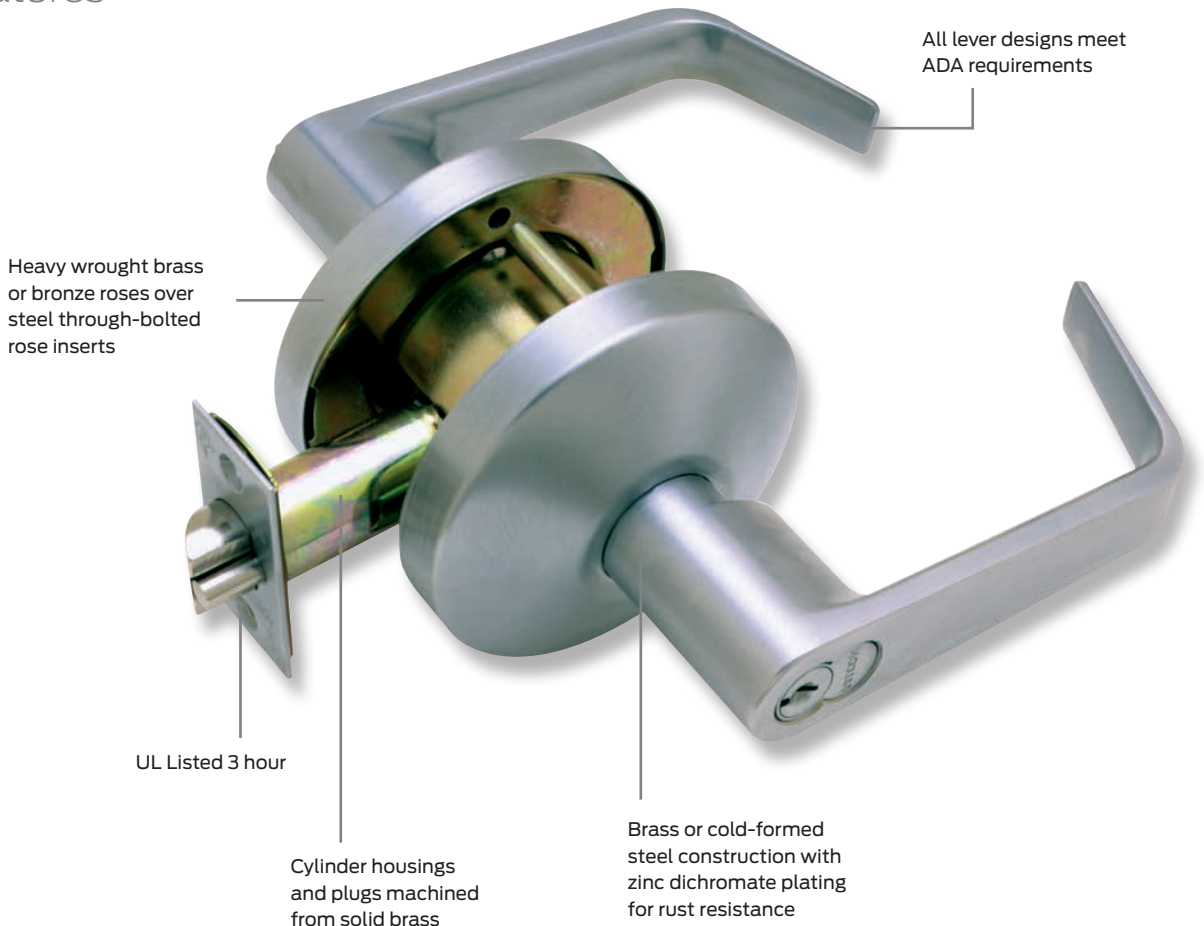



## Specifications

# B Series

### Product specifications

**ANSI/BHMA:** Certified ANSI/BHMA A156.2, Series 4000, Grade 2.

**UL:** Listed for 3-hour fire door, A label.

**Functions:** 10 commercial functions available. See page 10 for details.

**Finishes:** 5 options available. See page 6 for finish color and comparative chart.

**Door thickness:** 1 <sup>3</sup>/<sub>8</sub>" to 2" standard. See price book for exceptions on communicating lock functions.

**Backset:** 2 <sup>3</sup>/<sub>4</sub>" standard. 2 <sup>3</sup>/<sub>8</sub>" and 5" also available (see price book).

**Mechanism:** Parts constructed of brass or cold formed steel, zinc plated and dichromated for rust resistance. Springs are stainless steel.

**Attachment:** Lock chassis secured to door by two screws which pass through a steel rose insert inside and thread directly into the outer rose mounting assembly.

**Handing:** Locks are non-handed.

**Cylinders:** Conventional cylinder, drilled with 6-pin chambers, pinned in 5 comes standard. Pinning in 6 chambers available (at no cost) when specified. Optional 7-pin conventional and 6- or 7-pin Small Format Interchangeable Core (SFIC) cylinders. Cylinder housings and plugs machined from solid brass. Springs are phosphor bronze. Two nickel silver keys furnished standard. See SFIC cylinder information on page 8 and B Series cylinder pages for additional options.

**Keyways:** "G" keyway standard on conventional cylinders. "A" keyway standard on SFIC cylinders. Additional options: Falcon, Schlage and many Best and Arrow keyways.

**Trim:** Roses are 3 <sup>1</sup>/<sub>2</sub>" diameter, heavy wrought brass or bronze, installed over steel rose inserts which are through-bolted through door. Levers are pressure cast zinc (solid levers no inserts) material finished to match mating parts.

**Latches:** <sup>1</sup>/<sub>2</sub>" bolt projection. UL (3-hour, A Label) listed. Latches have self-adjusting fronts to accommodate beveled or flat doors. 2 <sup>3</sup>/<sub>8</sub>" backset with 2 <sup>1</sup>/<sub>4</sub>" x 1" latchfaces, 2 <sup>3</sup>/<sub>4</sub>" backset with 2 <sup>1</sup>/<sub>4</sub>" x 1 <sup>1</sup>/<sub>8</sub>" latchfaces. Deadlocking latches have a solid round bar stock DL bar preventing latch jamming and/or lock outs.

**Strikes:** 4 <sup>7</sup>/<sub>8</sub>" x 1 <sup>1</sup>/<sub>4</sub>" ANSI strike with curved lip to meet ANSI A115.2 door frame preparation standard.

**Screws:** Furnished with combination screws for use in wood or metal doors and frames.

### Architectural specifications

Key-in-lever cylindrical locksets shall be Falcon B Series or equal and meet the following requirements:

- All locks shall meet the ANSI/BHMA A156.2, Series 4000, Grade 2 test requirements for key-in-lever locksets.
- Locksets shall be UL Listed 3-hour, A Label.
- Lever trim shall have individual heavy-duty springs for lever return and to prevent lever sag. Trim shall be through-bolted with screws coated with thread sealant to provide strength and resistance to loosening.
- Roses shall be 3 <sup>1</sup>/<sub>2</sub>" diameter.
- All lever designs shall be solid (no inserts) and meet the federal ADA and state disability requirements.
- Locksets shall adjust to fit door thickness from 1 <sup>3</sup>/<sub>8</sub>" to 2".
- All locksets shall be non-handed and not require field disassembly for re-handing.
- Preparation for door must be non-handed.
- Acceptable manufacturer: Falcon lock

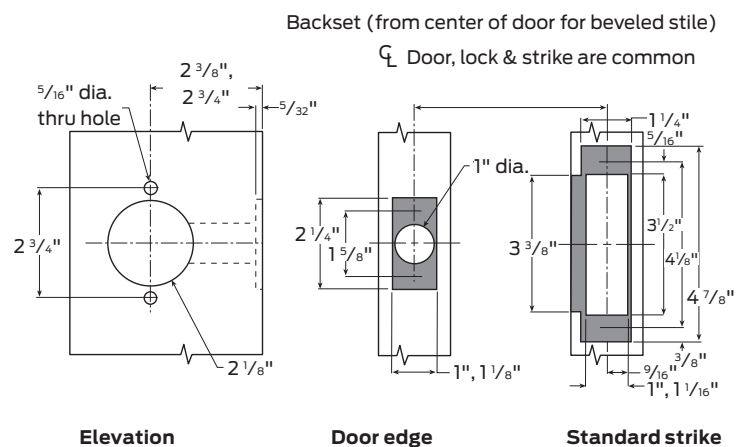

## Designs and styles

# Lever styles

Levers are solid pressure cast zinc, finished to match mating parts. Roses are wrought brass or bronze installed over steel, through-bolted rose inserts. Levers are secured by a spring-loaded retainer. Retainer in keyed lever cannot be depressed without key.

Dane (D)



Quantum (Q)

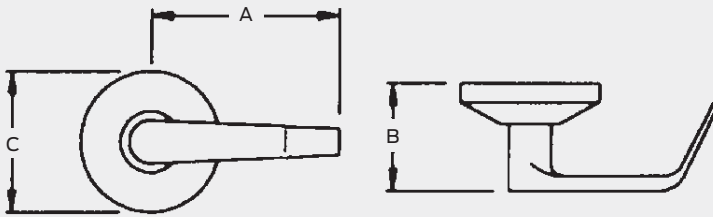

### Lever dimensions chart

Lever	A - width	B - projection	C - rose
Dane (D)	4 <sup>5</sup> / <sub>8</sub> "	2 <sup>5</sup> / <sub>8</sub> "	3 <sup>1</sup> / <sub>2</sub> "
Quantum (Q)	4 <sup>5</sup> / <sub>8</sub> "	2 <sup>5</sup> / <sub>8</sub> "	3 <sup>1</sup> / <sub>2</sub> "

Note: Return to door meets 1/2" requirement for Dane (D) and Quantum (Q) levers.

### Abrasive strip levers

All levers are available with an abrasive strip along the inside length of the lever to identify entrances that may be to areas hazardous to the handicapped. To order, preface the design code with a 6 (example: 6D for Dane). Not available on 613 finish as abrasive strip will not hold.

### Finishes

Available in BHMA 605, 606, 613, 625, and 626. See page 6 for finish color and comparative chart.

## Cylinders

# B Series cylinders

### Falcon Small Format Interchangeable Core (SFIC) cylinders

Falcon offers a wide selection of keyways in SFIC cylinder formats. Master keying is available and, in most cases, Falcon can even furnish cores master keyed into existing Best or Arrow key systems. See page 8 for details.

### Conventional cylinders (Falcon keyways)

Catalog number	Description
A23155-02	5-pin For use in all B Series except B611*
A23155-06	5-pin For use in B611*
A23165-02	6-pin For use in all B Series except B611*
A23165-06	6-pin For use in B611*

Note: The "G" keyway is standard and will be supplied unless otherwise specified.  
Master keying is available for 2, 3, and 4 levels. Open keyways include E, H, K, L, and P.  
If ordering cylinders as parts, specify finish: 606, 622 or 626.

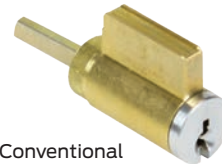

Conventional cylinder

### To order conventional cylinders in competitive keyways (6-pin)

When specifying a competitive cylinder, reference How-to-order page for correct cylinder suffix and be sure to list brand plus keyway under the "Keyway" section and the correct part number below in the "Other Requirements" area of the part number order string.

Brand	Keyway	O-Bit	KA	KD	Lock function
Corbin	60	A23167-013	-	A23167-13D	All except 611
		A23167-011	-	A23167-11D	611
Corbin Russwin	L4	A23174-013	-	-	All except 611
		A23174-011	-	-	611
Russwin	D1	A23168-013	-	A23168-13D	All except 611
		A23168-011	-	A23168-11D	611
Sargent	LA	A23166-013	-	A23166-13D	All except 611
		A23166-011	-	A23166-11D	611
Schlage	C	A23160-013	A23160-13A	A23160-13D	All except 611
		A23160-011	A23160-11A	A23160-11D	611
	E	A23159-013	-	-	All except 611
		A23159-011	-	-	611
Yale	8 (Para)	A23169-013	-	A23169-13D	All except 611
		A23169-011	-	A23169-11D	611

Note: Construction keying available. Reference page 9 for more information.

## Options

## Latches

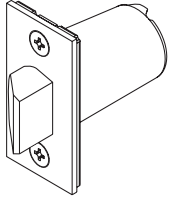

1/2" projection

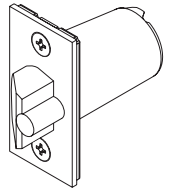

1/2" projection

## Grade 1, UL listed

Specify	Backset	Function(s)	Description
57635	2 3/4"	301, 611	Square corner, 1 1/8" x 2 1/4", standard
57630	2 3/4"	301, 611	Square corner, 1" x 2 1/4"
57631	2 3/4"	301, 611	Radius corner (1/4"), 1" x 2 1/4"
57625	2 3/8"	301, 611	Square corner, 1 1/8" x 2 1/4"
57620	2 3/8"	301, 611	Square corner, 1" x 2 1/4"
57621	2 3/8"	301, 611	Radius corner (1/4"), 1" x 2 1/4"
57435	2 3/4"	All other	Square corner, 1 1/8" x 2 1/4"
57430	2 3/4"	All other	Square corner, 1" x 2 1/4"
57431	2 3/4"	All other	Radius corner (1/4"), 1" x 2 1/4"
57425	2 3/8"	All other	Square corner, 1 1/8" x 2 1/4"
57420	2 3/8"	All other	Square corner, 1" x 2 1/4"
57421	2 3/8"	All other	Radius corner (1/4"), 1" x 2 1/4"
A31727-005-00	5"	All functions	Backset extension link (use with 2 3/8" backset latches only)

Note: Specify finish - springlatches: 605, 613 or 630; deadlatches: 605, 612, 613 or 630. All latches for B Series locks are UL listed and have a 1/2" bolt projection.

## Strikes

Locks furnished with a 1 1/4" x 4 7/8" ANSI Strike unless otherwise specified.  
Optional 1" deep ANSI steel dust box also available. Specify 005099-000-30.

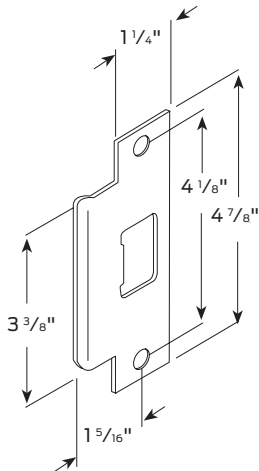

**5164**  
ANSI prep A115.2  
(standard)<sup>1</sup>

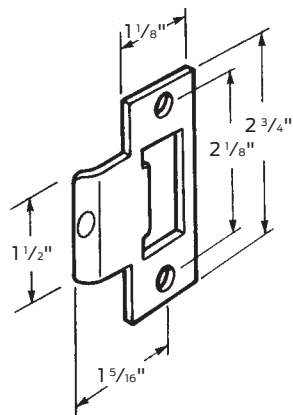

**01-046**  
T-strike square corner

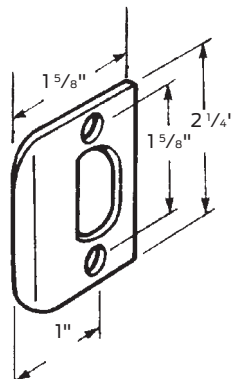

**01-049**  
Full lip, square corner

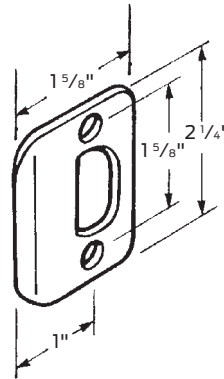

**01-048**  
Full lip, 1/4" radius  
corner

1. For ANSI prep with 7/8" lip length order 5161.

This page is intentionally left blank.

# W Series

Grade 2, medium-duty cylindrical lever and knob locks

Designed to offer more functions and finish options than other grade 2 locks, W Series has what you need at the right price. With seven popular lever styles along with two knob styles and your choice of rose diameters (large and small), Falcon W Series can match most commercial door trim. The Falcon W Series locks feature conventional cylinders and small format interchangeable cores that are compatible with SFIC products from other manufacturers. Our conventional cylinders are available in all Falcon conventional key sections as well as Schlage C keyway, which we now masterkey across the complete Falcon product line. The Falcon W Series offers quality product at a value price, and is backed by one of the best names in the business - Allegion.

## Features

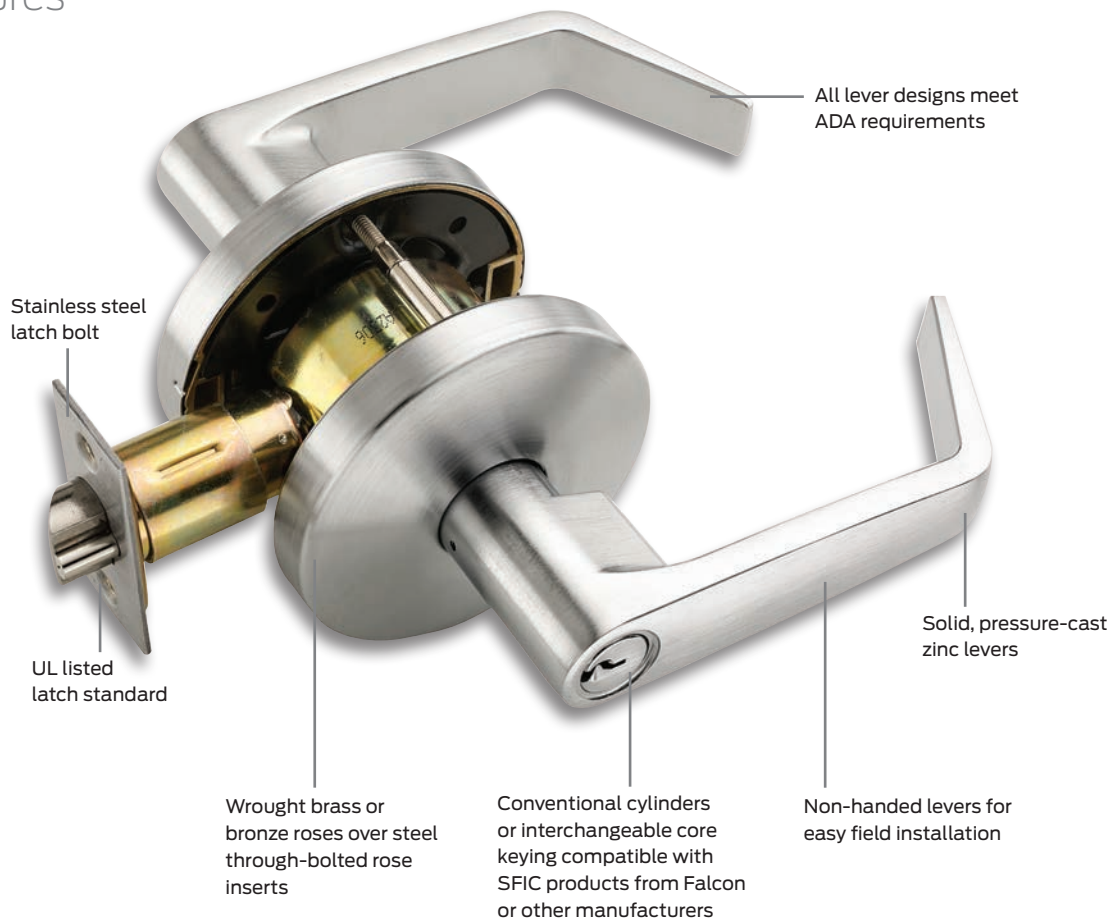

## Specifications

# W Series

### Product specifications

**ANSI/BHMA:** Certified ANSI/BHMA A156.2, Series 4000, Grade 2.

**UL:** Listed for 3-hour fire door, A label.

**Functions:** 11 commercial functions available. See page 10 for details.

**Rose size:** Standard rose diameter  $3\frac{3}{8}$ ". Small rose diameter  $2\frac{9}{16}$ ".

**Finishes:** 8 options available. See page 6 for finish color and comparative chart.

**Door thickness:**  $1\frac{3}{8}$ " to  $1\frac{3}{4}$ " standard.

**Backset:** Standard rose -  $2\frac{3}{4}$ " backset; Small rose -  $2\frac{3}{8}$ " backset.

**Mechanism:** Parts constructed of brass or cold-formed steel, zinc plated and dichromated for rust resistance. Springs are stainless steel.

**Attachment:** Lock chassis secured to door by two screws which pass through a steel rose insert inside and thread directly into the outer rose-mounting assembly, and two screws that screw into the chassis assembly.

**Handing:** Locks are non-handed.

**Cylinder:** Conventional cylinder, drilled with 6-pin chambers, pinned in 5 comes standard. Pinning in 6 chambers available (at no cost) when specified. Optional 7-pin conventional and 6- or 7-pin Small Format Interchangeable Core (SFIC) cylinders. Cylinder housings and plugs machined from solid brass. Springs are phosphor bronze. Two nickel silver keys furnished standard. See SFIC cylinder information on page 8 and W Series cylinder pages for additional options.

**Keyways:** "G" keyway standard on conventional cylinders. "A" keyway standard on SFIC cylinders. Additional options: Falcon, Schlage and many Best and Arrow keyways.

**Trim:** Roses are heavy wrought brass or bronze, installed over steel rose inserts which are through-bolted. Levers are pressure-cast zinc (solid levers-no-inserts) finished to match mating parts.

**Latches:**  $\frac{1}{2}$ " bolt projection made of stainless steel and UL listed for 3-hour door assemblies. Latches have self-adjusting fronts to accommodate beveled or flat doors. Standard rose:  $2\frac{3}{8}$ " backset with  $1$ " x  $2\frac{1}{4}$ " latch face or  $2\frac{3}{4}$ " backset with  $1\frac{1}{8}$ " x  $2\frac{1}{4}$ " latch face. Small rose:  $2\frac{3}{4}$ " backset with  $1\frac{1}{8}$ " x  $2\frac{1}{4}$ " latch face.

**Strikes:**  $4\frac{7}{8}$ " x  $1\frac{1}{4}$ " ANSI strike with curved lip to meet ANSI A115.2 door frame preparation standard. Consult Options and Accessories section for other available strikes, sizes and configurations.

**Screws:** Furnished with combination screws for use in wood or metal doors and frames.

### Architectural specifications

Key-in-lever cylindrical locksets shall be Falcon W Series or equal and meet the following requirements:

- All locks shall meet ANSI/BHMA A156.2, Series 4000, Grade 2 test requirements for key-in-lever locksets
- Locksets shall be UL Listed 3-hour, A Label
- Lever trim shall have individual, heavy-duty springs for lever return and to prevent lever sag; trim shall be through-bolted
- All lever designs shall be solid (no inserts) and meet the federal ADA and state disability requirements
- Locksets shall adjust to fit door thickness from  $1\frac{3}{8}$ " to  $1\frac{3}{4}$ "
- All locksets shall be non-handed and not require field disassembly for re-handing
- Preparation for door must be non-handed (Acceptable manufacturer: Falcon lock)

#### Standard rose template

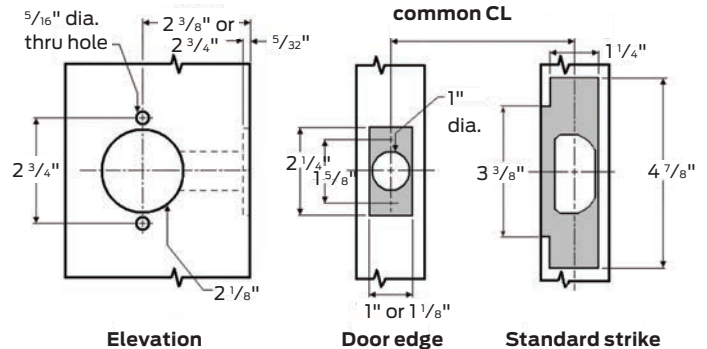

#### Small rose template

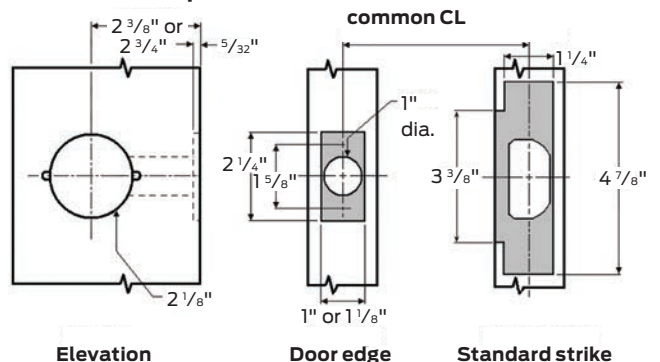

## Designs and styles

# Levers styles

Levers are solid pressure cast zinc, finished to match mating parts. Roses are wrought brass or bronze installed over steel through-bolted rose inserts. A spring-loaded retainer secures levers. Secure side retainer cannot be depressed without a key that operates the lock.

Avalon (A)

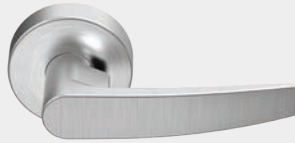

Boardwalk (BRK)



Broadway (BRW)



Dane (D)

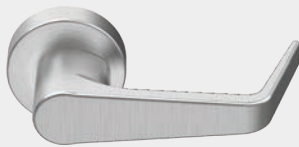

Latitude (LAT)



Longitude (LON)

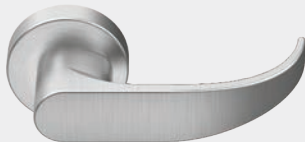

Quantum (Q)

Standard rose  
Dane lever  
shownSmall rose  
Dane lever  
shown

### Lever dimensions chart

Lever	A - width	B - projection	C - rose	
			Standard	Small (SR)
Avalon (A)	4 1/2"	2 1/2"	3 3/8"	2 9/16"
Boardwalk (BRK)	5"	2 1/2"	3 3/8"	2 9/16"
Broadway (BRW)	4 1/2"	2 1/2"	3 3/8"	2 9/16"
Dane (D)	4 5/8"	2 1/2"	3 3/8"	2 9/16"
Latitude (LAT)	4 1/2"	2 3/8"	3 3/8"	2 9/16"
Longitude (LON)	5"	2 3/8"	3 3/8"	2 9/16"
Quantum (Q)	4 5/8"	2 3/8"	3 3/8"	2 9/16"

Note: Return to door meets 1/2" requirement for Dane (D), Quantum (Q), Boardwalk (BRK) and Longitude (LON) levers.

Specify lever only if standard rose is desired. When ordering small rose you must specify both rose and lever. Example: Small rose-Avalon specify as SRA; Small rose-Latitude specify as SRLA; Small rose-Quantum specify as SRQ.

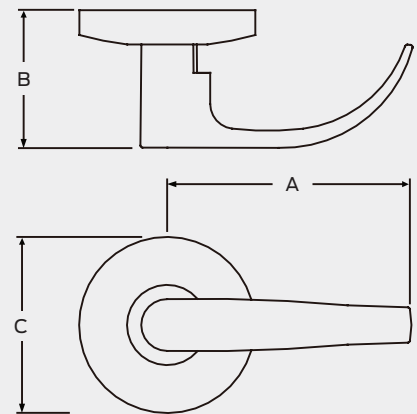

### Abrasive strip levers

Dane, and Quantum levers are available with an abrasive strip along the inside length of the lever to identify entrances that may be to areas hazardous to the handicapped. To order, preface the design code with a 6 (example: 6D for Dane). Not available on 613 finish as abrasive strip will not hold.



Designs and styles

# Knob styles

Knobs are constructed of brass or cold-formed steel and are zinc-plated and dichromated for rust resistance. Springs are stainless steel. Roses are heavy-wrought brass or bronze, installed over wrought steel reinforcing plates. Knobs are brass or bronze, secured by a steel knob retainer, which cannot be depressed when lock has been locked.

Cointurn  
Elite shown



Cylinder  
Elite shown



Interchangeable core  
Elite shown



Plain  
Hana shown



Pushbutton (interior)  
Hana shown



Thumbturn (interior)  
Hana shown



Elite

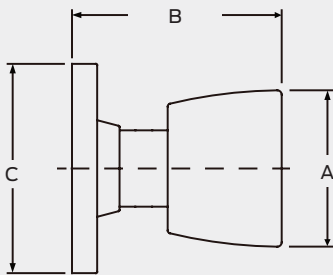

Hana

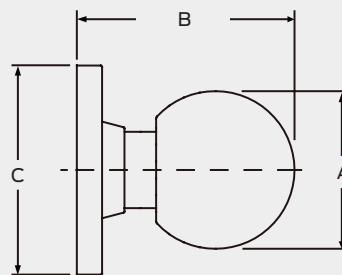

**Knob dimensions chart**

Knob	A - width	B - projection	C - rose
			Standard
Elite (E)	2 1/8"	2 15/32"	3 3/8"
Hana (H)	2 3/16"	2 9/16"	3 3/8"

**Finishes**

Levers: Available in BHMA 605, 606, 613, 619, 622, 625, 626 and 643e.

Knobs: Available in BHMA 605, 606, 613, 625, and 626. See page 6 for finish color and comparative chart.

## Cylinders

## W Series cylinders

**Falcon Small Format Interchangeable Core (SFIC) cylinders**

Falcon offers a wide selection of keyways in SFIC cylinder formats. Master keying is available and, in most cases, Falcon can even furnish cores master keyed into existing Best or Arrow key systems. See page 8 for details.

**Conventional cylinders (Falcon keyways)**

Catalog number	Description
Q330-154	Falcon (specify keyway)

Note: The "G" keyway is standard and will be supplied unless otherwise specified. Master keying is available for 2, 3, and 4 levels. Open keyways include E, H, K, L, and P. If ordering cylinders as parts, specify finish: 606, 622 or 626.



Conventional cylinder

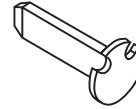

**Q330-164**  
Conventional cylinder tailpiece (all other functions)

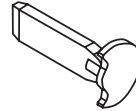

**Q330-165**  
Conventional cylinder tailpiece (W561 function)

**To order conventional cylinders in competitive keyways (6-pin)**

When specifying a competitive cylinder, reference How-to-order page for correct cylinder suffix and be sure to list brand plus keyway under the "Keyway" section and the correct part number below in the "Other Requirements" area of the part number order string.

Brand	Keyway	O-Bit	KA	KD	Lock function
Corbin	60	Q330-166	-	Q330-166-KD	All except 561
		Q330-167	-	Q330-167-KD	561
Corbin Russwin	L4	Q330-158	-	Q330-158-KD	All except 561
		Q330-159	-	Q330-159-KD	561
Russwin	D1	Q330-210	-	Q330-210-KD	All except 561
		Q330-211	-	Q330-211-KD	561
Sargent	LA	Q330-160	-	Q330-160-KD	All except 561
		Q330-161	-	Q330-161-KD	561
Schlage	C	Q330-152	Q330-152-KA	Q330-152-KD	All except 561
		Q330-153	Q330-153-KA	Q330-153-KD	561
Yale	8 (Para)	Q330-156	-	Q330-156-KD	All functions

Note: Construction keying available. Reference page 9 for more information.

Options

# Latches

## Grade 1, UL listed

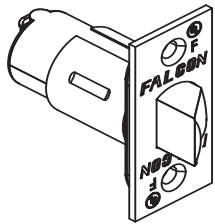

1/2" projection

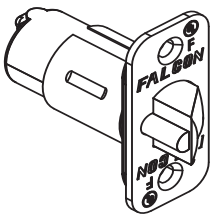

1/2" projection

	Specify	Backset	Function(s)	Description
Springlatch	30-206 <sup>1</sup>	2 3/4"	101, 301	Square corner, 1 1/8" x 2 1/4", standard
	30-204	2 3/4"	101, 301	Square corner, 1" x 2 1/4"
	30-205	2 3/4"	101, 301	Radius corner, 1" x 2 1/4"
	30-209 <sup>1</sup>	2 3/8"	101, 301	Square corner, 1 1/8" x 2 1/4"
	30-207	2 3/8"	101, 301	Square corner, 1" x 2 1/4"
	30-208	2 3/8"	101, 301	Radius corner, 1" x 2 1/4"
Deadlatch	30-194	2 3/4"	201, 511, 571, 711	Square corner, 1 1/8" x 2 1/4"
	30-192	2 3/4"	201, 511, 571, 711	Square corner, 1" x 2 1/4"
	30-193	2 3/4"	201, 511, 571, 711	Radius corner, 1" x 2 1/4"
	30-200 <sup>1</sup>	2 3/8"	201, 511, 571, 711	Square corner, 1 1/8" x 2 1/4"
	30-198	2 3/8"	201, 511, 571, 711	Square corner, 1" x 2 1/4"
	30-199	2 3/8"	201, 511, 571, 711	Radius corner, 1" x 2 1/4"
	30-197 <sup>1</sup>	2 3/4"	161, 501, 511, 561, 581	Square corner, 1 1/8" x 2 1/4", non-restoring, standard
	30-195	2 3/4"	161, 501, 511, 561, 581	Square corner, 1" x 2 1/4, non-restoring
	30-196	2 3/4"	161, 501, 511, 561, 581	Radius corner, 1" x 2 1/4, non-restoring
	30-203 <sup>1</sup>	2 3/8"	161, 501, 511, 561, 581	Square corner, 1 1/8" x 2 1/4", non-restoring
30-201	2 3/8"	161, 501, 511, 561, 581	Square corner, 1" x 2 1/4, non-restoring	
30-202	2 3/8"	161, 501, 511, 561, 581	Radius corner, 1" x 2 1/4, non-restoring	

1. Available with small rose.

Note: Specify finish 605, 606, 613, 619, 622, 625, 626, or 643e. All latches for W Series locks are UL listed and have a 1/2" bolt projection.

# Strikes

Locks furnished with a 4 7/8" ANSI Strike unless otherwise specified.

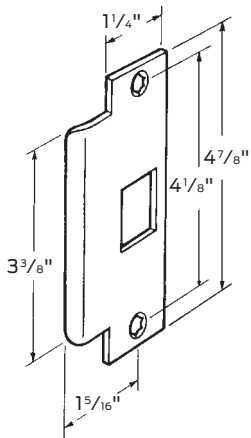

**30-148**  
ANSI prep A115.2  
(standard)

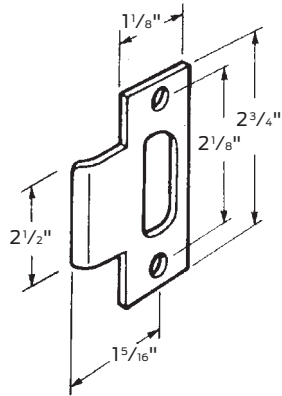

**30-149**  
T-strike square corner

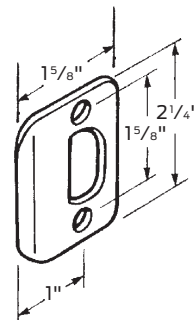

**30-150**  
Full lip, 1/4" radius corner

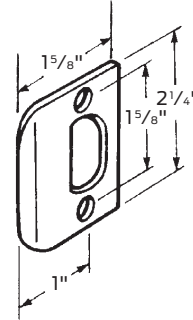

**30-151**  
Full lip, square corner

# RU Series

Extra heavy-duty preassembled unit locks

When you need to replace an existing notched-style lock and get up to code on ADA accessibility, the Falcon RU Series is a perfect fit. Designed specifically for retrofitting older and historical buildings, this unique lock combines old-fashioned styling with modern strength, security and convenience. It can retrofit existing unit locks manufactured by Falcon, Corbin Russwin and Yale, and installs with minimal rework to existing doors.

## Features

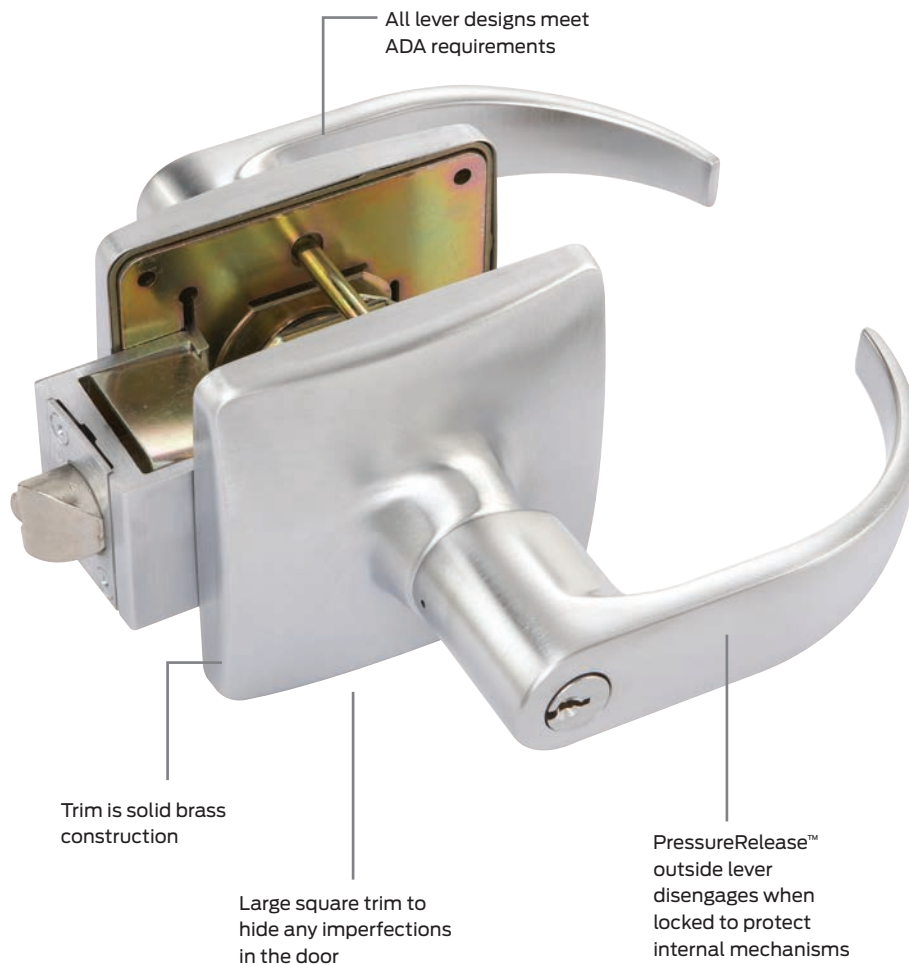

RU Series lock is also available electrified for use in a wired access control system or as an independently controlled lock with a remote access switch.

## Specifications

# RU Series

### Features

- Vandal resistant PressureRelease™ outside lever disengages when locked to prevent damage to internal mechanism
- 2 lever designs
- Complements Falcon's "family" of lever designs
- "Power Spring™" in rose trim prevents lever sag
- 12 commercial lock functions
- 2 standard finishes: 613 and 626
- No exposed mounting screws
- Solid bar stock deadlocking feature prevents latch binding and lock failure due to poor door alignment
- Meets or exceeds all ANSI A156.2 rigorous Grade 1 specifications for key-in-lever products

### Benefits

- Preserves existing facility doors and frames
- Preserves original architectural design without adapter plate or add-ons
- Easy installation with minimal door modifications
- Features a 4" square rose which covers existing mounting holes, most paint lines and required door rework
- Complies with ADA easy access requirements
- Strikes available to match existing frame preparation
- Reuse existing facility cylinders and key system
- Non-handed chassis and field reversible trim and latch bolt for easy stocking and lower inventory cost
- Key removable outside lever for easy cylinder replacement
- Outside lever secured by a spring-loaded retainer. Retainer cannot be depressed when locks have been locked. Inside lever secured by a set screw. Levers have heavy-duty steel individual return springs in order to prevent lever sag

### Product specifications

**ANSI/BHMA:** ANSI/BHMA: Certified ANSI/BHMA A156.2, Series 4000, Grade 1.

**UL:** Listed for 3-hour fire door, A label.

**Functions:** 10 mechanical and 2 electrified (24 VDC .185 Amp) commercial functions available. See page 10 for details.

**Finishes:** 2 options available. See page 6 for finish color and comparative chart.

**Door thickness:** 1<sup>3</sup>/<sub>4</sub>" to 2<sup>1</sup>/<sub>8</sub>" standard.

**Backset:** 2<sup>3</sup>/<sub>4</sub>" only.

**Attachment:** Installs with 10-32 through-bolt screws with thread sealant for extra security and resistance to vibrating loose. Interchangeable core levers are not removable with core installed.

**Handing:** Locks are non-handed.

**Cylinder:** Conventional cylinder, drilled with 6-pin chambers, pinned in 5 comes standard. Pinning in 6 chambers available (at no cost) when specified. Optional 7-pin conventional and 6- or 7-pin Small Format Interchangeable Core (SFIC) cylinders. Cylinder housings and plugs machined from solid brass. Springs are phosphor bronze. Two nickel silver keys furnished standard. See SFIC cylinder information on page 8 and RU Series cylinder pages for additional options.

**Keyways:** "G" keyway standard in conventional cylinders. "A" keyway standard in SFIC cylinders. Additional options: Falcon, Schlage and many Best and Arrow keyways.

**Strike:** 4 <sup>7</sup>/<sub>8</sub>" x 1 <sup>1</sup>/<sub>4</sub>" ANSI strike with curved lip to meet ANSI A115.2 door frame preparation standard.

## Designs and styles

# Lever styles

Levers are solid pressure cast zinc, finished to match mating parts. Roses are wrought brass or bronze, and are installed over pressure cast through-bolted rose inserts. Levers are secured by a spring-loaded retainer. Retainer cannot be depressed when locks have been locked.

Dane (D)



Quantum (Q)

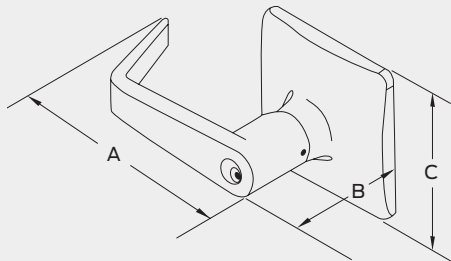

### Lever dimensions chart

Lever	A - width	B - projection	C - rose
Dane (D)	5"	3 1/4"	4"
Quantum (Q)	5"	3 1/4"	4"

Note: Return to door meets 1/2" requirement for Dane (D) and Quantum (Q) levers.

### Abrasive strip levers

Levers are available with an abrasive strip along the inside length of the lever to identify entrances that may be to areas hazardous to the handicapped. To order, preface the design code with a 6 (example: 6D for Dane). Not available on 613 finish as abrasive strip will not hold.

### Finishes

Available in BHMA 613 (Dane lever style only) and 626. See page 6 for finish color and comparative chart.

## Cylinders

# RU Series cylinders

### Falcon Small Format Interchangeable Core (SFIC) cylinders

Falcon offers a wide selection of keyways in SFIC cylinder formats. Master keying is available and, in most cases, Falcon can even furnish cores master keyed into existing Best or Arrow key systems. See page 8 for details.

### To order conventional cylinders in competitive keyways (6-pin)

When specifying a competitive cylinder, reference How-to-order page for correct cylinder suffix and be sure to list brand plus keyway under the "Keyway" section and the correct part number below in the "Other Requirements" area of the part number order string.

Brand	Keyway	O-Bit	KA	KD	Lock function
Arrow		A23170-000	A23170-0KA	A23170-0KD	All except 571 and 381(I/S)
		A23170-011	A23170-11A	A23170-11D	381(I/S)
		A23170-012	A23170-12A	A23170-12D	571
Corbin	60	A23167-000	-	A23167-0KD	All except 571 and 381(I/S)
		A23167-011	-	A23167-11D	381(I/S)
		A23167-012	-	A23167-12D	571
Corbin Russwin	L4	A23174-000	-	-	All except 571 and 381(I/S)
		A23174-011	-	-	381(I/S)
		A23174-012	-	-	571
Russwin	D1	A23168-000	-	A23168-0KD	All except 571 and 381(I/S)
		A23168-011	-	A23168-11D	381(I/S)
		A23168-012	-	A23168-12D	571
Sargent	LA	A23166-000	-	A23166-0KD	All except 571 and 381(I/S)
		A23166-011	-	A23166-11D	381(I/S)
		A23166-012	-	A23166-12D	571
Schlage	C	A23160-000	A23160-0KA	A23160-0KD	All except 571 and 381(I/S)
		A23160-011	A23160-11A	A23160-11D	381(I/S)
		A23160-012	A23160-12A	A23160-12D	571
	E	A23159-000	-	-	All except 571 and 381(I/S)
		A23159-011	-	-	381(I/S)
		A23159-012	-	-	571
Yale	8 (Para)	A23169-000	-	A23169-0KD	All except 571 and 381(I/S)
		A23169-011	-	A23169-11D	381(I/S)
		A23169-012	-	A23169-12D	571
	GA	A23158-000	-	-	All except 571 and 381(I/S)
		A23158-011	-	-	381(I/S)
		A23158-012	-	-	571

### Reference chart for locks ordered less cylinder

Falcon offers many "less cylinder" options for when you need a quality lock to fit into an existing key system. For levers prepared to fit competitive key systems, please reference the list below. A proper tailpiece is supplied with the lock unless otherwise noted.

Conventional cylinders	Full Size IC	Unit/Mono locks
Assa 65611 and 65661, 6-pin <sup>1</sup>	Assa 70600IC and V70600IC, 6-pin	Corbin Russwin, 2000-052 (master ring not available)
Corbin Russwin 2000-034 and CL3400, 6-pin (master ring not available) <sup>1</sup>	Corbin Russwin 8000, 6-pin and 8000-7, 7-pin	Falcon conventional, 6-pin (R Series old small plug)
Medeco 20W200V3, 6-pin (Falcon/Schlage style) <sup>1</sup>	Medeco 31 Series, 6-pin and 32 Series, 7-pin	Medeco 20W5005 retrofit cylinder for Corbin Russwin unit lock
Peaks (Kaba), 6-pin <sup>1</sup>	Peaks (Kaba), 6- and 7-pin	Medeco 20W0500 retrofit cylinder for Yale 6200 unit lock
Sargent 6, 7, and 10 Line, 6-pin (Keso not available)	Sargent 6300, 6-pin	Yale 1801 mono lock and later models
Schlage Classic and Primus, 6-pin <sup>1</sup>	Schlage Classic and Primus, 6-pin	
Yale 1810, 6-pin (Bicentric not available)	Yale 1210, 6-pin	

1. Tailpiece not supplied.

## Options

## Latches

Options for configured locks.

**Grade 1, UL listed is standard for all 1/2" projection latches and optional for 3/4"**

	Specify	Backset	Latch height	Door thickness
Springlatch or deadlatch 1/2" projection	314691	2 3/4"	1 3/4"	1 3/4", standard
	314692	2 3/4"	2 1/16"	1 3/4"
	314693	2 3/4"	2 5/8"	1 3/4"
	314694	2 3/4"	2 11/16"	1 3/4"
Deadlatch 3/4" projection	315691	2 3/4"	1 3/4"	1 3/4"
	315692	2 3/4"	2 1/16"	1 3/4"
	315693	2 3/4"	2 5/8"	1 3/4"
	315694	2 3/4"	2 11/16"	1 3/4"
Springlatch 1/2" projection	316231	2 3/4"	1 3/4"	2", standard
	316232	2 3/4"	2 1/16"	2"
	316233	2 3/4"	2 5/8"	2"
	316234	2 3/4"	2 11/16"	2"
	316241	2 3/4"	1 3/4"	2 1/4", standard
	316242	2 3/4"	2 1/16"	2 1/4"
	316243	2 3/4"	2 5/8"	2 1/4"
	316244	2 3/4"	2 11/16"	2 1/4"

Note: Specify finish 613 or 626 and door thickness. Also note latch height in the "Other requirements" area of the part number order string.

## 1/2" projection, standard, UL listed

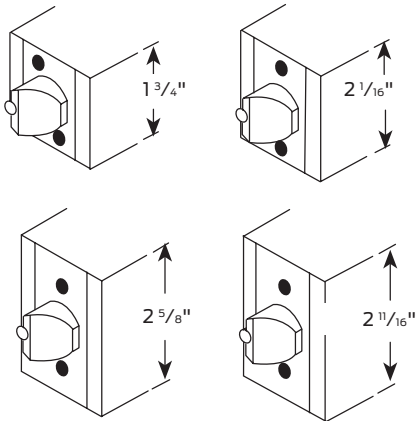

## 3/4" projection, optional, UL listed

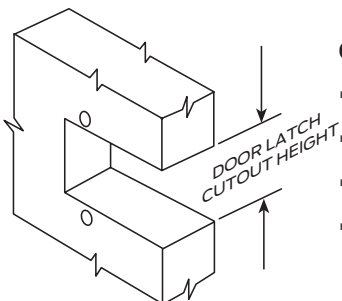
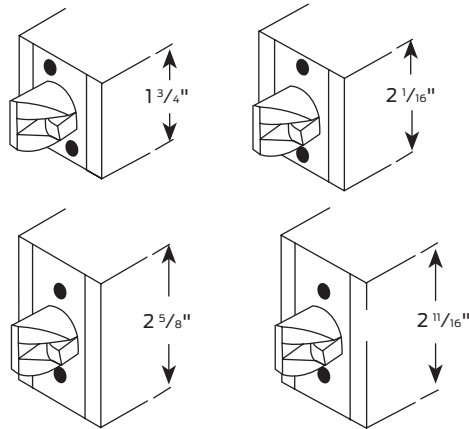

## Competitive lock cutout heights

- 1 3/4" most Corbin & Russwin sold 1949 through current; Yale 6300
- 2 1/16" Corbin, Falcon
- 2 5/8" Corbin (O)2400 Series sold 1913-1953
- 2 11/16" Russwin 2100 and 2800 Series sold 1904-1968



Options and accessories

# Strikes

Locks furnished with a 1 1/4" x 4 7/8" ANSI strike unless otherwise specified.  
 Optional dustboxes: 1" deep ANSI steel dust box specify 005099-000-30.  
 3/4" deep dust box for 3 1/4" high strike specify 031453-000-30.

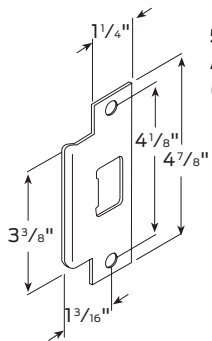

**5164\***  
ANSI Prep A115.2  
(standard)

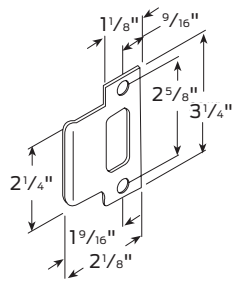

**31471\***  
Early Corbin Russwin  
single door

Note: Strike, door and lock same center line

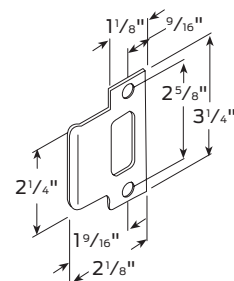

**31471S\***  
Early Corbin Russwin  
single door

Note: Strike center line is not the same as door and lock

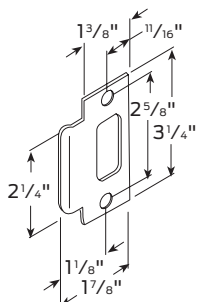

**31472\***  
Early Corbin  
Russwin pair  
of doors

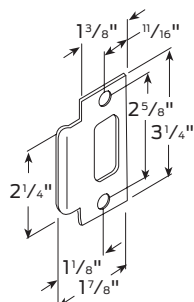

**31473\***  
Yale mono pair  
of doors

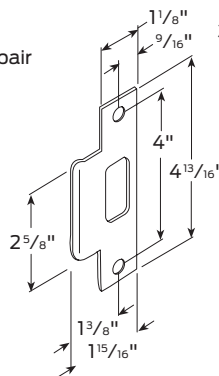

**31474\***  
Early Corbin

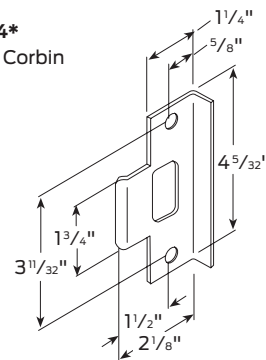

**31477\***  
Early Russwin  
unit lock

\* Specify finish: 613, 626 or 630.

# MA Series

Grade 1 mortise lever  
and knob locks

The Falcon MA Series delivers the heavy-duty performance of a Grade 1 mortise lock at an affordable price for your office, hospital, education, or other commercial project. MA, as one of Falcon's toughest and most dependable locks, is designed to handle high-traffic, high-abuse applications. And, with generous trim and finish styles, the MA Series makes it easy to match existing or new design choices. Cylinders offered include the Small Format Interchangeable Core cylinders that can be removed quickly for easy, fast re-keying in high turnover environments.

## Features

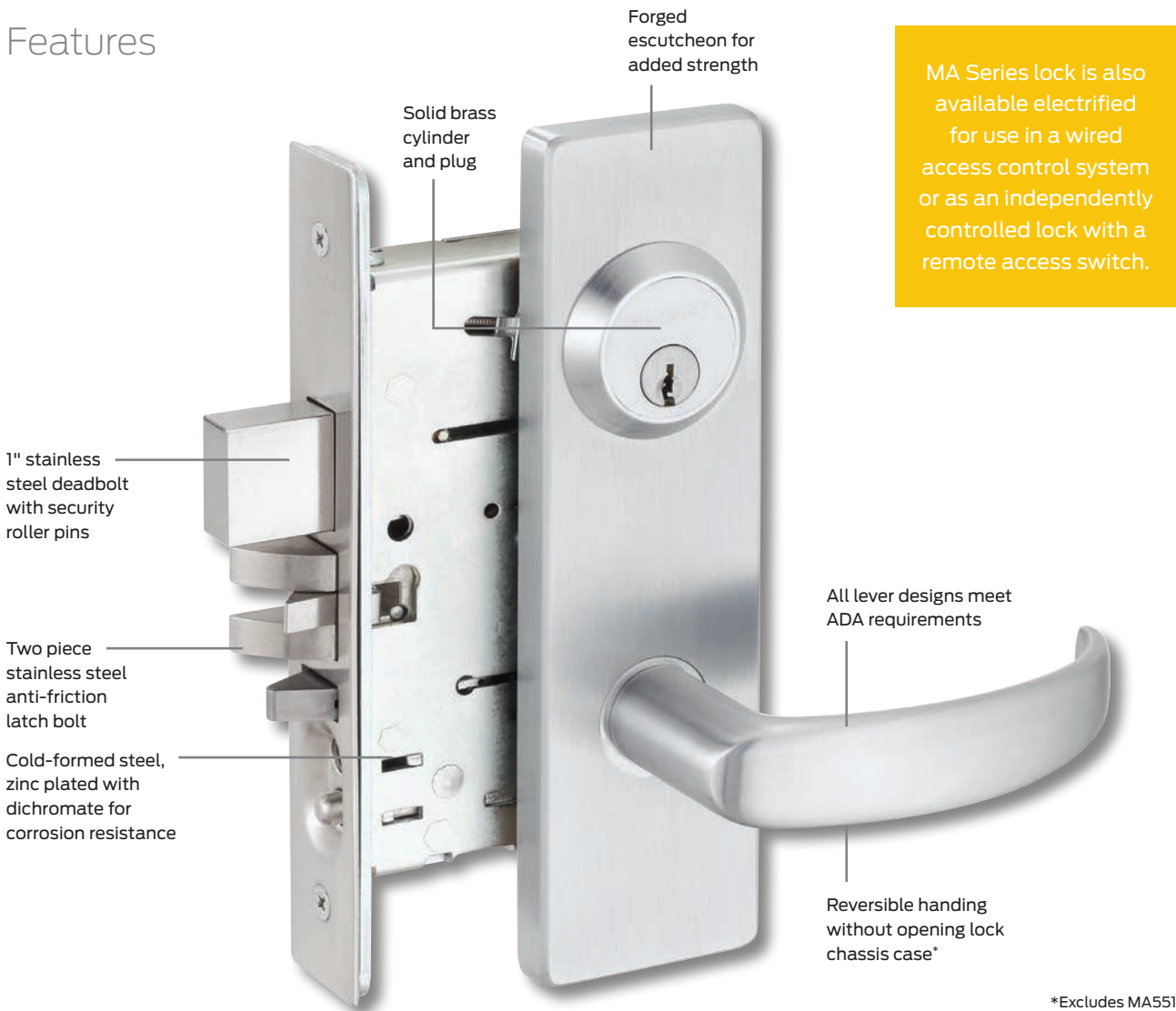

\*Excludes MA551

## Specifications

# MA Series

### Product specifications

**ANSI/BHMA:** Certified ANSI/BHMA 156.13, Series 1000, Grade 1.

**UL:** Listed 3-hour fire door, A label.

**Functions:** 26 mechanical and 2 electrified (12 or 24 VDC) commercial functions available. See page 46 for details.

**Finishes:** 9 options available. See page 6 for finish color and comparative chart.

**Door thickness:** Standard offering only accepts door thicknesses of 1<sup>3</sup>/<sub>4</sub>" - 1<sup>7</sup>/<sub>8</sub>". If door thickness is between 1<sup>7</sup>/<sub>8</sub>" and 2<sup>1</sup>/<sub>2</sub>" customer must specify thickness.

**Backset:** 2<sup>3</sup>/<sub>4</sub>" only.

**Case:** Cold formed steel, zinc dichromate plated, .090" thick. Optional lead wrapping available.

**Hubs:** Hardened steel.

**Handing:** Right hand is standard; left hand optional. Reversible in the field.

**Cylinders:** Conventional cylinder, drilled with 6-pin chambers, pinned in 5 comes standard. Pinning in 6 chambers available (at no cost) when specified. Optional 7-pin conventional and 6- or 7-pin Small Format Interchangeable Core (SFIC) cylinders. Mortise and cylinder housings and plugs machined from solid brass. Springs are phosphor bronze. Two nickel silver keys furnished standard. Hotel function cylinders available. For details, see price book. SFIC cylinder information on page 8.

**Keyways:** "G" keyway standard on conventional cylinders. "A" keyway standard on SFIC cylinders. Additional options: Falcon, Schlage and many Best and Arrow keyways.

**Bind resistant trim:** Heavy-duty through-bolted inserts clamp the trim on the door assuring proper alignment. Provided with 8-32 screws for strength and thread sealant to prevent loosening.

**Latch bolt:** Two-piece stainless steel, mechanical anti-friction bolt. <sup>3</sup>/<sub>4</sub>" projection.

**Dead bolt:** 1" throw, stainless steel with two <sup>3</sup>/<sub>16</sub>" diameter hardened steel, free-turning, saw-resistant roller.

**Faceplates:** (armored front) 1<sup>1</sup>/<sub>4</sub>" x 8" brass or stainless steel adjustable for door bevel. Reinforced by heavy gauge steel with stabilizing ribs.

**Strike:** Brass or stainless steel. Meets ANSI A115.1 for frame preparation. Strike is non-handed.

**Indicator options:** Occupied/Vacant or Locked/Unlocked.

### Architectural specifications

- Provide mortise locksets that comply with ANSI A156.13, Series 1000, Operational Grade 1 and Security Grade 1 with all standard trims and conventional mortise cylinders.
- Locksets comply with UL10B - neutral pressure and UL10C/UBC 7-2 –positive pressure testing requirements. All locks shall be UL listed for 3 hour fire door.
- Lock case shall be non-handed, reversible without opening the lock case, and shall be manufactured of zinc dichromate plated steel. Lock case shall be interchangeable for knob or lever applications without modifying the chassis, and shall be constructed with a screw configuration that limits access to operating parts.
- Latchbolt shall be 2-piece anti-friction type manufactured from stainless steel, with a standard 2<sup>3</sup>/<sub>4</sub>" backset, a full <sup>3</sup>/<sub>4</sub>" throw and be field reversible. Deadbolt shall have 1" throw and shall be constructed of stainless steel, incorporating two <sup>3</sup>/<sub>16</sub>" diameter security roller pins. All lever designs shall meet the federal ADA and state disability requirements.
- All trim shall be cast, forged, or wrought and through bolted with thread patch coated screws. Lever trim to have individual heavy duty springs for lever return, and independent rotation in both directions. Return to door style levers meets the <sup>1</sup>/<sub>2</sub>" California State Fire Marshall requirement.
- Spindles to be independent, designed to 'break-away' at a maximum of 480 in./lbs. to prevent damage to the lock chassis.
- Provide standard non-handed curved lip strikes.
- Cylinders to be secured by a dual retainer.
- Acceptable manufacturer: Falcon Lock

## Designs and styles

# Lever/knob styles

Cast or forged levers (Avalon, Dane, Quantum, Boardwalk, Broadway, Latitude and Longitude) and wrought brass or stainless levers/knobs (Sutro and Hana), wrought rose and forged or wrought escutcheons are standard. Specify lever/knob style and rose/escutcheon style when ordering.

Avalon (AG/AN)

Boardwalk<sup>1</sup> (BOG/BON)Broadway<sup>1</sup> (BRG/BRN)

Dane (DG/DN)

Latitude<sup>1</sup> (LTG/LTN)Longitude<sup>1</sup> (LGG/LGN)

Quantum (QG/QN)

Sutro<sup>2</sup> (SG/SN)

Hana (HG/HN)



1. 630 finish not available with these lever designs.
2. Sutro lever not available in 619, 622 or 643e finishes.

### Abrasive strip levers

Avalon, Dane, Quantum, and Sutro levers are available with an abrasive strip along the inside length of the lever to identify entrances that may be to areas hazardous to the handicapped. To order, preface the design code with a 6 (example: 6DG for Dane Gala). Not available on 613 finish as abrasive strip will not hold. Knurling option is also available for these same levers using an 8 prefix.

### Finishes

**Levers:** available in BHMA 605, 606, 613, 619, 622, 625, 626, 630, and 643e.

**Knobs:** available in BHMA 619, 622, and 643e. See page 6 for finish color and comparative chart.

**Mortise and rim cylinder housings:** available in 605, 606, 613, 619, 622, 626, 629, 630, and 643e.

Designs and styles

# Trim styles

Gala rose (G)

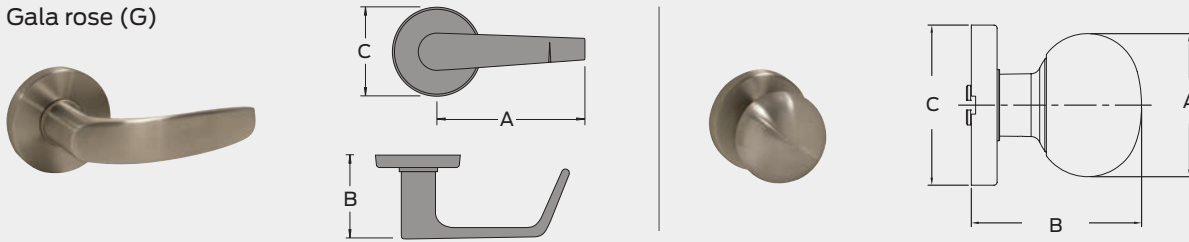

Napa escutcheon (N)

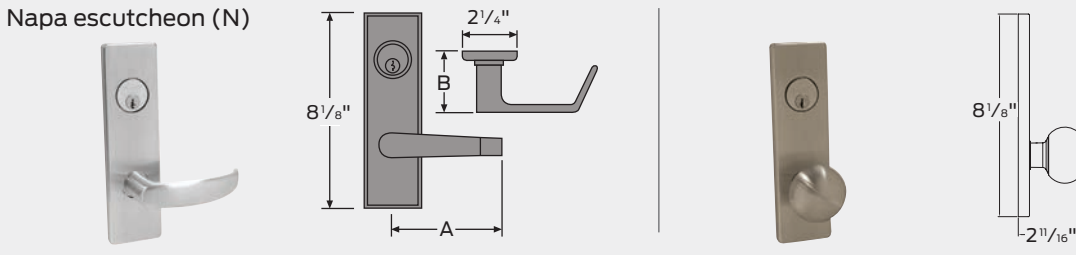

### Lever dimensions chart

Lever	A - width	B - projection	C - rose		Escutcheon
			Gala (G)	Napa (N)	
Avalon (A)	4 1/2"	2 5/8"	2 9/16"		8 1/8"H x 2 1/4"W
Boardwalk (BO)	5 1/16"	2 3/4"	2 9/16"		
Broadway (BR)	5 1/16"	2 3/4"	2 9/16"		
Dane (D)	4 9/16"	2 1/2"	2 9/16"		
Latitude (LT)	4 13/16"	2 11/16"	2 9/16"		
Longitude (LG)	4 13/16"	2 11/16"	2 9/16"		
Quantum (Q)	4 5/8"	2 11/16"	2 9/16"		
Sutro (S)	4 7/8"	2 7/8"	2 9/16"		

Note: Return to door meets 1/2" requirement for Dane, Quantum, Boardwalk and Longitude and Sutro levers.  
Specify both lever and rose or escutcheon when ordering. Example: Avalon-Gala specify as AG; Latitude-Napa specify as LTN; Sutro-Gala specify as SG.

### Knob dimensions chart

Knob	A - width	B - projection	C - rose		Escutcheon
			Gala (G)	Napa (N)	
Hana (H)	2 1/4"	2 11/16"	2 9/16"		8 1/8"H x 2 1/4"W









Note: Specify both knob and rose or escutcheon when ordering.  
Example: Hana-Gala specify as HG; Hana-Napa specify as HN.

## Functions

To order Falcon MA Series locksets, please consult page 7 for ordering information and assistance.

 Indicates interchangeable core available.

 Indicates indicator trim available.

Catalog number	ANSI	Function outside/inside	Name	Description
MA101	F 01		Passage/closet latchset	Latch bolt operated by knob/lever from either side at all times. Inside knob/lever always free for immediate egress.
MA161	F 31		Connecting room/exit lock	Latch bolt operated by knob/lever from inside. No trim outside. Auxiliary dead latch.
MA301	F 02		Privacy lock	Latch bolt operated by knob/lever from either side. Dead bolt operated by turn from inside and by emergency release from outside.
MA311	F 19		Privacy, bedroom or bath lock with inside lever release	Latch bolt operated by knob/lever from either side. Dead bolt operated by turn from inside and emergency release from outside. Operating inside knob/lever retracts both bolts. Inside knob/lever always free for immediate egress.
MA321	F 22		Privacy lock with no entry lockout	Latch bolt operated by knob/lever from either side except when outside knob/lever is locked by inside turn. Operating inside knob/lever, closing door or operating outside emergency release unlocks outside knob/lever. Inside knob/lever always free for immediate egress.
MA371*	F 14		Store door lock	Latch bolt operated by knob/lever from either side. Dead bolt operated by key from either side.
MA381	F 09		Apartment exit lock	Latch bolt operated by knob/lever from either side, except when outside knob/lever is locked by key from inside. When outside knob/lever is locked, latch bolt is retracted by key from outside or by operating inside lever. Auxiliary dead latch. Inside knob/lever always free for immediate egress.
MA411*	F 30		Asylum lock	Latch bolt operated by key from either side. Both knobs/levers always inoperative. Auxiliary dead latch.
MA431	F 34		Security lock with deadbolt	Latch bolt operated by knob/lever from either side except when outside knob/lever is locked from inside or outside by key. Dead bolt retracted by key from inside or outside. Operating inside knob/lever retracts both bolts and unlocks outside. Latch bolt dead locked when dead bolt is thrown. Inside knob/lever always free for immediate egress.









\*Caution: Double cylinder locks on residences and any door, in any structure, which is used for egress are a life safety hazard in times of emergency and their use is not recommended. Installation should be in accordance with existing codes only.

## Functions

To order Falcon MA Series locksets, please consult page 7 for ordering information and assistance.

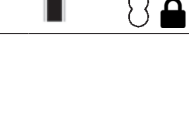
 Indicates interchangeable core available.

 Indicates indicator trim available.

Catalog number	ANSI	Function outside/inside	Name	Description
MA441	F 32		Classroom security lock	Latch bolt operated by knob/lever from either side except when outside knob/lever is locked from inside or outside by key. When outside knob/lever is locked, latch bolt is retracted by key from inside or outside or by operating inside knob/lever. Auxiliary dead latch. Inside knob/lever always free for immediate egress.
MA451	F 15		Hotel guest lock	Latch bolt operated by key from outside or by operating inside knob/lever. Outside knob/lever is always inoperative. Dead bolt projected by turn from inside and all keys except emergency key are shut out. Operating inside knob/lever retracts both bolts. Auxiliary dead latch. Inside knob/lever always free for immediate egress.
MA521	F 04		Entry/office lock with button lockout	Latch bolt operated by knob/lever from either side except when outside knob/lever is made inoperative by buttons in face. When outside knob/lever is locked, latch bolt is retracted by key from outside or by operating inside knob/lever. Auxiliary dead latch. Outside knob/lever is unlocked by button on face. Inside knob/lever always free for immediate egress.
MA531	F 12/ F 20		Apartment corridor lock	Latch bolt operated by knob/lever from either side, except when outside knob/lever is made inoperative by buttons in face. Dead bolt operated by key outside or turn inside. Key outside operates both bolts. Operating inside knob/lever retracts both bolts and outside remains locked. Latch bolt is deadlocked when outside knob/lever is made inoperative or when the dead bolt is projected. When dead bolt is retracted, knob/lever is unlocked by buttons in face. Inside knob/lever always free for immediate egress.
MA541*	F 21		Entry or office lock	Latch bolt operated by knob/lever from either side. Dead bolt operated by key from outside or turn from inside.
MA551	F 06		Holdback lock	Latch bolt operated by lever from either side except when outside lever is locked from outside by key. Latch bolt can be locked in a retracted position by key. When outside lever is locked, latch bolt is retracted by key from outside or by operating inside lever unless latch bolt has been locked in a retracted position. Auxiliary dead latch. To activate the Holdback Function – from the unlocked position rotate the outside lever/knob to retract the latchbolt. Rotate key 360°. Release lever/knob. To release Holdback Function, rotate key 360° clockwise. Inside knob/lever always free for immediate egress.  Note: Chassis is handed.
MA561	F 05		Classroom lock	Latch bolt operated by knob/lever from either side except when outside knob/lever is locked from outside by key. When outside knob/lever is locked, latch bolt is retracted by key from outside, or by operating inside knob/lever. Auxiliary dead latch deadlocks latchbolt when door is closed. Inside knob/lever always free for immediate exit.
MA571	F 13		Dormitory or exit lock	Latch bolt operated by knob/lever from either side. Dead bolt projected by key from outside and turn from inside. Operating inside knob/lever retracts both bolts and unlocks outside. Inside knob/lever always free for immediate egress.
MA581	F 07		Storeroom lock	Latch bolt operated by key from outside or by operating inside knob/lever. Outside knob/lever is always inoperative. Auxiliary dead latch. Inside knob/lever always free for immediate egress.







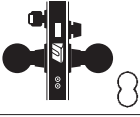

\*Caution: Double cylinder locks on residences and any door, in any structure, which is used for egress are a life safety hazard in times of emergency and their use is not recommended. Installation should be in accordance with existing codes only.

## Functions

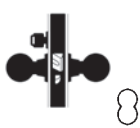
To order Falcon MA Series locksets, please consult page 7 for ordering information and assistance.

 Indicates interchangeable core available.

 Indicates indicator trim available.

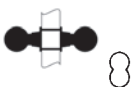
Catalog number	ANSI	Function outside/inside	Name	Description
MA621	F 08/ F 10		Apartment corridor lock with button lockout	Latch bolt is operated by knob/lever from either side, except when outside knob/lever is made inoperative by buttons in face. Dead bolt is operated by turn inside. Key outside operates both bolts. Outside knob/lever is unlocked by button on face. Inside knob/lever always free for immediate egress.
MA641	NA		Dormitory lock	Latch bolt by knob/lever inside and key outside. Inside knob/lever free. Outside knob/lever rigid. Deadbolt by key outside or T-turn inside. Rotating inside knob/lever retracts both bolts. Deadlocking latch. Inside knob/lever always free for immediate egress.
MA851	NA		Storeroom-fail safe (EL - 12 or 24V DC) (RX option - request to exit)	Latch bolt operated by knob/lever from either side except when outer knob/lever is electrically locked. When outer knob/lever is locked, latch bolt retracted by key in cylinder outside. Deadlocking latch. Inside knob/lever always free for immediate egress.  Note: Specify 12V or 24V DC.
MA881	NA		Storeroom-fail secure (EU - 12 or 24V DC) (RX option- request to exit)	Latch bolt operated by knob/lever from inside except when outer knob/lever is electrically unlocked, then latch bolt from either side. When locked, key in cylinder outside retracts latch bolt. Deadlocking latch. Inside knob/lever always free for immediate egress.  Note: Specify 12V or 24V DC.
MA911	F 29		Classroom dead lock	Key from outside operates dead bolt. Turn from inside retracts but does not project dead bolt.
MA921	F 18		Outside only deadlock	Dead bolt operated by key from outside only.
MA931*	F 16		Two sided deadlock	Dead bolt operated by key from either side.
MA941	F 17		Deadlock with inside turn	Dead bolt operated by key from outside and by turn from inside.
MA12	NA		Single dummy	Single dummy trim
MA18	NA		Double dummy	Double dummy trim

\*Caution: Double cylinder locks on residences and any door, in any structure, which is used for egress are a life safety hazard in times of emergency and their use is not recommended. Installation should be in accordance with existing codes only.



Options and accessories

# Trim packages

Both knob and lever trim packages are available to allow complete replacement of inner and outer trim on any lock function. Packages include inside and outside trim, spindle and mounting screws. Please see current price book for more details.

### Trim options



#### Abrasive coated knobs and levers<sup>1</sup>

Knobs and levers are available with abrasive coating to identify entrances to hazardous areas to the handicapped.

#### Knurled levers<sup>1</sup>

Levers are available knurled to identify entrances to hazardous areas to the handicapped.

#### Lead wrapping<sup>1</sup>

MA Series locksets and latchsets are available with lead-wrapping for use on X-ray room doors (or similar situations).

### Strikes

Manufactured from heavy gauge brass or stainless steel. Meets ANSI Standard A115.1 for frame preparation. Strikes are available with various lip lengths.



### Thumb turn/threaded cylinders (sold separately)

Standard thumb turn threaded cylinders for deadbolt operation of MA Series locks may be used in lieu of surface mounted thumb turns. Furnished with A09894-1 cam. Available in length indicated and all MA Series finishes.

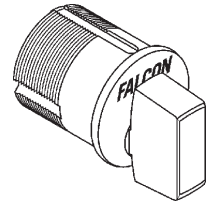

Catalog number	Length
973	1 1/8" RH (turns counter-clockwise)
974	1 1/8" LH (turns clockwise)

### Indicators (Available in Gala Rose and Napa Escutcheon)

Two different variations are available to communicate the status of the door on the outside: Occupied/Vacant or Locked/Unlocked. Available in sectional or escutcheon (shown) styles. Please consult the price book for additional details.



### Allegion Connect

Cross-category solution using common interconnect components for electrified options. Available on the MA851 and MA881 functions including all voltage (12 or 24) and RX options.

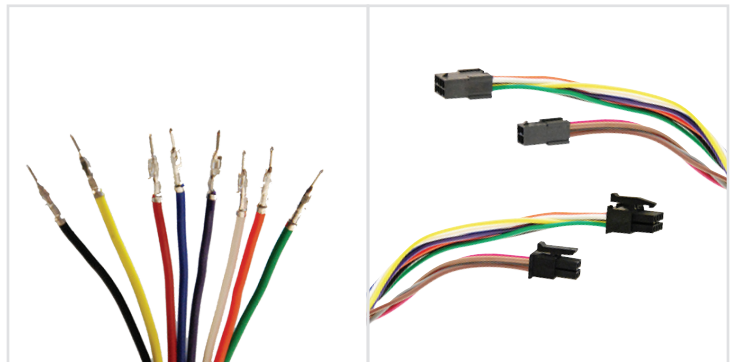

1. Abrasive, knurling and lead wrap options not available on Latitude, Longitude, Broadway and Boardwalk levers.

# H2 Series

Grade 2 interconnected lever lock

Falcon is committed to delivering a solid product at a solid price. The H2 Series is designed for multi-family entry doors and public restroom applications requiring a durable, robust commercial interconnect lock. These interconnected locks feature single motion egress to meet the latest Life and Safety code requirements. The H2 Series is BHMA Grade 2 certified and is available in multiple finishes and lever styles for cohesive styling/ pairing with other Falcon and Schlage products.

## Features

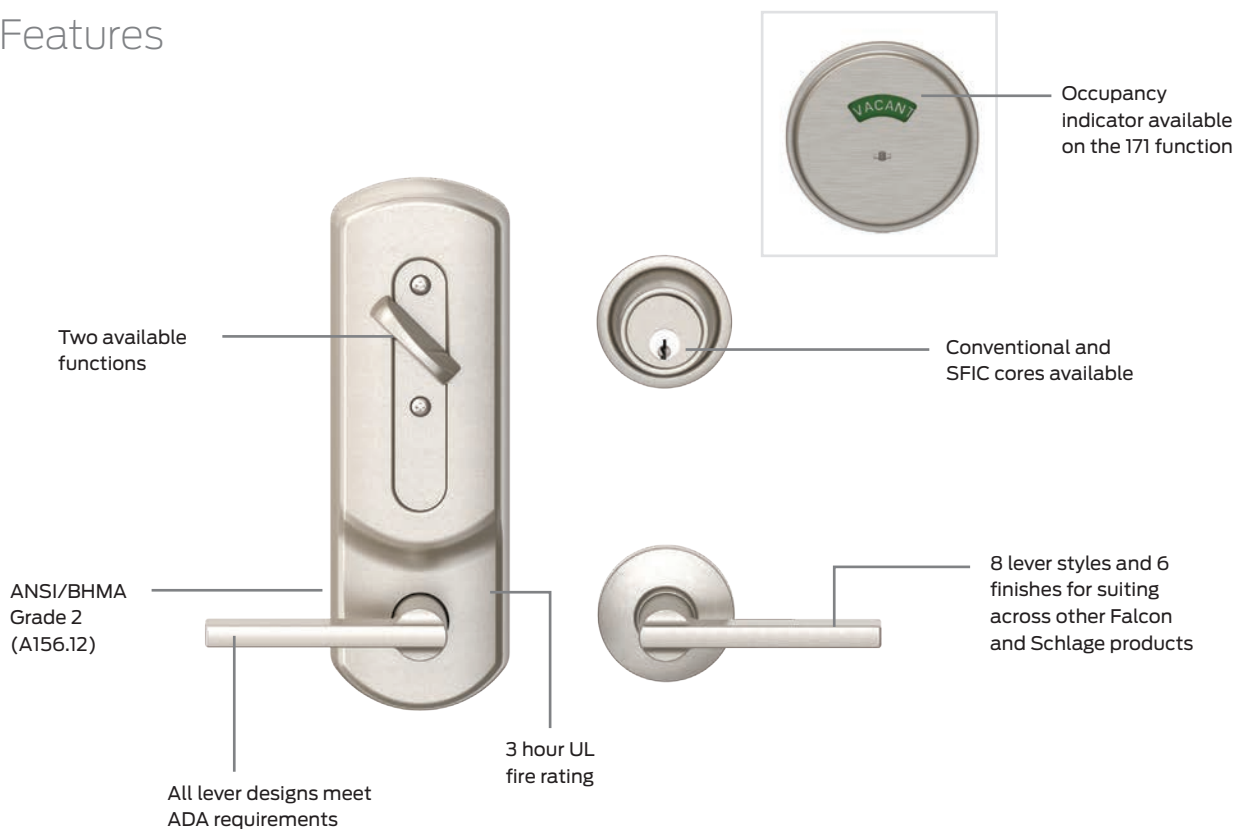

## Specifications

# H2 Series

### Product specifications

**ANSI/BHMA:** Certified ANSI/BHMA A156.12-2013, Grade 2.

**UL:** Listed 3-hour fire door, A label.

**Functions:** 2 commercial functions available.

**Finishes:** 6 options available. See page 6 for finish color and comparative chart.

**Door thickness:** 1 3/4" - 2" door range standard; 1 3/8" available (must be specified).

**Backset:** Adjustable backset fits 2 3/8" or 2 3/4".

**Mechanism:** Cold formed steel, zinc plated and dichromated for rust resistance.

**Attachment:** Outer trims secured to the door by thru-bolts through a steel plate on the inside of the door. Inside escutcheon conceals mounting screws.

**Handing:** Specify hand of door when ordering. Field reversible.

**Cylinders:** Conventional cylinder, drilled with 6-pin chambers, pinned in 5 comes standard. Pinning in 6 chambers available (at no cost) when specified. Optional 7-pin conventional and 6- or 7-pin Small Format Interchangeable Core (SFIC) cylinders. Cylinder housings and plugs machined from solid brass. Springs are phosphor bronze. Two nickel silver keys furnished standard. See SFIC cylinder information on page 8 and H2 Series cylinder pages for additional options.



**Keyways:** "G" keyway standard on conventional cylinders. "A" keyway standard on SFIC cylinders. Additional options: Falcon, Schlage and many Best and Arrow keyways.

**Trim:** Roses are wrought brass, installed over wrought steel reinforcing plates. Levers and escutcheons are zinc.

**Latches:** 1" x 2 1/4" dual option faceplate (square corner standard, round corner included in package). 1" edge bore required. Deadbolt has 1" projection. Adjustable backset fits 2 3/8" or 2 3/4".

**Strikes:** (1) 2 3/4" x 1 1/8" T-strike and (1) 2 3/4" x 1 1/8" lipless strike.

**Center to Center:** Fits 4" or 5 1/2" (field adjustable) center to center door preps

Catalog number	ANSI	Function outside/inside	Name	Description
H2101	F94		Entry single locking	Deadbolt operated by key from outside or by turn from inside. Bolt automatically deadlocks when fully thrown. Latch retracted by lever from either side. Turning inside lever retracts deadbolt and latch simultaneously for immediate exit.
H2171			Public restroom w/occupancy indicator	Deadlocking latch bolt operated by emergency key outside or rotating inside lever. Outside lever rigid. Rotating turn from inside extends dead bolt and changes visual message on outside from vacant to occupied. Both dead bolt and deadlocking latch bolt retract by rotating inside lever.

## Designs and styles

# Lever styles

Most levers can be suited with other Falcon locks and exit device trim. Levers also suite with Schlage residential lever designs, making the Falcon H2 Series perfect for multi-family applications.

Avalon (AVA)



Boardwalk (BRK)



Broadway (BRW)



Dane (DAN)



Flair (FLA)



Latitude (LAT)



Longitude (LON)



Quantum (QUA)



### Finishes

Available in BHMA 605, 619, 622, 625, 626, and 643e. See page 6 for finish color and comparative chart.

### Lever dimensions chart

Lever	A - width	B - projection	C - rose
Avalon (A)	4 1/2"	2 5/8"	10"H x 3 3/8"W
Boardwalk (BRK)	5 1/16"	2 3/4"	10"H x 3 3/8"W
Broadway (BRW)	5 1/16"	2 3/4"	10"H x 3 3/8"W
Dane (D)	4 9/16"	2 1/2"	10"H x 3 3/8"W
Flair (FLA)	4 7/16"	2 1/4"	10"H x 3 3/8"W
Latitude (LAT)	4 13/16"	2 11/16"	10"H x 3 3/8"W
Longitude (LON)	4 13/16"	2 11/16"	10"H x 3 3/8"W
Quantum (Q)	4 5/8"	2 11/16"	10"H x 3 3/8"W

Note: Return to door meets 1/2" requirement for Dane (D) and Quantum (Q) levers.

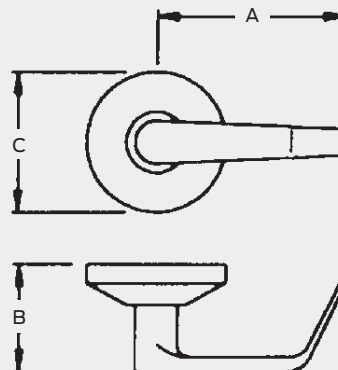

## Options

## H2 Series cylinders

**Falcon Small Format Interchangeable Core (SFIC) cylinders**

Falcon offers a wide selection of keyways in SFIC cylinder formats. Master keying is available and, in most cases, Falcon can even furnish cores master keyed into existing Best or Arrow key systems. See page 8 for details.

**To order conventional cylinders in competitive keyways (6-pin)**

When specifying a competitive cylinder, reference How-to-order page for correct cylinder suffix and be sure to list brand plus keyway under the "Keyway" section and the correct part number below in the "Other requirements" area of the part number order string.

Brand	Keyway	Cylinder 6-Pin			Function
		O-Bit	KA	KD	
Schlage	C	Q100-108	Q100-108-KA	Q100-108-KD	H2101

## Strikes

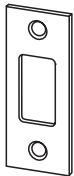
**Deadbolt strikes**

**10-094**  
1 1/8" x 2 3/4"  
Square corner  
(standard)

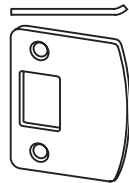

**10-092**  
1 5/8" x 2 1/4"  
1/4" radius corner  
full lip

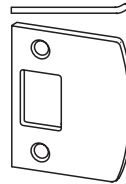

**10-095**  
1 5/8" x 2 1/4"  
Square corner  
full lip

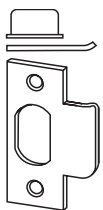

**10-116**  
1 1/8" x 2 3/4"  
Round corner  
full lip

**Deadlatch strikes**

**10-001**  
1 1/8" x 2 3/4"  
Square corner  
(standard)

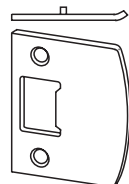

**10-026**  
1 5/8" x 2 1/4"  
Square corner  
full lip

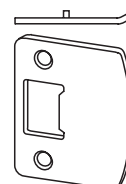

**10-027**  
1 5/8" x 2 1/4"  
1/4" radius corner  
full lip

# D Series

Grade 1 and Grade 2 deadbolts

Deadbolt locks provide an extra measure of protection against break-in when used as a supplement to an existing lockset. In applications ranging from military and government projects to multi-family housing, retail and restaurants, Falcon deadbolts deliver superior performance and the flexibility of multiple keying systems. Our full line of Grade 1 and 2 auxiliary locks feature interchangeable cores that are compatible with SFIC products from other manufacturers. Plus they're backed by Allegion, the best name in the business.

## Features

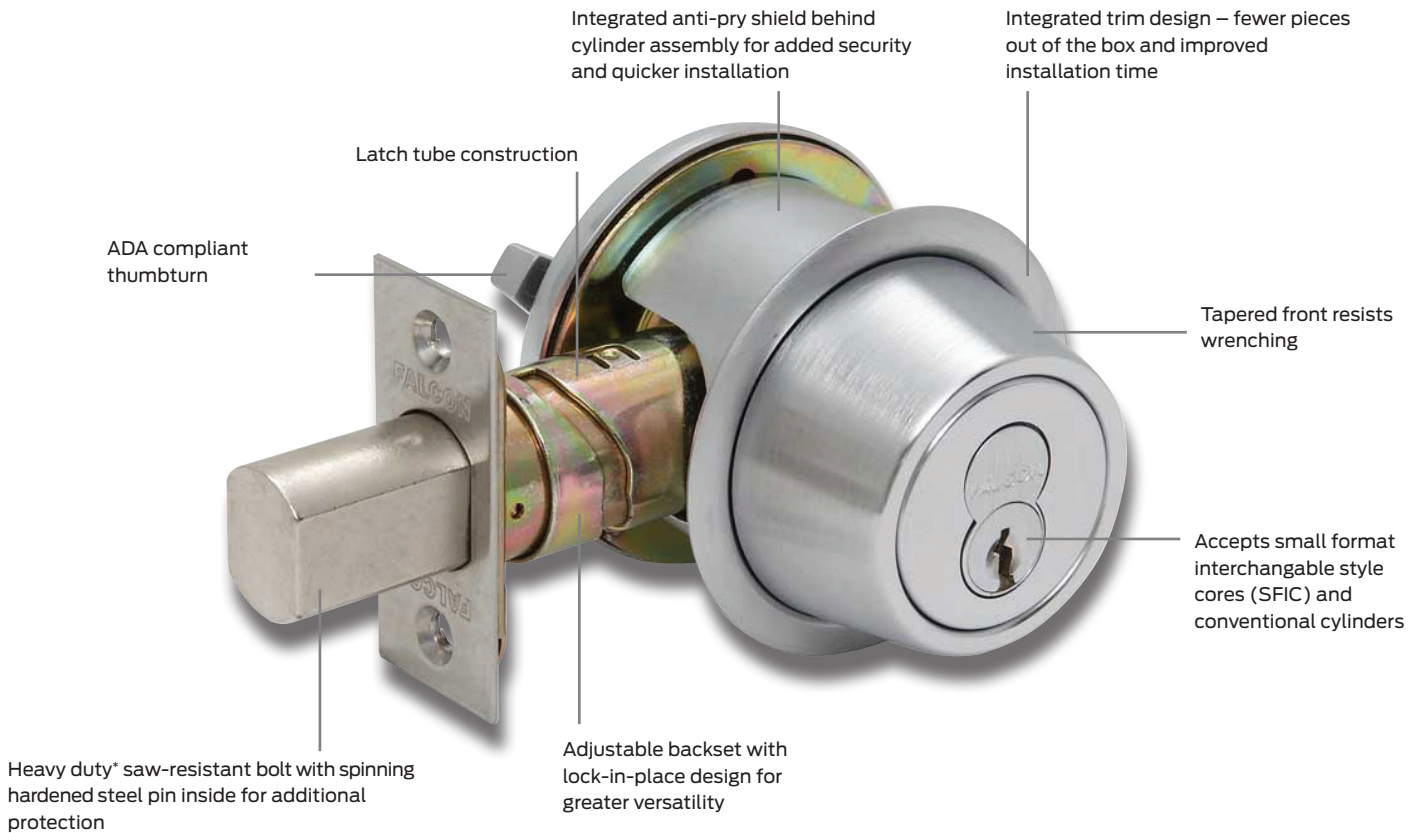

\*Grade 1 - High strength steel - powdered  
Grade 2 - Zinc

## Ordering information

# How to order

For correct ordering and to help ensure no delays in the shipment of your product, follow the information sequence below. Additional information for each category can be found on other pages of this catalog and in the Falcon price book. Cylindrical, mortise and interconnected lock ordering information can be found on page 7.

### Examples: FAL-D211P6-625-619-Schlage C-Q033-069-KD

Brand		Product number			Finish		Door detail				Keyway	Other requirements
1	2	3	4	5	6	7	8	9	10	11	12	13
	Series	Func	Cylinder suffix	Fire rated	Outside	Inside	Deadbolt part #	Strike part #	Door thickness <sup>1</sup>	Extension	Keyway	Examples <sup>2</sup>
FAL	- D	211	P6		625	- 619					Schlage C	- Q033-069-KD
FAL	- D	141	P6	F	625	-	30-259	10-064			Russwin D1	- Q033-072-KD

Defaults to factory standard if not specified.

1. Enter door thickness if non-standard. Examples: 2 1/2" = 212; 2 1/4" = 214.

2. Examples include: Competitive keyway cylinder part number, master keying requirements, Blockokey.

### Detail

1	<b>Brand:</b> Falcon=FAL																				
2	<b>Series:</b> Lock series = D																				
3	<b>Function:</b> Choose from function lists (pages 57 and 59).																				
4	<b>Cylinder suffix:</b> Choose cylinder type <table border="0"> <tr> <td><b>B</b></td> <td>Less SFIC</td> <td><b>L</b></td> <td>Less 6-pin conventional cylinder</td> </tr> <tr> <td><b>BB</b></td> <td>SFIC, Best style</td> <td><b>P</b></td> <td>6-pin conventional cylinder (pinned to 5)</td> </tr> <tr> <td><b>BDC</b></td> <td>SFIC disposable construction core</td> <td><b>P6</b></td> <td>6-pin conventional cylinder (pinned to 6)</td> </tr> <tr> <td><b>G<sup>1</sup></b></td> <td>SFIC, Falcon style<sup>1</sup></td> <td><b>P7</b></td> <td>7-pin conventional cylinder (pinned to 7)</td> </tr> <tr> <td><b>H</b></td> <td>SFIC refundable construction core</td> <td><b>CP6</b></td> <td>6-pin conventional cylinder, Schlage C</td> </tr> </table>	<b>B</b>	Less SFIC	<b>L</b>	Less 6-pin conventional cylinder	<b>BB</b>	SFIC, Best style	<b>P</b>	6-pin conventional cylinder (pinned to 5)	<b>BDC</b>	SFIC disposable construction core	<b>P6</b>	6-pin conventional cylinder (pinned to 6)	<b>G<sup>1</sup></b>	SFIC, Falcon style <sup>1</sup>	<b>P7</b>	7-pin conventional cylinder (pinned to 7)	<b>H</b>	SFIC refundable construction core	<b>CP6</b>	6-pin conventional cylinder, Schlage C
<b>B</b>	Less SFIC	<b>L</b>	Less 6-pin conventional cylinder																		
<b>BB</b>	SFIC, Best style	<b>P</b>	6-pin conventional cylinder (pinned to 5)																		
<b>BDC</b>	SFIC disposable construction core	<b>P6</b>	6-pin conventional cylinder (pinned to 6)																		
<b>G<sup>1</sup></b>	SFIC, Falcon style <sup>1</sup>	<b>P7</b>	7-pin conventional cylinder (pinned to 7)																		
<b>H</b>	SFIC refundable construction core	<b>CP6</b>	6-pin conventional cylinder, Schlage C																		
5	<b>Fire rated:</b> Indicate with an "F" if fire rated deadbolt is desired and specify part number under section 8. See page 60 for deadbolt options.																				
6	<b>Outside finish:</b> Choose outside finish from available options.																				
7	<b>Inside finish:</b> Fill in inside finish only if different from outside.																				
8	<b>Deadbolt part number:</b> See page 60 for options. Specify only if non-standard deadbolt is required. Specify LLL for less deadbolt.																				
9	<b>Strike part number:</b> See page 60 for options. Specify only if non-standard strike is required. Specify LLL for less strike.																				
10	<b>Door thickness:</b> 1 7/8" standard for conventional cylinder and thumbturn. 1 5/8" to 2 1/4" standard for SFIC cylinder. Specify only if non-standard door thickness is required.																				
11	<b>Extension:</b> Enter one of the following when door specified is 2" or greater. (EI or EO assumes the latch will be centered on a 1 3/4" door to which material has been added.) <table border="0"> <tr> <td><b>EE</b></td> <td>Extended Equally</td> <td><b>EI</b></td> <td>Extended Inside</td> </tr> <tr> <td><b>EO</b></td> <td>Extended Outside</td> <td><b>ED</b></td> <td>Extended Differently</td> </tr> </table>	<b>EE</b>	Extended Equally	<b>EI</b>	Extended Inside	<b>EO</b>	Extended Outside	<b>ED</b>	Extended Differently												
<b>EE</b>	Extended Equally	<b>EI</b>	Extended Inside																		
<b>EO</b>	Extended Outside	<b>ED</b>	Extended Differently																		
12	<b>Keyway:</b> G keyway (KD) is standard when ordering P, P6 or P7 conventional cylinders; A keyway (KD) is standard when ordering BB, BDC, G or H SFIC cylinders. Other keyways available.																				
13	<b>Additional requirements:</b> <ul style="list-style-type: none"> <li>▪ Competitive keyway cylinders: Specify part number<sup>2</sup></li> <li>▪ Keying detail: Blockokey or additional keys (with quantity) requests, large bow keys, master keying (Example: Grand Master keyed, Master keyed, change key, etc.)</li> </ul>																				

1. 6-pin standard, specify G7 if 7-pin is desired.

2. Specify P6 and list the cylinder part number under "Other requirements" if a 6-pin competitive keyway cylinder is desired (see page 60 for options).

## Specifications

# D100 Series

## Grade 1, heavy-duty deadbolts

**Product specifications**

**ANSI/BHMA Standard:** A156.5, 2001, Grade 1.

**UL:** UL listed for 3-hour fire door

**Functions:** 5 commercial functions available.

**Finishes:** 5 options available. See page 6 for finish color and comparative chart.

**Door thickness:**  $1\frac{7}{8}$ " standard conventional cylinder and thumbturn only.  $1\frac{5}{8}$ " to  $2\frac{1}{4}$ " SFIC cylinder.

**Backsets:**  $2\frac{3}{8}$ " -  $2\frac{3}{4}$ " adjustable deadbolt.

**Attachment:** Locks are solidly attached to the door by  $\frac{1}{4}$ " heat-treated steel bolts. These bolts pass through a steel plate (D111, D121 and D141) or the inner cylinder housing (D131) and thread directly into the back of the outer cylinder housing. A permanent cap is inserted over the inside cylinder (D131) making the bolts nearly impossible to remove.

**Handing:** Locks are non-handed.

**Cylinders:** Conventional cylinder, drilled with 6-pin chambers, pinned in 5 comes standard. Pinning in 6 chambers available (at no cost) when specified. Optional 7-pin conventional and 6- or 7-pin Small Format Interchangeable Core (SFIC) cylinders. Cylinder housings and plugs machined from solid brass. Springs are phosphor bronze. Two nickel silver keys furnished standard. See SFIC cylinder information on page 8 and D Series cylinder pages for additional options.

**Keyways:** "G" keyway standard in conventional cylinders. "A" keyway standard in SFIC cylinders. Additional options: Falcon, Schlage and many Best and Arrow keyways.

**Exposed trim:** Wrought brass or bronze reinforced with steel insert.

**Deadbolts:** Deadbolt locks are furnished with deadbolts which have a full 1" projection. Housed within the deadbolt is a free-turning,  $\frac{1}{4}$ " thick, hardened steel, saw-resistant roller. Furnished standard with  $2\frac{3}{8}$ " -  $2\frac{3}{4}$ " adjustable backset and  $1\frac{1}{8}$ " x  $2\frac{1}{4}$ " faceplate. Optional 1" x  $2\frac{1}{4}$ " faceplate. Consult Options and Accessories section for other optional faceplates. D100 bolt is high strength steel.

**Strikes:**  $2\frac{3}{4}$ " x  $1\frac{1}{8}$ " lipless strike standard. ANSI  $4\frac{7}{8}$ " x  $1\frac{1}{4}$ " lipless,  $2\frac{1}{4}$ " full lip strikes, a  $2\frac{3}{4}$ " x  $1\frac{1}{8}$ " T-strike or a security strike are available. Consult options and accessories section.

**Screws:** Furnished with wood/machine screws for use on wood or metal doors or frames.

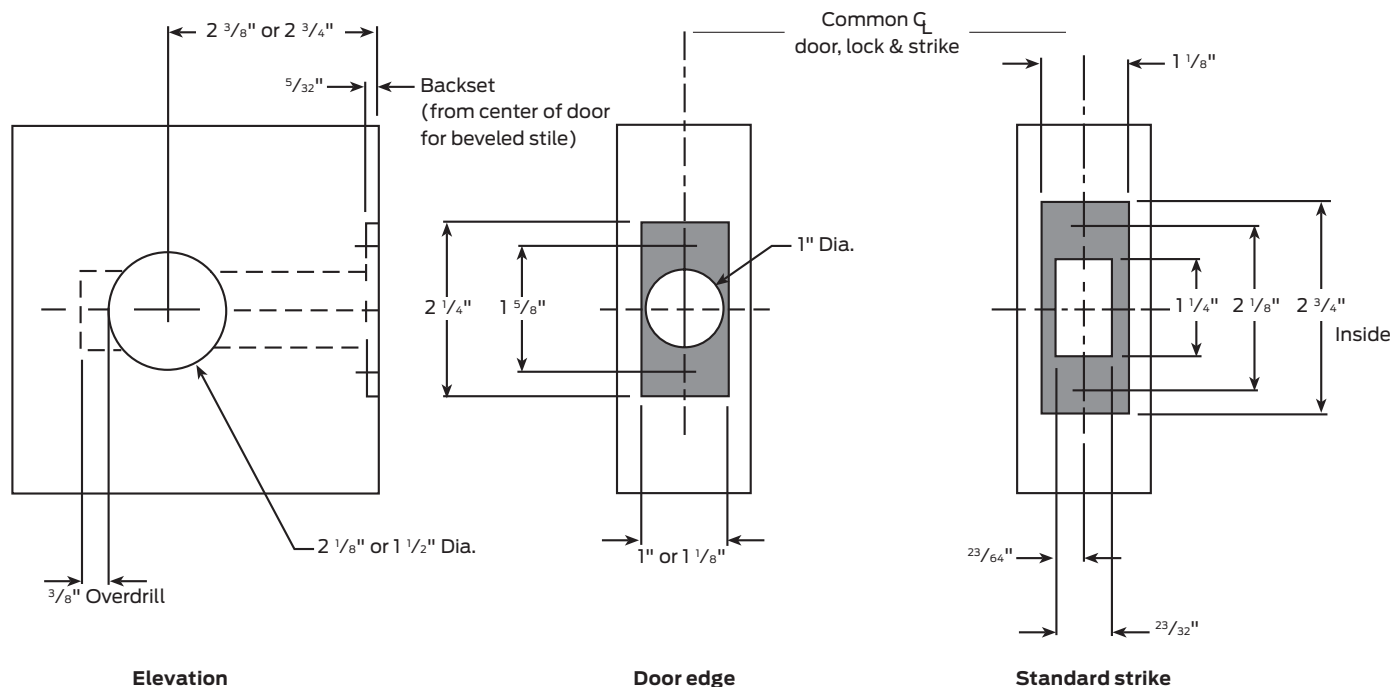



## Functions

# D100 Series styles

### D111: Classroom function

Deadbolt thrown or retracted by key from outside. Inside turn will only retract bolt. Bolt automatically deadlocks when fully thrown.

ANSI/BHMA E0171



### D121: Single cylinder

Deadbolt thrown or retracted by key only. Blank plate inside. Bolt automatically deadlocks when fully thrown.

ANSI/BHMA E0161



### D131: Double cylinder

Deadbolt thrown or retracted by key from either side. Bolt automatically deadlocks when fully thrown.

ANSI/BHMA E0141

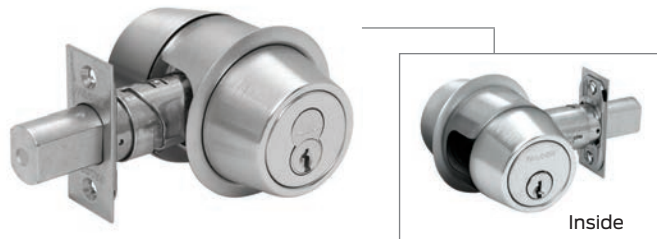

### D141: Single cylinder x thumbturn

Deadbolt thrown or retracted by key or by turn. Bolt automatically deadlocks when fully thrown.

ANSI/BHMA E0151



### D151: Double thumbturn

Deadbolt thrown or retracted by turn unit from either side. Bolt automatically deadlocks when fully thrown. Application for shelters.

#### Finishes

Available in BHMA 605, 606, 613, 625, and 626. See page 6 for finish color and comparative chart.

## Specifications

# D200 Series

## Grade 2, medium-duty deadbolts

### Product specifications

**ANSI/BHMA:** A156.5, 2001, Grade 2.

**Functions:** 8 commercial functions available.

**Finishes:** 5 options available. See page 6 for finish color and comparative chart.

**Door thickness:** 1 <sup>3</sup>/<sub>8</sub>" to 2 <sup>1</sup>/<sub>4</sub>" standard conventional cylinder. 1 <sup>5</sup>/<sub>8</sub>" to 2" SFIC cylinder.

**Backsets:** 2 <sup>3</sup>/<sub>8</sub>"- 2 <sup>3</sup>/<sub>4</sub>" adjustable deadbolt.

**Attachment:** Locks are solidly attached to the door by <sup>1</sup>/<sub>4</sub>" heat-treated steel bolts. These bolts pass through a steel plate (D211, D221 and D241) or the inner cylinder housing (D231) and thread directly into the back of the outer cylinder housing.

**Handing:** Non-handed. May be used in right hand or left hand doors swinging in or out.

**Cylinders:** Conventional cylinder, drilled with 6-pin chambers, pinned in 5 comes standard. Pinning in 6 chambers available (at no cost) when specified. Optional 7-pin conventional and 6- or 7-pin Small Format Interchangeable Core (SFIC) cylinders. Cylinder housings and plugs machined from solid brass. Springs are phosphor bronze. Two nickel silver keys furnished standard. See SFIC cylinder information on page 8 and D Series cylinder pages for additional options.

**Keyways:** "G" keyway standard in conventional cylinders. "A" keyway standard in SFIC cylinders. Additional options: Falcon, Schlage and many Best and Arrow keyways.

**Exposed trim:** Wrought brass or bronze reinforced with steel insert.

**Deadbolts:** Deadbolt locks are furnished with deadbolts which have a full 1" projection. Housed within the deadbolt is a free-turning, <sup>1</sup>/<sub>4</sub>" thick, hardened steel, saw-resistant roller. Furnished standard with 2 <sup>3</sup>/<sub>8</sub>"- 2 <sup>3</sup>/<sub>4</sub>" adjustable backset and <sup>1</sup>/<sub>8</sub>" x 2 <sup>1</sup>/<sub>4</sub>" faceplate. Optional 1" x 2 <sup>1</sup>/<sub>4</sub>" faceplate. Consult Options and Accessories section for other optional faceplates. D200 bolt is cast zinc.

**Strikes:** 2 <sup>3</sup>/<sub>4</sub>" x <sup>1</sup>/<sub>8</sub>" lipless standard. ANSI 4 <sup>7</sup>/<sub>8</sub>" x <sup>1</sup>/<sub>4</sub>" lipless, 2 <sup>1</sup>/<sub>4</sub>" full lip strikes, a 2 <sup>3</sup>/<sub>4</sub>" x <sup>1</sup>/<sub>8</sub>" T-strike or a security strike are available. Consult Options and Accessories section.

**Screws:** Furnished with wood/machine screws for use on wood or metal doors or frames.

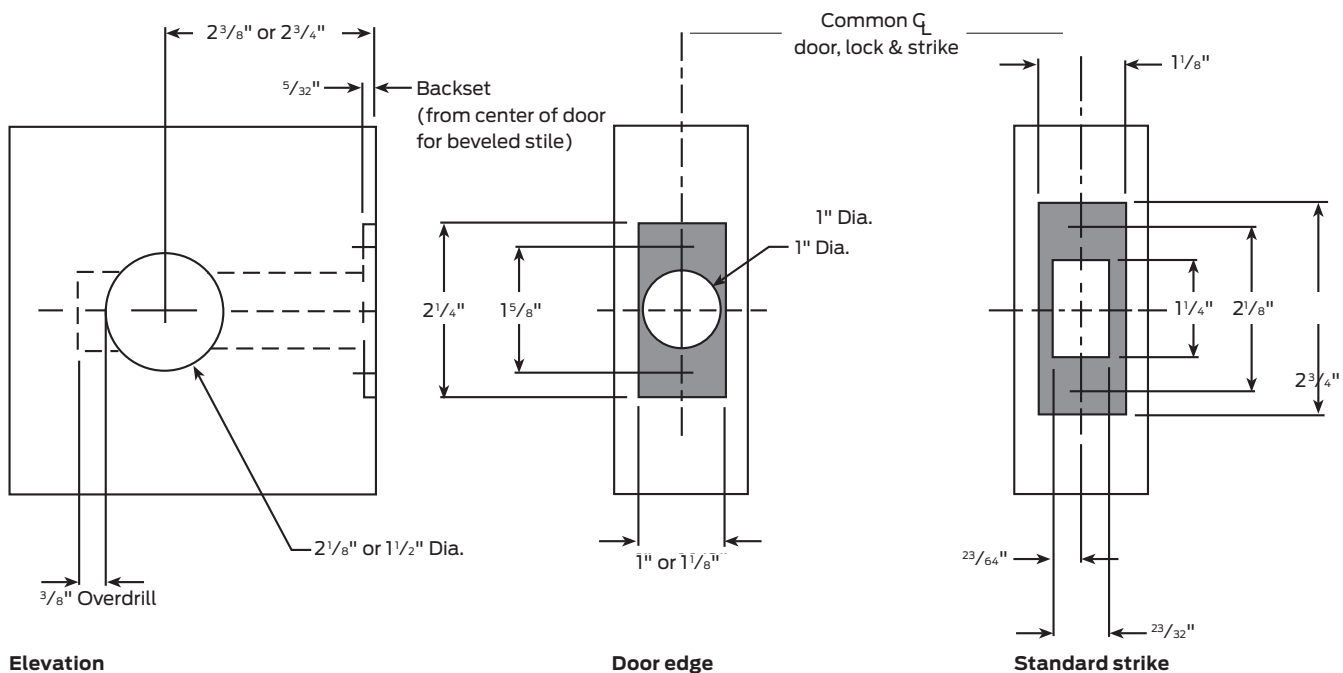

## Functions

# D200 Series styles

### D211: Classroom function

Deadbolt thrown or retracted by key from outside. Inside turn will only retract bolt. Bolt automatically deadlocks when fully thrown.

ANSI/BHMA E0172



### D221: Single cylinder

Deadbolt thrown or retracted by key only. Blank plate inside. Bolt automatically deadlocks when fully thrown.

ANSI/BHMA E016



### D231: Double cylinder

Deadbolt thrown or retracted by key from either side. Bolt automatically deadlocks when fully thrown.

ANSI/BHMA E0142



### D241: Single cylinder with thumbturn

Deadbolt thrown or retracted by key or by turn. Bolt automatically deadlocks when fully thrown.

ANSI/BHMA E0152



### D251: Double thumbturn

Deadbolt thrown or retracted by turn unit from either side. Bolt automatically deadlocks when fully thrown. Application for shelters.

### D261: Thumbturn (inside only) ANSI/BHMA E0192

### D261M: Thumbturn with rose ANSI/BHMA E01112

Deadbolt thrown or retracted by turn unit only. No outside trim (D261), or outside blank rose (D261M). Bolt automatically deadlocks when fully thrown.



### D271: Thumbturn (Inside with occupancy indicator)

Deadbolt thrown or retracted by turn unit only. Occupancy indicator on outside (reads either in use or vacant with color coding). Bolt automatically deadlocks when fully thrown. Emergency key supplied.



#### Finishes

Available in BHMA 605, 606, 613, 625, and 626. See page 6 for finish color and comparative chart.

## Options

## D Series cylinders

**Falcon Small Format Interchangeable Core (SFIC) cylinders**

Falcon offers a wide selection of keyways in SFIC cylinder formats. Master keying is available and, in most cases, Falcon can even furnish cores master keyed into existing Best or Arrow key systems. See page 8 for details.

**To order conventional cylinders in competitive keyways (6-pin)**

When specifying a competitive cylinder, reference How-to-order page for correct cylinder suffix and be sure to list brand plus keyway under the "Keyway" section and the correct part number below in the "Other requirements" area of the part number order string.

Brand	Keyway	O-Bit	KA	KD	Lock function
Corbin	60	Q033-077		Q033-077-KD	D141/241
Corbin	L4	Q033-079			D121/221
Russwin		Q033-078			
Russwin	D1	Q033-074		Q033-074-KD	D121/221
		Q033-073		Q033-073-KD	D131/231
		Q033-072		Q033-072-KD	D141/241
		Q033-065			D111
Schlage	C 5-pin	Q500-065			D111
		Q500-071			D131
	C 6-pin	Q033-071		Q033-071-KD	D121/221
		Q033-070	Q033-070-KA	Q033-070-KD	D131/231
		Q033-069	Q033-069-KA	Q033-069-KD	D111/211
		Q033-066			D121/221
E 6-pin	Q033-067			D131/231	
	Q033-068			D121/221	
Yale	8 (Para)			Q033-076-KD	D121/221
				Q033-075-KD	D141/241 D111/211

## Deadbolts

Options for configured locks.

	D100	D200	Adjustable backset	Description
Non-fire rated	30-256	30-253	2 3/8" or 2 3/4"	Square corner, 1 1/8" x 2 1/4", standard
	30-176	30-175	2 3/8" or 2 3/4"	Square corner, 1" x 2 1/4"
	30-178	30-177	2 3/8" or 2 3/4"	Radius corner (1/4"), 1" x 2 1/4"
	30-257	30-254	2 3/8" or 2 3/4"	Circular drive-in bolt (626 finish only)
UL listed	30-174	30-173	2 3/8" or 2 3/4"	Square corner, 1 1/8" x 2 1/4", standard
	30-172	30-171	2 3/8" or 2 3/4"	Square corner, 1" x 2 1/4"
	30-259	30-258	2 3/8" or 2 3/4"	Circular drive-in bolt (626 finish only)

Note: Specify finish 605, 606, 613, 625, or 626.

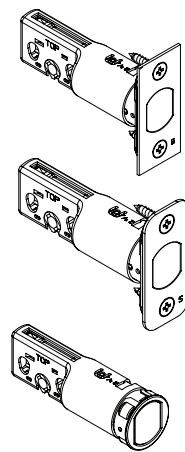

## Strikes

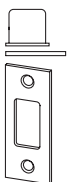

**10-094**  
Square corner with metal dustbox (standard)

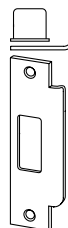

**10-087**  
ANSI prep with dustbox

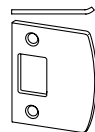

**10-095**  
Full lip, square corner

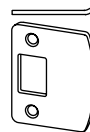

**10-092**  
Full lip, 1/4" radius corner



**10-064**  
Drive-in thimble

**10-095**  
Full lip, square corner

# K900 Series

## Padlocks

A pin tumbler padlock manufactured from solid bar stock brass, with chrome-plated, case-hardened steel shackle. The entire cylinder assembly is removable for easier rekeying or quick cylinder change. Note: Key is removable in locked position. Padlocks with longer shackles (2" or 6") available when specified. 1" shackle is standard.

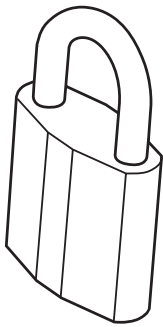

955 Deadlocking type padlock

**Cylinders:** Furnished with solid brass plug and housing, drilled with 6-pin chambers, pinned in 5 unless otherwise specified. Also available with 7-pin cylinder. Furnished with two (2) nickel silver keys standard.

**Keyways:** "G" keyway standard on standard cylinders. Interchangeable core (SFIC) padlocks, branded Schlage, are also available. See pricebook for details.

# Notes

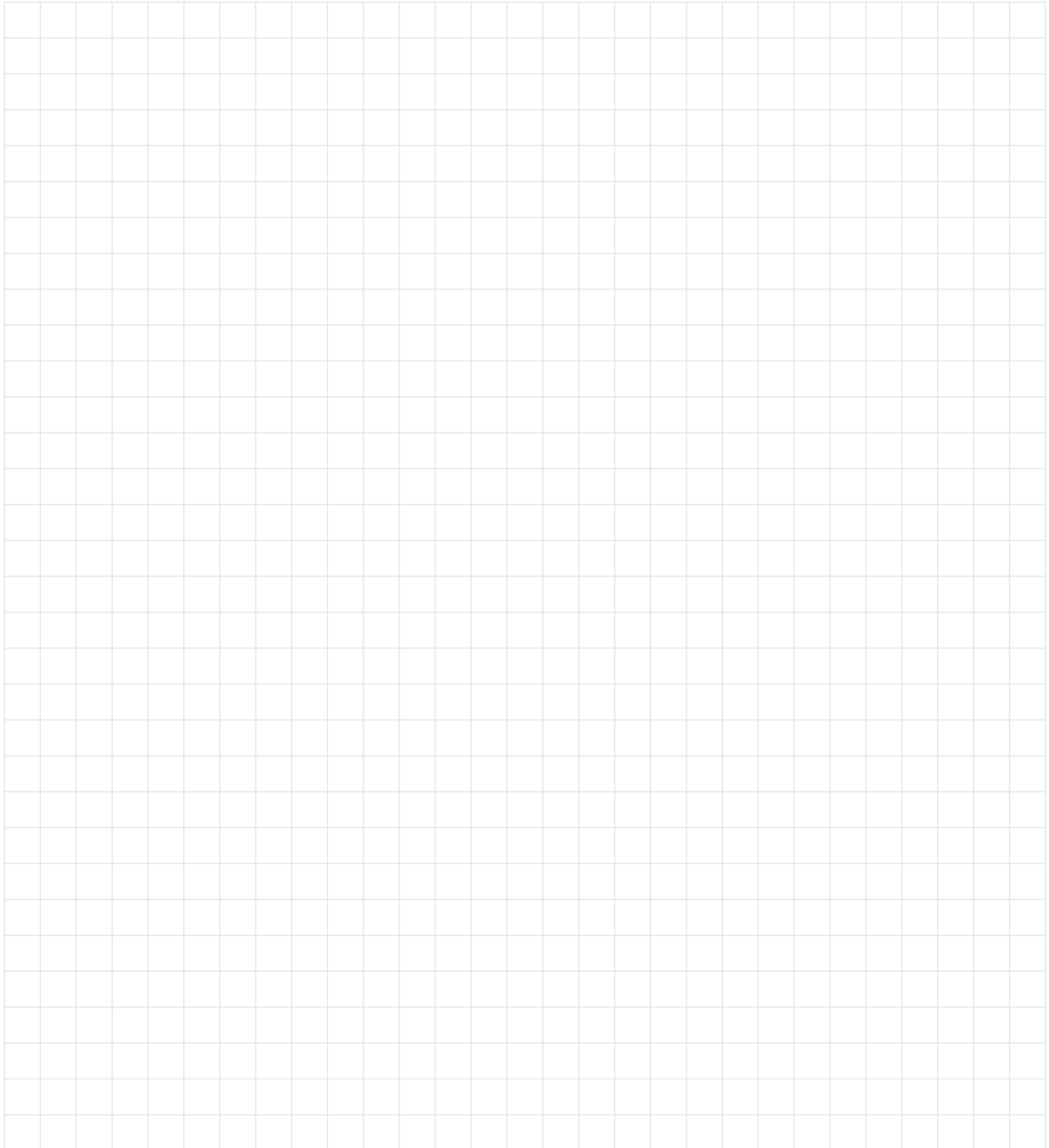

This page is intentionally left blank.

**| ips**